



Washoe County School District

**Project Title:
Site Drainage Improvements
at Roy Gomm Elementary School**

**Bid #:
25-100-B-04-BC**

**Date:
April 10, 2025**

**Prepared By:
Purchasing Department
14101 Old Virginia Road, Room 0
Reno, NV 89521
Phone: (775) 850-8025
Fax: (775) 857-3175
E-Mail: solicitations@washoeschools.net**

SECTION 00090 - NOTICE TO CONTRACTORS

Sealed bids for the **Site Drainage Improvements at Roy Gomm Elementary School** will be received by the Washoe County School District's (WCSD) Purchasing Department located at the Brown Center 14101 Old Virginia Road, Room #0, Reno, NV 89521, **until 2:00 p.m., (Local Time) on May 9, 2025**. The bids will be opened publicly via a TEAMS Meeting at **2:30 p.m. (local time)**.

[Join the meeting now](#)

Meeting ID: 253 600 565 237

Passcode: qR22SJ2M

Scope of Work: Site improvements include constructing a concrete channel, rip-rap swale, P.C.C. valley gutter, sidewalk cross-drain, regrading with installation of rip-rap reinforcing, relocating and refilling metal garden beds, removal of trees as needed for construction, installation of new fencing, and clearing of all site's existing drainage infrastructure.

Contractors desiring to bid on this work shall be contractors presently licensed by the Nevada State Contractors Board and shall maintain a valid Contractor's License for the duration of the construction project. In addition, any and all Subcontractors that will be utilized by the Contractor shall also be presently licensed by the Nevada State Contractors Board and shall maintain a valid license for the duration of the construction project. All licensing requirements as specified in Nevada Revised Statutes (NRS) [Chapter 624](#) shall also be strictly adhered to. Contractors shall also carry and provide evidence of required insurance liability coverage as specified in the Liability Insurance Specifications, as identified in Section 00800 – SUPPLEMENTARY GENERAL CONDITIONS.

NOTE: The Facilitating Buyer for this solicitation is named below. Interested parties may NOT contact anyone else regarding this solicitation. Any interested Bidder contacting any other individual including, but not limited to, WCSD staff, officials, evaluation committee members, or Board of Trustees may have their Bid submission rejected from evaluation and award consideration.

Plans and specifications are available to view and download at WCSD's Purchasing Department website at <http://solicitations.washoeschools.net/>.

There will be a NON-MANDATORY Pre-Bid Meeting held at 8:00 a.m. on April 24, 2025, at Roy Gomm Elementary School (Meet in Front of The Office) 4000 Mayberry Drive, Reno, NV 89519. Due to access and coordination involved in this project we highly recommend that contractors walk the project site that we are making available.

The physical work is to be commenced upon issuance of a "Notice to Proceed". Work shall be completed on or before **August 1, 2025**.

Bid #: 25-100-B-04-BC

Date: 9/23/24

PUR-F522

Page 2 of 66

PWP #: WA-2025-310

Facilitating Buyer: Bill Conn
Email: solicitations@washoeschools.net

To be published in the Reno Gazette Journal on April 10, 2025.

Washoe County School District
Purchasing Department
14101 Old Virginia Road, Room #0
Reno, NV 89521

Phone: 775-850-8025
Fax: 775-857-3175

Email: solicitations@washoeschools.net

CONTENTS

PUR-F522

Site Drainage Improvements at Roy Gomm Elementary School

DIVISION 0			PAGES
Section 00100	Instructions to Bidders		6 – 8
	Special Notifications		9 – 11
Section 00400	Sample Bid Bond	PUR-F525	12 – 13
Section 00500	Sample Contract	PUR-F532	14 – 15
Section 00600	Sample Labor and Materials Bond	PUR-F526	16 – 17
Section 00610	Sample Performance Bond	PUR-F527	18 – 19
Section 00700	General Conditions		20
Section 00800	Supplementary General Conditions		21 – 44
Section 00810	Wage Rates and Apprentice Utilization		45
Section 00820	Special Conditions		46 – 64
Section 00830	Technical Specifications		65 – 66
2024 – 2025 Balanced School Calendar		Total Pages	1
2025 – 2026 Balanced School Calendar		Total Pages	1
FORMS REQUIRED AT BID OPENING WITH BID SUBMISSION			
Bid Form	PUR-F523	Total Pages	5
Preferential Bidder Status Affidavit	PUR-F524	Total Pages	2
Public Disclosure Form	PUR-F210	Total Pages	1
Bid Bond	PUR-F525	Total Pages	2
FORMS REQUIRED FROM AWARD CONTRACTOR			
Labor and Materials Bond	PUR-F526	Total Pages	2
Performance Bond	PUR-F527	Total Pages	3
DIVISION 1			
Section 01001	Construction Procedures for Existing School Sites	Total Pages	2
Section 01010	Summary of Work	Total Pages	2

Section 01015	Schedule of Drawings	Total Pages	1
Section 01020	Personnel Safety Check Application	Total Pages	2
Section 01027	Application for Payment	Total Pages	7
Section 01035	Modification Procedures	Total Pages	7
Section 01040	Coordination	Total Pages	6
Section 01041	Project Management Software	Total Pages	5
Section 01045	Cutting and Patching	Total Pages	5
Section 01050	Field Engineering	Total Pages	4
Section 01110	Prevailing Wage Specifications	Total Pages	14
2025 Prevailing Wage Rates (Washoe County, NV)		Total Pages	66
Amendments		Total Pages	1
Section 01200	Project Meeting	Total Pages	6
Section 01300	Submittals	Total Pages	10
Section 01310A	Progress Schedules	Total Pages	8
Section 01400	Quality Control	Total Pages	4
Section 01420	References	Total Pages	6
Section 01600	Materials and Equipment	Total Pages	6
Section 01631	Substitutions	Total Pages	6
Section 01700	Contract Closeout	Total Pages	7
Section 01710	Final Cleaning	Total Pages	4
TECHNICAL SPECIFICATIONS – ODYSSEY ENGINEERING INCORPORATED			
Engineering's Scope of Work Narrative		Total Pages	4
HAZARDOUS MATERIALS SPECIFICATIONS			
Material, Water & Lead Disturbance Permit(s)		Total Pages	9
FACS – Asbestos & Lead Survey Report		Total Pages	64
FACS – Hazardous Material Specifications		Total Pages	9

SECTION 00100 - INSTRUCTION TO BIDDERS

Bids must be submitted in accordance with the following instructions to be considered for review and award.

Bids shall be submitted on the provided Bid Form (PUR-F523) only, and all of the blank spaces shall be completed; numbers shall be stated both in writing and in figures, the signature shall be in longhand; and the completed form shall be without interlineation, alteration or erasure. **Any bid submission will be disqualified and rejected if the bid submission is not signed.**

Washoe County School District only accepts signatures done manually (also known as a wet signature) or electronic digital signatures that are certified. Non-certified electronic digital signatures will NOT be accepted. A typed signature, even in cursive font, DOES NOT meet the requirements of an official digital signature. A digital signature must be accompanied by a certified digital stamp issued through programs like Adobe Acrobat, Docu-Sign or other similar programs that produce a digital stamp certifying the electronic digital signature. Any signatures on required forms that do not meet these requirements will not be accepted and the Contractor's submission will be deemed "Non-Responsive" and will be rejected. If you have any questions about this requirement, please submit your question by the question deadline, so that it can be answered prior to the bid submission deadline.

In the event of a discrepancy on the Bid Form, NRS 104.3114 Contradictory terms of instrument states that, "If an instrument contains contradictory terms, typewritten terms prevail over printed terms, handwritten terms prevail over both, and words prevail over numbers." No additional pages containing inclusions, exclusions or clarifications will be accepted as part of the bid. Any clarifications, additions or exclusions made by the Washoe County School District (WCSD – OWNER) will be considered incorporated into the specifications.

The Contractor is responsible for ensuring he/she has received and reviewed the entire bid package, including all specifications, plans and any/all issued Addendums.

Bids shall be addressed to the WCSD and delivered to the office of the Purchasing Department, located at the Brown Center, 14101 Old Virginia Road, Room #0, Reno, Nevada 89521, **until 2:00 p.m., (Local Time) on May 9, 2025**. Bids shall be delivered sealed in an opaque envelope. The outside of the envelope shall be clearly marked to indicate the bid for the proposed work and directed to the Purchasing Department. The bids will be opened publicly via a TEAMS Meeting at 2:30 p.m.

Each individual bid shall be accompanied by a surety company issued Bid Bond or by a Certified or Cashier's Check made payable to the *Washoe County School District*, in the amount of not less than five percent (5%) of the bid, said amount to be forfeited to WCSD, should the Contractor to whom the Contract is awarded fail to enter into the Contract in accordance with the Contractor's bid and any other contract documents and furnish the required bonds within ten (10) days after the delivery of notice of such award. Bid Bonds, upon request, or deposits of the unsuccessful bidders will be returned upon signing of Contract, or within forty-five (45) days from bid date, whichever is earlier.

Contractors desiring to bid on this work shall be Contractors presently licensed by the Nevada State Contractors Board and shall maintain a valid Contractor's license for the

duration of the construction project. In addition, any and all Subcontractors that will be utilized by the Contractor shall also be presently licensed by the Nevada State Contractors Board and shall maintain a valid license for the duration of the construction project. All licensing requirements as specified in NRS [Chapter 624](#) shall also be strictly adhered to.

WCSD requires that all Contractors who work on construction projects have in place a Drug and Alcohol Policy and this shall be acknowledged by signature on the Bid Form (PUR-F523).

The physical work is to be commenced upon issuance of a "Notice to Proceed". Work shall be completed on or before **August 1, 2025**.

Contractor must agree that Owner may retain from the monies due the Contractor One Thousand Dollars (\$1,000) per day (Liquidated Damages) as a direct result of the Contractor's delay or for not completing the project in the required time allowance plus approved time extensions.

The right is reserved by WCSD to reject any and all bids or accept the bid, which is deemed by WCSD to be in the best interest of the school district. WCSD also reserves the right to waive any irregularities and/or informalities in the submitted bids.

Should a Contractor find discrepancies in, or omissions from, the drawings or documents, or should he/she be in doubt as to the meanings of said documents, he/she should immediately notify the Owner in writing via Email to solicitations@washoeschools.net, whereas the Owner will send written instruction via Addendum to all Contractors. The Owner, Architect/Engineer, Project Manager, Assistant Project Manager, or any other WCSD staff member will not be held responsible for any oral instructions provided during the bid submission process.

Before submitting a bid, Contractors shall carefully examine the scope of work outlined in the bid package and the proposed drawings, specifications, and forms and shall be thoroughly familiar with all existing conditions and expectations of a successful project completion.

No increase in cost or extension in performance time will be considered for failure to know the conditions to be encountered as to the character, quality, and quantity of the work to be performed, and materials to be furnished, and as to the requirements of the specifications.

No increase in cost or extension in performance time will be considered for material escalation. Section 01027 – Applications for Payment, Part 1, Subpart 1.3, Schedule of Values; B,5 of the contract documents provides a provision for the storage of materials, off-site if necessary, to help in managing the project costs and to hedge against potential future material price increases.

A 5% list showing all Subcontractors to be used on the project shall be submitted with the bid followed by a 1% list within 2 hours from the completion of the bid opening, as required by Nevada Revised Statutes. WCSD also requires a Comprehensive Contractor/Subcontractor list showing all remaining subcontractors to be utilized on the

project. All subcontractors shall be licensed as required by Nevada Revised Statutes.

Any Addendums issued during the bid solicitation process shall be acknowledged on the Bid Form (PUR-F523) and in the execution of a contract, Addendums will become a part thereof.

All questions shall be submitted in writing directly to WCSD's Solicitations website at <http://solicitations.washoeschools.net> or via e-mail to solicitations@washoeschools.net by **4:30 p.m. (Local Time) on May 1, 2025**. During this active solicitation there shall be no personal contact with any WCSD employees or other parties associated with this project directly. All inquiries shall be done in writing as stated above.

Addendums will be distributed by WCSD accordingly and can also be accessed via the WCSD Public Works website at: <http://solicitations.washoeschools.net/>

Modifications to bids may only be considered if submitted bids by delivery as previously noted have already been received and said modifications are completed prior to the due date and time for the bid submission.

Bids may be withdrawn in a written request received from a Contractor prior to the time fixed for opening of bids.

In cases where the award of the project has not been made, bids submitted and opened may not be withdrawn for a period of forty-five (45) calendar days from the due date and time of the bid.

A person who bids on this work may file a notice of protest regarding the awarding of the contract with the WCSD's Purchasing Department's Director of Procurement and Contracts within five (5) business days after the date the recommendation to award a contract is issued. The notice of protest must be submitted in accordance with NRS [Chapter 338.142](#). Detailed specifications can be found in Section 00820 – Special Conditions, subsection 14.0 – Appeal by Unsuccessful Bidder.

A person filing a notice of protest in accordance with NRS [Chapter 338.142](#) will be required to post a bond or other security in the amount of twenty-five (25%) percent of the value of the total bid or two hundred fifty thousand (\$250,000) dollars, whichever is less. If the protest cannot be resolved by the WCSD's Director of Procurement and Contracts, it will be presented to the WCSD Board of Trustees at a regular meeting.

Contractors to be considered as a Preferential Bidder must submit the Certificate of Eligibility for Preferential Status issued by State of Nevada Contractors Board with their bid submission and the Preferential Bidder Status Affidavit must be provided within two (2) hours after the bid opening, although WCSD prefers the affidavit to also be submitted with the bid at the time of opening.

SPECIAL NOTIFICATIONS

Signature Requirements

Any bid submission will be disqualified and rejected if the bid submission is not signed.

Washoe County School District only accepts signatures done manually (also known as a wet signature) or electronic digital signatures that are certified. Non-certified electronic digital signatures will NOT be accepted. A typed signature, even in cursive font, DOES NOT meet the requirements of an official digital signature. A digital signature must be accompanied by a certified digital stamp issued through programs like Adobe Acrobat, Docu-Sign or other similar programs that produce a digital stamp certifying the electronic digital signature. Any signatures on required forms that do not meet these requirements will not be accepted and the Contractor's submission will be deemed "Non-Responsive" and will be rejected. If you have any questions about this requirement, please submit your question by the question deadline, so that it can be answered prior to the bid submission deadline.

Preferential Bidders

Contractors to be considered as a Preferential Bidder must submit the Certificate of Eligibility for Preferential Status issued by State of Nevada Contractors Board with their bid submission and the Preferential Bidder Status Affidavit must be provided within two (2) hours after the bid opening, although WCSD prefers the affidavit to also be submitted with the bid at the time of opening. Preferential Bidder Status shall be considered if the amount of the apparent low bid is \$250,000 or greater per NRS [Chapter 338.1389](#).

Specifications/Addendums

Contractor is responsible to ensure that he/she has received and reviewed the entire bid package, including specifications, plans and any/all issued Addendums. Contractors shall acknowledge by signing any issued Addendum(s) and returning the signed Addendums with his/her bid submission.

Technical Specifications

Any conflicts between the Architect and WCSD specification, it will be the responsibility of the Contractor to seek clarification for any conflicts or be responsible for all the requirements. Clarifications and questions must be submitted in writing via email to: solicitations@washoeschools.net

Washoe County School District Structured Cabling Standard – WCSD-SCS-015

The Washoe County School District Structured Cabling Standard – WCSD-SCS-015 dated March 13, 2023 is located on our website. The link to view it is

<https://www.washoeschools.net/cms/lib/NV01912265/Centricity//Domain/70/ITPC%20Images/WCSD-SCS-015%203-10-23.pdf>

Project Completion

The construction contract time allowed for this project is based on a reasonable expectation of how long it will take to do a project of this scope. WCSD recognizes that Contractors often try to finish projects in significantly less time than the construction contract time and, in such cases, develop schedules which are based on everything going smoothly with no delays. While WCSD allows Contractors to submit such accelerated construction schedules, WCSD reserves the right to deny the Contractor's submission. Acceptance of a submittal with a shortened schedule is not an official agreement between

WCSD and the Contractor that the project can be done in less time than the construction contract time specified.

Roof Penetrations

All roof-mounted equipment or penetrations associated with this project are to be flashed by a licensed roofing Contractor. The roofing Contractor shall have experience with the existing roofing membrane. New flashing materials shall be installed to comply with the membrane manufacturer's specifications or details published by the National Roofing Contractors Association Waterproofing Manual. In acceptance of the work, the Owner will make no allowance for lack of skill on the part of the Contractor. The Contractor shall coordinate all aspects of roof work including any penetrations to maintain the building in a totally watertight condition, no exceptions.

Hours

There is a potential that Summer School, Extended School Year (ESY), Intercession School, After School Care, Parent nights, etc. may be held at the project sites. The Contractor will be required to flex schedule and/or work areas to accommodate school needs during this time frame. In addition, the Contractor may have to alter their normal schedule in order to perform any lead and asbestos attachments and penetrations.

Pre-Bid Meeting Attendance

All Pre-Bid Meetings, whether mandatory or not, will require that all attendees sign in on the sign-in sheet provided. It is the Contractor's responsibility to ensure that he/she documents his/her attendance by signing the Pre-Bid Sign-In Sheet. Failure to do so could result in the Contractor's bid not being accepted by the WCSD, especially in the event of a Mandatory Pre-Bid Meeting.

In addition, if a Pre-Bid Meeting is held on-site, especially a school site, it is the Contractor's responsibility to sign in/register presence on grounds with the site's Front Office. A signature on a school's office sign-in sheet will not take the place of signature on the Pre-Bid Sign-In Sheet, which will only be present at the actual meeting and distributed by the staff of the Purchasing Department and Capital Projects Department.

Questions

All questions shall be submitted in writing directly to WCSD's Solicitations website at <http://solicitations.washoeschools.net/> or via e-mail to solicitations@washoeschools.net by 4:30 p.m. (Local Time) May 1, 2025.

Force Accounts

When applicable, the force account amount listed on the Bid Form (PUR-F523) shall be used for changes in the work at the Owner's discretion. Any changes shall be approved by change order and the force account balance shall be reduced to reflect said change. Any remaining force account balance at the completion of the project shall be returned to the Owner by a deductive change order.

Working Hours

From 7:00 am to 7:00 pm – Monday through Friday the site will be available to the Contractor.

WCSD's Project Management Software (Procore)

The Awarded Contractor will be required to utilize WCSD's Project Management Software (Procore) for workflow of project documents. This will include, but not limited to submissions of RFIs, submittals, schedule and schedule updates, change documents, payment requests, and close out documents. The Awarded Contractor will be required to work with WCSD Project Manager and WCSD Consultants to manage process to meet project schedule needs. See Section 01041 – Project Management Software for details.

KNOW ALL PERSONS BY THESE PRESENTS, that we, the undersigned _____, as Principal, and _____ as Surety, are hereby held and firmly bound unto the Board of Trustees, Washoe County School District, as Owner, in the sum of _____ Dollars (\$_____) for payment of which, well and truly to be made, we hereby jointly and severally bind ourselves, our heirs, executors, administrators, successors, and assigns.

Signed this _____ day of _____, 20_____.

The condition of the above obligation is such that whereas the Principal has submitted to the Board of Trustees, Washoe County School District, a certain bid, attached hereto and hereby made a part hereof, to enter into a Contract in writing for:

_____.

NOW, THEREFORE, if said bid shall be rejected, or in the alternative, if said bid shall be accepted and the Principal shall execute and deliver a Contract in the form of Contract attached hereto (properly completed in accordance with said bid) and shall furnish a Bond for its Faithful Performance of said Contract, and a Bond for the payment of all persons performing labor or furnishing materials in connection therewith, and shall in all other respects perform the contract created by the acceptance of said bid, then this obligation shall be void.

Otherwise, the same shall remain in force and effect, and the sum herein specified paid over to the Owner; it being expressly understood and agreed that the liability of the Surety for any and all claims hereunder shall, in no event, exceed the amount of this obligation as herein stated.

The Surety, for value received, hereby stipulates and agrees that the obligations of said Surety and its bond shall be in no way impaired or affected by an extension of the time within which the Owner may accept such bid; said Surety does hereby waive notice of any such extension.

IN WITNESS WHEREOF, the Principal and the Surety have hereunto set their hands and seals, and such of them as are corporations have caused their corporate seals to be hereto affixed and these presents to be signed by their officers, the day and year first set forth above.

(Seal)

Principal

By: _____

Surety

By: _____

(Seal)

Address:

Phone: _____

SECTION 00500 – SAMPLE CONTRACT (PUR-F532)

THIS CONTRACT, made by and between _____ hereinafter called the Contractor, and **WASHOE COUNTY SCHOOL DISTRICT**, hereinafter called the Owner,

WITNESSETH, that the Contractor and the Owner, for the consideration hereinafter named, agree as follows:

Article 1 – Scope of Work. The Contractor shall furnish all of the materials and perform all of the work in conformance with the Contract Documents entitled _____ **(Bid # _____)**.

Article 2 – Time of Completion. The work to be performed under this Contract shall be commenced on the date set forth in the Notice to Proceed and shall be completed on or before _____ **or in _____ calendar days.** The Contractor agrees that Owner may retain from the monies due the Contractor the actual value of the damages to the Owner as a direct result of the Contractor’s delay or for not completing the project in the required time allowance plus approved time extensions.

Article 3 – The Contract Sum. The Owner shall pay the Contractor for the performance of the Contract, subject to additions and deductions provided therein, in current funds the following stipulated sum:
_____ **(\$ _____)**.

Article 4 – Progress Payments. The Owner shall make payments and pay interest to the Contractor in accordance with Nevada Revised Statutes, Chapter 338. No monies payable under this Contract shall be assigned by Power of Attorney, or otherwise, except upon written consent of Owner.

Article 5 – Acceptance and Final Payment. Upon written notice to the Owner that the work is one hundred percent (100%) complete, the Owner shall inspect the project. When the project is one hundred percent (100%) acceptable and complete to the Owner, the Contractor shall submit evidence satisfactory to the Owner that all payrolls, material bills, interest on retention, and other indebtedness connected with the work have been paid. Once all requirements have been satisfied, the Owner shall issue a fully executed Certificate of Completion which shall constitute the Owner’s acceptance of the work in accordance with NRS [Chapter 338](#).

Article 6 – The Contract Documents. The entire bidding documents, including but not limited to the: Notice to Contractors, Instructions to Bidders, Contractor’s Bid, General Conditions, Supplementary Conditions, Special Conditions, Technical Specifications, Addenda, and the Drawings (if any), and this document form the Contract, and they are as fully a part of the Contract as if hereto attached.

Article 7 – Lead and Asbestos Certification. The Contractor hereby certifies that no lead/asbestos containing building material will be used for the construction of the project. If a lead/asbestos containing building material is subsequently found to have been included in the construction of the project, the Contractor shall be responsible for and indemnify the Owner against all costs for the proper removal of the lead/asbestos containing building material and the replacement of said material with a non-lead/asbestos containing material substitute. The removal method shall be specifically approved by the Owner and any and all authorities having jurisdiction over such removal.

IN WITNESS WHEREOF, the parties hereto have executed this Contract the day and year written below.

Bid # _____ - _____

WASHOE COUNTY SCHOOL DISTRICT

CONTRACTOR

Signature

Signature

Name

Name

Title

Title

Date

Date

SECTION 00600 – SAMPLE LABOR AND MATERIALS BOND (PUR-F526)

KNOW ALL PERSONS BY THESE PRESENTS: That WHEREAS, the Board of Trustees of Washoe County School District in the State of Nevada has awarded to _____, hereinafter designated as “Principal”, a contract dated _____, for _____

_____ a copy of which contract is attached hereto and by reference made a part hereof, and hereinafter referred to as the “Contract.”

And WHEREAS, said Principal is required under the terms of said Contract and by law under the provisions of [NRS Chapter 339](#) to furnish a Bond for the Labor and Materials used in said Contract;

NOW, THEREFORE, we, the Principal, and _____, as Surety, are held and firmly bound unto the Board of Trustees of Washoe County School District in the State of Nevada in the sum of _____ Dollars (\$_____), lawful money of the United States, being not less than one hundred percent (100%) of the estimated Contract cost of the work, for the payment of which sum will and truly to be made, we bind ourselves, our heirs, executors, administrators, and successors, jointly and severally, firmly by these presents.

THE CONDITION OF THIS OBLIGATION IS SUCH, that if the above-bounden Principal, or its heirs, executors, administrators, successors or assigns shall fail to pay for any materials, provisions, supplies implements or machinery used in, upon, for, or about the performance of the work contracted to be done, or for any work or labor thereon of any kind, or for amounts due under the Unemployment Compensation Law with respect to such work or labor, as required by the Provisions of [NRS Chapter 339](#), the Surety hereon will pay for the same within thirty (30) calendar days an amount not exceeding the sum specified in this bond, and the above obligation shall then be null and void. Otherwise, it shall remain in full force and virtue.

THE SURETY, for value received, hereby stipulates and agrees that no change, extension of time, alteration or addition to the terms of the Contract, or to the work to be performed thereunder, or to the specifications accompanying the same, shall in any way affect its obligations on this bond, and it does hereby waive notice of any such change, extension of time, alteration or addition to the terms of the Contract or to the work, or to the specifications.

And the said Surety, for value received, further stipulates and agrees that should the Board of Trustees of Washoe County School District, or other obligees, incur attorney's fees or other expenses for the enforcement of the Contract or this bond, the same shall

be paid by the Surety to the contracting body, subcontractors, workmen laborers, mechanics and furnishers of material as their interests may appear.

IN WITNESS WHEREOF, the above-bounded parties have executed this instrument under their seals this _____ day of _____, 20____, the name and corporate seal of each corporate party being hereto affixed and these presents duly signed by its undersigned representative, pursuant to authority of its governing body.

Principal

(Seal)

By: _____

Surety

By: _____

(Seal)

Address:

Phone: _____

SECTION 00610 – SAMPLE PERFORMANCE BOND (PUR-F527)

KNOW ALL PERSONS BY THESE PRESENTS: That WHEREAS, the Board of Trustees of Washoe County School District in the State of Nevada has awarded to _____, hereinafter designated as “Principal”: a contract dated _____, for _____

_____ a copy of which contract is attached hereto and by reference made a part hereof, and hereinafter referred to as the “Contract”.

And WHEREAS, said Principal is required under the terms of said Contract and by law under the provisions of [NRS Chapter 339](#) to furnish a Bond for the faithful Performance of said Contract;

NOW, THEREFORE, we, the Principal, and _____, as Surety, are held and firmly bound unto the Board of Trustees of Washoe County School District in the State of Nevada in the sum of _____ Dollars (\$_____), lawful money of the United States, being no less than one hundred per cent (100%) of the estimated Contract Cost of the work, for the payment of which sum well and truly to be made, we bind ourselves, our heirs, executors, administrators, and successors, jointly and severally, firmly by these presents.

THE CONDITION OF THIS OBLIGATION IS SUCH, that if the above bounden Principal, or its heirs, executors, administrators, successors, or assigns, shall in all things stand to and abide by and well and truly keep the faithfully perform the covenants, conditions, and agreements in the Contract and any alterations made as therein provided, on his or its part to be kept and performed at the respects according to their true intent and meaning; and shall indemnify and save harmless the Board of Trustees of Washoe County School District in the State of Nevada, its officers and agents, as therein stipulated; then this obligation shall become null and void. Otherwise, it shall be and remain in full force and virtue.

As a condition precedent to the satisfactory completion of the Contract, the above obligation shall hold good for a period of one (1) year after completion and acceptance of the work done, during which time if the above-bounden Principal, his or its heirs, executors, administrators, successors, or assigns shall fail to make full, complete, and satisfactory repair and replacements or totally protect the Board of Trustees of Washoe County School District in the State of Nevada from loss or damage made evident during said period of one (1) year from the date of acceptance of said work, and resulting from or caused by defective materials or faulty workmanship in the prosecution of the

work done, the above obligation in the said sum of _____ Dollars (\$_____) shall remain in full force and virtue; otherwise, the above obligation shall be void.

THE SURETY, for value received, hereby stipulates and agrees that no change, extension of time, alteration or addition to the terms of the Contract, or to the work to be performed thereunder, or to the specifications accompanying the same, shall in anyway affect its obligations on this bond, and it does hereby waive notice of any such change, extension of time, alteration or addition to the terms of the Contract, or to the work, or to the specifications.

And the said Surety, for value received, further stipulates and agrees that should the Board of Trustees, Washoe County School District, incur attorney's fees or other expenses for the enforcement of the Contract or his/her bond, the same shall be paid by the Surety to the Board of Trustees, Washoe County School District.

IN WITNESS WHEREOF, the above-bounden parties have executed this instrument under their seals this _____ day of _____, 20____, the name and corporate seal of each corporate party being hereto affixed and these presents duly signed by its undersigned representative, pursuant to authority of its governing body.

Principal

(Seal)

By: _____

Surety

(Seal)

By: _____

Address:

Phone: _____

SECTION 00700 – GENERAL CONDITIONS

The General Conditions of the Contract for Construction, AIA Document A201, 2017 Edition, Articles 1 through 15, are hereby incorporated by reference as the “General Conditions of this Project.” Copies of General Conditions may be examined or obtained through formal request to the WCSD’s Purchasing Department located at the Brown Center, 14101 Old Virginia Road, Room 0, Reno, Nevada, 89521 or by phone at (775) 850-8025.

The information contained in the Supplementary General Conditions (Section 00800), Special Conditions (Section 00820), Instructions to Bidders (Section 00100), and the Bid Form (PUR-F523) shall become a part of the Contract and shall apply to all Contractors and Subcontractors. The information contained in Supplementary General Conditions (Section 00800) may amend, modify, supersede, void or supplement the Articles of the “General Conditions of the Project.” Where any part of an Article of the “General Conditions of the Project” is amended, modified, superseded or voided by a provision of the Supplementary General Conditions (Section 00800) or other Contract documents, all other provisions of such Article shall remain in effect, and the provisions of the Supplementary General Conditions (Section 00800) or other Contract documents shall be considered as added.

SECTION 00800 – SUPPLEMENTARY GENERAL CONDITIONS

The General Conditions of the Contract for Construction, AIA Document A201, 2017 Edition, Articles 1 through 15, are hereby incorporated by reference as the “General Conditions of this Project.” Copies of General Conditions may be examined or obtained through formal request to the WCSD’s Purchasing Department located at The Brown Center, 14101 Old Virginia Road, Room 0, Reno, Nevada, 89521 or by phone at (775) 850-8025.

The information contained in the Supplementary General Conditions (Section 00800), Special Conditions (Section 00820), Instructions to Bidders (Section 00100), and the Bid Form (PUR-F523) shall become a part of the Contract and shall apply to all Contractors and Subcontractors.

In any instance where no Architect is involved in the project, any and all references contained in this or any other documents to "Architect" shall be deemed to refer to the consulting Engineer, if any, the special project consultant, if any, or, in the event no such individuals are involved, to the Owner.

The following supplements modify, delete and/or add to the “General Conditions of the Project.” Where any Article, Paragraph or Subparagraph in the “General Conditions of the Project” is supplemented by one of the following Paragraphs, the provisions of such Article, Paragraph, or Subparagraph shall remain in effect and the supplemental provisions shall be considered as added. Where any Article, Paragraph, or Subparagraph in the “General Conditions of the Project” is amended, voided or superseded by any of the following paragraphs, the remaining provisions of such Article, Paragraph or Subparagraph not amended, voided, or superseded shall remain in effect.

1. LIABILITY INSURANCE SPECIFICATIONS

A. INTRODUCTION

The Owner has established specific indemnification and insurance requirements for its construction contracts to help assure that reasonable insurance coverage is purchased and maintained. Insurance, indemnification and hold harmless clauses are intended to assure that a Contractor accepts and is able to pay for the loss or liability related to its activities.

Contractor’s attention is directed to the insurance requirements below. It is recommended that Contractors confer with their respective insurance carriers or brokers to determine **in advance of Bid submission** the availability of insurance certificates and endorsements as described and provided herein.

B. INDEMNIFICATION AGREEMENT

The Contractor agrees to hold harmless, indemnify and defend the Owner, its officers, agents, employees and volunteers from any loss or liability, financial or otherwise resulting from any claim, demand, suit, action, or cause of action based on bodily injury, including death, or property damage, including damage to the

Contractor's property or injury to the Contractor's employees, caused by any action, either direct or passive, the omission, failure to act or negligence on the part of the Contractor, employees, agents, representatives or Subcontractors arising out of the performance of work under this Contract by the Contractor, or by others under the direction or supervision of the Contractor.

In determining the nature of the claim against the Owner, the incident underlying the claim shall determine the nature of the claim, notwithstanding the form of the allegations against the Owner.

In the event of a lawsuit against the Owner, its officers, agents, employees and volunteers, the Contractor shall reimburse the Owner for costs of the Owner's attorneys' fees and costs, as well as personnel in defending such actions. Reimbursement for the time spent by such personnel shall be at the rate charged for such services by private counsel. The Owner shall not be held liable for any accident, loss or damage to the work prior to its completion and acceptance.

C. GENERAL REQUIREMENTS

The Contractor shall purchase Workers Compensation Insurance, General Liability and Automobile Liability as described below. The cost of such insurance shall be included in the Contractor's bid price.

D. WORKERS COMPENSATION INSURANCE

It is understood and agreed that there shall be no Workers Compensation Insurance coverage provided for the Contractor or any Subcontractor by the Owner. Contractor agrees, as a precondition to the performance of any work under this Contract and a precondition to any obligation of the Owner to make any payment under this Contract, to provide Owner with certificates issued by an insurer that shows compliance with NRS [Chapters 616A, 616B, 616C](#) and [616D](#), inclusive, and [Chapter 617](#).

It is further understood and agreed by and between the Owner and the Contractor that the Contractor shall procure, pay for, and maintain the above-mentioned Workers Compensation Insurance coverage at the Contractor's sole cost and expense.

Should Contractor be self-funded for Workers Compensation Insurance, Contractor shall notify Owner in writing prior to the acceptance of this Contract. Owner reserves the right to approve said retentions and may request additional documentation, financial or otherwise, for review prior to the acceptance of this Contract as provisioned under NRS [Chapter 616B.627](#).

E. MINIMUM SCOPE OF LIABILITY INSURANCE

Coverage shall be at least as broad as:

1. Insurance Services Office (ISO) Commercial General Liability Coverage "Occurrence" form CG 0001 12 04 or substitute form

providing coverage as broad as CG 0001 12 04. The Commercial General Liability Coverage shall include, but is not limited to, Liability Coverage arising from Operations, Premises, Blanket Contractual Liability, Broad Form Property Damage Liability, Products and Completed Operations, Personal Injury and Advertising Liability, and Stop Gap or Employers Liability. In addition, explosion, collapse, and underground coverage must be included unless Owner waives this requirement in writing prior to execution of Contract.

2. Business Auto Coverage form number ISO CA 0001, CA 00 055, CA00 12, CA 00 20 or an equivalent form covering Automobile Liability Symbol 1 "Any Auto."

F. MINIMUM LIMITS OF INSURANCE

The Contractor shall maintain limits no less than:

1. General Liability: **\$1,000,000** minimum or the amount customarily carried by the Contractor, whichever is greater, combined single limit per occurrence (with \$2,000,000 Aggregate Limit) for bodily injury, personal injury, and property damage. General Liability coverage shall specifically apply to the acts and/or omissions of Contractor and his/her Subcontractors. The above General Liability coverage shall be maintained in full force and effect for five (5) years from the date of completion of the project. The required limits may be met through a combination of primary and excess liability coverage. Any excess liability coverage shall provide coverage at least as broad as the primary coverage and be subject to all of the requirements herein.
2. Automobile Liability: \$1,000,000 minimum or the amount customarily carried by the Contractor, whichever is greater, combined single limit per accident for bodily injury and property damage. No Aggregate Limits may apply. Non-owned and hired automobile liability must be included.
3. Workers Compensation Insurance: \$1,000,000 minimum in limits (Employers Liability) and obtain Statutory Limits of Workers Compensation Insurance for employees engaged on or at the site of the project in accordance with NRS [Chapters 616A](#), [616B](#), [616C](#) and [616D](#), inclusive, and [Chapter 617](#). If an excess policy is utilized, the policy will provide excess coverage for Employers' Liability.
4. Asbestos Environmental Risk Liability Insurance: Not Required for This Project

G. ASBESTOS COVERAGE

Not Required for This Project.

H. PROPERTY COVERAGES

Not Required for This Project.

I. DEDUCTIBLES AND SELF-INSURED RETENTIONS

Any deductibles or self-insured retention must be declared to and approved by the Owner. The Owner reserves the right to request additional documentation, financial or otherwise, prior to giving its approval of the deductibles and self-insured retention's and prior to executing the Contract. Any changes to the deductibles or self-insured retentions made during the term of this Contract or during the term of any policy, must be approved by the Owner prior to the change taking effect. It is also understood that the Contractor is responsible for and shall assume payment of all deductibles and/or self-insured retentions.

J. OTHER INSURANCE PROVISIONS

The policies are to contain, or be endorsed to contain, the following provisions:

1. General Liability and Automobile Liability Coverages

- a. The Owner, its agents, officers, employees and volunteers are to be included as Additional Insureds for damages and defense arising from: activities performed by or on behalf of the Contractor, including the insured's general supervision of the Contractor; products and completed operations of the Contractor; premises owned, occupied or used by the Contractor; or automobiles owned, leased, hired or borrowed by the Contractor. The coverage shall contain no special limitations on the scope of protection afforded to the Owner, its officers, employees or volunteers.
- b. The Contractor's insurance coverage shall be primary insurance with respect to the Owner, its officers, employees and volunteers. Any insurance or self-insurance maintained by the Owner, its officers, employees or volunteers shall be in excess of the Contractor's insurance and shall not contribute to the Contractor's insurance coverage in any way.
- c. The Contractor's insurance shall apply separately to each insured against whom claim is made or suit is brought, except with respect to the limits of the insurer's liability.
- d. The insurance companies issuing the policy or policies shall have no recourse against the Owner payment of any premiums, costs or assessments under any form of policy.
- e. Failure of the Contractor to take out and/or maintain any required insurance shall not relieve the Contractor from any liabilities under this Contract, nor shall the insurance

requirements be construed to conflict with or otherwise limit the obligations of the Contractor concerning indemnification.

2. All Coverages

- a. Each insurance policy required by this clause shall be endorsed to state that coverage shall not be suspended, voided, canceled or non-renewed by either the Contractor or by the insurer, reduced in coverage or in limits except after thirty (30) days prior written notice has been given to the Owner, which must be approved, if acceptable, by the Owner in writing.

Furthermore, Contractor shall provide the Owner thirty (30) days prior notice, in writing when the Contractor elects to change carriers, not to renew the policy, or reduce coverage, which must be approved, if acceptable, by the Owner also in writing.

- b. The Contractor's insurers shall have no right of recovery or subrogation against the Owner or the design professionals which provide work on the project.
- c. Any failure to comply with reporting provisions of the policies shall not affect coverage provided to the Owner, its officers, employees or volunteers.
- d. The insurance companies issuing the policy or policies shall have no recourse against the Owner for payment of any premiums, costs or assessments under any form of policy.

K. ACCEPTABILITY OF INSURERS

Insurance is to be placed with insurers with an A.M. Best's rating of no less than A:X. The Owner may accept coverage with carriers that have lower A.M. Best's ratings upon review of financial information concerning Contractor and insurance carrier. The Owner reserves the right to require that the Contractor's insurer(s) be a licensed and admitted insurer(s) in the State of Nevada, or on the Insurance Commissioner's approved, but not admitted, list.

L. VERIFICATION OF COVERAGE

Prior to the commencement of any work on the project, the Contractor shall furnish the Owner with certificates of insurance and with original endorsements affecting coverage required. The certificates and endorsements for each insurance policy are to be signed by a person authorized by that insurer to bind coverage on its behalf. All certificates and endorsements are to be received and approved by the Owner before work commences. The Owner reserves the right to require complete, certified copies of all required insurance policies, at any time should it be deemed in the best interest of the Owner.

M. SUBCONTRACTORS

The Contractor shall include all Subcontractors as insureds under its policies or shall furnish separate certificates and endorsements for each Subcontractor. All coverages for Subcontractors shall be subject to all of the requirements stated herein, except that if any Subcontractors maintain limits of insurance less than required in this Contract, Contractor's insurance shall include coverage for acts or omissions of Subcontractor up to the full limits required in this Contract.

N. MISCELLANEOUS CONDITIONS

1. The Contractor shall be responsible for and remedy all damage or loss to any property, including property of the Owner, caused in whole or in part by the Contractor, any Subcontractor, or any employed, directed or supervised by the Contractor.
2. Nothing herein contained shall be construed as limiting in any way the extent to which the Contractor may be held responsible for payment of damages to persons or property resulting from its operations or the operations of any Subcontractor under it.
3. In addition to any other remedies the Owner may have should the Contractor fail to provide or maintain any insurance policies or policy endorsements to the extent and within the time required, the Owner may, at its sole option:
 - a. Purchase such insurance to cover any risk for which the Owner may be liable through the operations of the Contractor under this Contract and deduct or retain the amount of the premiums for such insurance from any sums due to the Contractor under the Contract; or
 - b. Order the Contractor to cease work under this Contract and/or withhold any payments, which became due the Contractor until the Contractor demonstrates compliance with the requirements hereof; or
 - c. Terminate the Contract.

2. **GUARANTEE BOND**

Not Required for This Project.

3. **INTEREST**

Article 13.5 is hereby supplemented as follows:

Not Required for This Project.

4. CLEANING UP

Article 3.15 is hereby supplemented as follows:

The Contractor, at all times, shall keep the premises free from accumulation of waste materials or rubbish caused by operations. At the completion of the work, Contractor shall remove all waste materials and rubbish from and about the project as well as all tools, construction equipment, machinery and surplus materials, and shall clean all glass surfaces and leave the work "broom clean" or its equivalent, except as otherwise specified.

5. LIQUIDATED DAMAGES

Add Article 8.2.4 as follows:

It is hereby understood and mutually agreed that the date of beginning, rate of progress, and the time for completion of the work to be done hereunder are essential conditions of this Contract and that the work embraced in this Contract shall be commenced on the date set forth in the Notice to Proceed issued by the Owner.

The Contractor agrees that all work shall be performed regularly, diligently, and uninterruptedly at a rate of progress that will ensure substantial completion within the time specified. It is expressly understood and agreed, by and between the Contractor and the Owner, that the time for completion of the work described herein is an acceptable time for the completion of the work. If the Contractor should neglect, fail, or refuse to complete the work within the specified Contract time, that has been extended by the Owner, then the Contractor does hereby agree, as a part of the consideration for receiving the award of this Contract, to pay to the Owner, not as a penalty, but as Liquidated Damages, the amount of money specified in the Contract (Section 00100 – Instruction to Bidders and Bid Form (PUR-F523) per day. If the Owner incurs costs in excess of the Liquidated Damages as a result of the Contractor's inability to complete the work by the specified date the additional cost will be deducted from the Contract amount.

If the Contractor fails to complete or correct the work listed on the comprehensive list of deficiencies ("**Punch-List**") within the specified time for performance, the Contractor does hereby agree to pay the Owner **\$500** as Liquidated Damages for each calendar day that the completion or correction of the work extends beyond the 45 days for performance allowed from the date the Contractor receives the Punch List of deficiencies from the Architect and/or his/her consultants and/or the Owner.

6. CHANGE ORDERS

Article 7.2 is hereby modified as follows:

A. The Owner, without invalidating the contract, may order changes in the work consisting of additions, deletions, or other revisions, the contract sum and contract time being adjusted accordingly. All such changes in the work shall be authorized by Change Order issued by the Owner.

B. The cost or credit to the Owner resulting from a change in the work shall be determined by the Architect in one or more of the following ways:

1. By unit prices stated in the Contract documents or subsequently agreed upon.
2. By mutual acceptance of a lump sum proposal, properly itemized by contractor/subcontractor, to include the following:
 - a. Labor, including fringe benefits, payroll taxes, and workers' compensation insurance;
 - b. Materials entering permanently into the work;
 - c. Equipment costs for equipment utilized to perform the Change Order work; and/or
 - d. Change Order Mark-Up per Schedule.
3. By the actual cost of properly itemized by contractor/subcontractor, to include the following:
 - a. Labor, including fringe benefits, payroll taxes, and workers' compensation insurance;
 - b. Materials entering permanently into the work;
 - c. Equipment costs for equipment utilized to perform the Change Order work; and/or
 - d. Change Order Mark-Up per Schedule.

C. The costs under Paragraph 6(B) 1-3 above may be increased by General/Prime Contractor, Subcontractor (all tiers) to include a fixed fee for Subcontractor profit and overhead, Prime Contractor profit and overhead on Subcontractor work, and profit and overhead on work done by the General/Prime Contractor's own forces. The total of such fixed fee shall not exceed the amount determined from the Change Order Mark-Up Schedule below for a single Change Order item, or for any group of related items, and shall be full compensation for the cost of supervision (to include Project Manager, Project Coordinator, Superintendent, Administrative Staff, etc.), overhead, profit, insurance, general conditions not listed and any BIM updating, Procore updating, or other general expense associated with completing the change in the scope of work. The allowable mark-up fee for contractor bonding shall be in addition to the fee below for the Prime Contractor only and shall not exceed 1% of the change if applicable.

CHANGE ORDER MARK-UP SCHEDULE

1. Additive Changes (for the entity performing the work):	
<u>Total Cost of Change</u> +\$0.01 to +\$50,000 +\$50,000.00 and above	<u>Allowable Fee</u> 15% of the Total Cost 10% of the Total Cost
2. Additive Changes (Contractor Markup) Subcontractors work:	
<u>Total Cost of Change</u> +\$0.01 to +\$50,000 +\$50,000.00 and above	<u>Allowable Fee</u> 10% of the Total Subcontractor Fee 5% of the Total Subcontractor Fee
3. Deductive Changes:	
<u>Total Credit Cost of Change</u> +\$0.01 to +\$50,000 +\$50,000.00 and above	<u>Credit Fee to be Applied</u> 10% of the Total Subcontractor Cost. (Deductive) 5% of the Total Subcontractor Fee (Deductive)
<i>Example of Deductive Change: Assume <\$5,000.00> to be credited. The Contractor must include a 10% credit for profit and overhead, i.e. \$5,000.00 X 0.10 = <\$5,500.00> total credit to the Contract.</i>	

D. No fees shall be paid for time extensions.

E. All proposals shall be submitted to the Architect in sufficient detail to complete an analysis of all costs. The Contractor shall submit invoices for materials and equipment utilized in Change Order work. Labor rates shall not exceed the applicable Wage Rates (including Prevailing Wage Rates) as published by the State of Nevada Office of the Labor Commissioner. Fringe benefits shall not exceed the cost of fringe benefits normally paid to such personnel or established by the industry in the Northern Nevada area, whichever is lower. Labor rates or additional rates not identified as part of Prevailing Wage Rates shall be identified and approved by WCSD prior to start of construction.

7. SUBCONTRACTORS

Article 5.2.1 is hereby modified as follows:

A. Per NRS [Chapter 338](#):

1. Except as otherwise provided in Subsection 2, each bid submitted to any officer, department, board or commission for the construction of any public work or improvement must include:
 - a. The name of each Subcontractor who will provide labor or a portion of the work or improvement to the Contractor for which he/she will be paid; and

- b. A description of the portion of the work or improvement which each Subcontractor named in the bid will complete.
2. The Contractor shall list in the Bid Form (PUR-F523) pursuant to Subsection 1 the name of a Subcontractor for each portion of the project that will be completed by him/her.
3. A Contractor whose bid is accepted, shall not substitute any person for a Subcontractor who is named on the Bid Form (PUR-523), unless:
 - a. The Owner objects to the Subcontractor, requests in writing a change in the Subcontractor and pays any increase in costs resulting from the change; or
 - b. The substitution is approved by the Owner and:
 1. The Subcontractor, after having a reasonable opportunity, fails or refuses to execute a written contract with the Contractor, which was offered to the Subcontractor with the same terms and conditions that all other Subcontractors on the project were offered; or
 2. The named Subcontractor files for bankruptcy or becomes insolvent; or
 3. The named Subcontractor fails or refuses to perform subcontract within a reasonable time.

8. MANDATORY DRUG TESTING PROGRAM

- A. In order to be eligible to perform work on WCSD construction projects all Contractors who will work on such projects must have a current and valid Drug and Alcohol Policy that is applicable to all workers who will be employed on those projects regardless of tier. This requirement is a reasonable precaution to ensure a safe and drug-free environment on school construction projects that may involve workers being in relatively in close contact with students.
- B. The Policy must meet the minimum requirements as outlined in Exhibit 1. Each Contractor shall demonstrate compliance with this provision by signature on the Bid Form that the Policy is in place, that it will be actively enforced, and that all workers who will be employed on WCSD projects will have undergone the pre-placement drug testing required by WCSD. The WCSD and/or the Prime Contractor is empowered to review Contractor records of enforcement of its Drug and Alcohol Policy at any time during the construction period up to and including completion of the project in order to determine whether the policy is in fact being enforced. The Contractor shall forthwith deliver to the WCSD any and all records requested to determine compliance with this Drug and Alcohol Policy requirement. Failure to maintain or rigorously enforce the policy or to timely respond to WCSD demands for production of records relating to the Drug and Alcohol Policy may

result in termination of the project agreement at no cost to the WCSD.

- C. Refer to Washoe County School District Mandatory Drug and Testing Program Requirements – EXHIBIT 1.

EXHIBIT 1

WASHOE COUNTY SCHOOL DISTRICT

MANDATORY DRUG AND ALCOHOL TESTING PROGRAM REQUIREMENTS

In order to be eligible to perform work on WCSD construction projects, all Contractors who work on such projects must have a current and valid Drug and Alcohol Policy that meets the following minimum requirements:

1. A statement identifying prohibited conduct regarding employee drug and alcohol use. At a minimum, the policy should address the following areas of prohibited conduct:

- a. Alcohol

Possession of open containers use or being under the influence of alcohol by any employee during normal business hours including lunch breaks, while performing Contractor business, while operating Contractor vehicles or equipment or while on company premises is prohibited. Failure to pass an alcohol test will be grounds for disciplinary action up to and including termination.

- b. Illegal Drugs

The unlawful manufacture, distribution, dispensation, possession or use of a controlled substance is prohibited. Failure to pass a drug test will be grounds for disciplinary action up to and including termination.

- c. Legal Drugs

Except as provided below, use or being under the influence of any mood-altering legal drug by any employee while on company premises or while performing company business is prohibited to the extent such use or influence may affect the safety of the employee, co-workers or the public, the employee's job performance or the safe or efficient operation of the Contractor.

An employee under the influence of a mood-altering legal drug has an obligation to inquire and determine whether the mood-altering legal drug he/she is taking may or will affect his/her ability to safely and efficiently perform his/her job duties. If the employee is using a mood-altering legal drug at the direction of a physician, dentist or other licensed practitioner, the employee is required to inform a designated company official. In compliance with the Americans with Disabilities Act (ADA), this policy does not require the employee, physician, dentist or other licensed practitioner to identify the name of the prescription drug or the medical condition for who it is prescribed. For the safety of all employees, the Contractor

may place persons using such drugs in a less hazardous job assignment or place them on temporary medical leave until released as fit for duty by the prescribing physician, dentist or other licensed practitioner. An employee taking over-the-counter medications contrary to instructions provided by the manufacturer may be subject to disciplinary action up to and including termination.

d. Drug Paraphernalia

Employee possession of drug paraphernalia on the project site is strictly prohibited.

2. A statement requiring, at a minimum, the following types of drug and/or alcohol testing:

a. Pre-Placement Testing

Prior to the start of employment generally, or employment on any WCSD project, the Contractor must assure that any employee assigned to work on a WCSD project has previously completed a pre-placement drug test before the effective date of the project assignment. In the case of a newly hired employee, he/she must pass a pre-placement drug test prior to being allowed to work on a WCSD project.

b. Reasonable Suspicion Testing

Contractor will require a medical examination, breath test, blood test, and/or urinalysis when there is reasonable suspicion to believe that the employee is using drugs and/or alcohol at work or where circumstances or workplace conditions justify it.

c. Post-Accident Testing

Each employee will be tested for prohibited drugs and alcohol use as soon as possible after a reportable accident. Reportable accident is defined as any incident that results in an employee requiring medical treatment that results in the filing of a Workers Compensation claim, or property damage in excess of five hundred dollars (\$500.00). An employee shall not be relieved of duty pending the receipt of test results except where there is reasonable evidence that alcohol or illegal drug use was a contributing factor as determined by the treating physician.

d. Return To Duty Testing and Follow-Up Testing

At the Contractor's discretion, employees in violation of the drug and alcohol policy will be subject to a return to duty policy as a condition of continued employment. In essence, this policy states that the Contractor may rehire or retain the employee in return for the employee's promise to remain alcohol and drug free on WCSD project sites, complete an evaluation by a licensed alcohol and drug counselor and follow all professional recommendations, provide a negative drug and/or alcohol test to return to duty and submit to follow-up testing on a random basis to confirm on-going policy compliance. This document will be

kept in a confidential file belonging to the Contractor's agency.

3. A statement describing the procedures the Contractor will use to test for the presence of alcohol and controlled substances, protect the integrity of the testing processes, safeguard the validity of the test results and ensure that those results are attributed to the correct employee. To meet this requirement, the Contractor is encouraged to follow the Federal Substance Abuse and Mental Health Services Administration (SAMHSA) Drug and Alcohol Testing Guidelines (49 CFR Part 40). At a minimum, the employer must test for the following drugs of abuse:
 - Marijuana
 - Cocaine
 - Opiates
 - Amphetamines/Methamphetamines
 - Phencyclidine (PCP)
 - a. For the purpose of this policy, a positive drug test means that the employee has ingested a drug(s), which causes the employee's drug threshold level to be above the Federal Substance Abuse and Mental Health Services Administration (SAMHSA) Drug and Alcohol Testing Guidelines (49 CFR Part 40). For the purpose of this policy an employee whose breath/blood alcohol level is .04 or greater is considered to be in violation of the policy. It is recommended that blood alcohol testing only be used when an employee is medically unable to provide a breath alcohol sample.
4. A statement indicating the consequences for employees found to be in violation of the drug and alcohol policy. The Contractor's policy must outline the procedures the Contractor will follow to assure that the employee is fit to return to duty following a policy violation. At a minimum, an employee in violation of the Contractor's drug and alcohol policy must complete an evaluation by a licensed alcohol and drug counselor and follow all professional recommendations, provide a negative drug and/or alcohol test to return to duty and submit to follow-up testing on a random basis to confirm on-going policy compliance.
5. A statement indicating that actions taken under this policy will be confidential within the affected Contractor and employee. At a minimum, the Contractor must inform the employee that test results may be disclosed to another member of management on a need-to-know basis and to the employee upon request. Disclosures, without employee consent may also occur when: (A) the information is compelled by law or judicial or administrative process; (B) the information has been placed at issue in a formal dispute between the employer and the employee or job applicant; (C) the information is used in administering an employee benefit plan or other insurance program; (D) the information is needed by first-aid, safety, or medical personnel for the diagnosis or treatment of an employee who is unable/unwilling to authorize disclosure; (E) for review by the State Worker's Compensation Board or the State Unemployment Security Division in determining a pending claim; or (F) the information is compelled by federal officials investigating compliance with the Americans with Disabilities Act (ADA).

6. A statement indicating that all employees shall participate in a company-sponsored drug/alcohol awareness program. The program shall provide employees with information regarding: (A) the company's drug/alcohol free workplace policy; (B) available counseling, referral agencies and rehabilitation; and (C) the penalties imposed upon employees for violations of this policy.

Each Contractor shall ensure that all supervisors designated to supervise employees on a WCSD project complete a training course on reasonable suspicion testing. This training shall include information on the physical, behavioral, speech and performance indicators of probable employee alcohol or drug abuse and how to effectively intervene per Contractor policy.

7. A statement indicating that Subcontractors, Sub-tiered Contractors, vendors, and their employees shall be required to cooperate with the Contractor's policy to achieve a drug/alcohol free workplace.

END OF EXHIBIT 1

9. ARTICLE 1.1 GENERAL PROVISIONS

Add the following at the end of Subparagraph 1.1.1:

In the event of any conflict among the Contract documents, the documents shall be construed according to the following priorities:

- Highest Priority: Modifications
- Second Priority: Agreement
- Third Priority: Addenda—later date to take precedence
- Fourth Priority: Supplementary General Conditions
- Fifth Priority: General Conditions
- Sixth Priority: Specifications with respect to quality and general performance of the Work
- Seventh Priority: Drawings with respect to quantity of materials and general location of the Work. Detail drawings shall take precedence over small scale drawings.

Add the following at the end of Subparagraph 1.2.1:

All Work mentioned or indicated in the Contract documents shall be performed by the Contractor as part of this Contract unless it is specifically indicated in the Contract documents that such Work is to be done by others. Should the Drawings or the Specifications disagree in themselves or with each other, the Contractor shall provide the better quality or greater quantity of work unless otherwise directed by written addendum to the Contractor.

Add the following to Subparagraph 1.2.2:

The Contractor and all Subcontractors shall refer to all of the Drawings, including those showing primarily the Work of the mechanical, electrical and other specialized trades, and to all of the Sections of the Specifications, and shall perform all Work reasonably inferable therefrom as being necessary to produce the indicated results.

Add new Subparagraphs 1.2.4 through 1.2.11 as follows:

- 1.2.4 All indications or notations which apply to one of a number of similar situations, materials or processes shall be deemed to apply to all such situations, materials or processes wherever they appear in the Work, except where a contrary result is clearly indicated by the Contract documents.
- 1.2.5 Where codes, standards, requirements and publications of public and private bodies are referred to in the Specifications, references shall be understood to be to the latest adopted version used to issue permits, except where otherwise indicated.
- 1.2.6 Where no explicit quality or standards for materials or workmanship are established for Work, such Work is to be of good quality for the intended use and consistent with the quality of the surrounding Work and of the construction of the Project generally.
- 1.2.7 All manufactured articles, materials, and equipment shall be applied, installed, connected, erected, used, cleaned, and conditioned in accordance with the manufacturer's written or printed directions and instructions unless otherwise indicated in the Contract documents.
- 1.2.8 The Mechanical, Electrical and Fire Protection Drawings are diagrammatic only, and are not intended to precisely show the alignment, physical locations or configurations of such Work. Such Work shall be installed without additional cost to the Owner to clear all obstructions, permit proper clearances for the Work of other trades, and present an orderly appearance where exposed. Prior to beginning such Work, the Contractor shall prepare coordination drawings showing the exact alignment, physical location and configuration of the Mechanical, Electrical and Fire Protection installations and demonstrating to the Contractor's satisfaction that the installations will comply with the preceding sentence.
- 1.2.9 Exact locations of fixtures and outlets shall be obtained from the Architect as provided in Subparagraph 3.2.2 before the Work is roughed in; Work installed without such information from the Architect shall be relocated at the Contractor's expense.
- 1.2.10 Test boring or soil test information included with the Contract documents or otherwise made available to the Contractor was obtained by the Owner for use by the Architect in the design of the Project or Work. The Owner does not hold out such information to the Contractor as an accurate or approximate indication of subsurface conditions, and no claim for extra cost or extension of time resulting from reliance by the Contractor on such

information shall be allowed except as provided in Subparagraph 15.1.8.

1.2.11 Where the Work is to fit with existing conditions or work to be performed by others, the Contractor shall fully and completely join the Work with such conditions or work, unless otherwise specified.

11. ARTICLE 3.1 CONTRACTOR

Add the following to the end of 3.2.1:

If the Contractor proceeds with the Work without such notice to the Architect, having discovered such errors, inconsistencies or omissions, or if by reasonable study of the Contract documents the Contractor could have discovered such, the Contractor shall bear all costs arising therefrom.

Add the following to the end of 3.2.2:

The Contractor shall give the Architect timely notice of any additional Drawings, Specifications, or instructions required to define the Work in greater detail or to permit the proper progress of the Work. The Contractor shall not proceed with any Work not clearly and consistently defined in detail in the Contract documents but shall request additional Drawings or instructions from the Architect. If the Contractor proceeds with such Work without obtaining further Drawings, Specifications or instructions, then the Contractor shall correct Work incorrectly done at the Contractor's own expense.

Add the following sentence to the end of Subparagraph 3.4.1:

The word "provide" shall mean furnish and install complete, including connections, unless otherwise specified.

Change the first sentence of Subparagraph 3.5.1 and delete the last (2) two sentences to read as follows:

The Contractor warrants that the materials and equipment furnished under the Contract will be new and of recent manufacture unless otherwise specified, and that all Work will be of good quality, free from faults and defects, and in conformance with the Contract documents.

Add new Subparagraphs 3.5.3 through 3.5.9 as follows:

3.5.3 The Contractor shall be responsible for determining that all materials furnished for the Work meet all requirements of the Contract documents. The Architect may require the Contractor to produce reasonable evidence that a material meets such requirements, such as certified reports of past tests by qualified testing laboratories, reports of studies by qualified experts, or other evidence which, in the opinion of the Architect, would lead to a reasonable certainty that any material used, or proposed to be used, in the Work meets the requirements of the Contract documents. All such data shall be furnished at the Contractor's expense. This provision shall not

require the Contractor to pay for periodic testing of different batches of the same material, unless such testing is specifically required by the Contract documents to be performed at the Contractor's expense.

- 3.5.4 If the Contractor proposes to use a material which, while suitable for the intended use, deviates in any way from the detailed requirements of the Contract documents, the Contractor shall inform the Architect in writing of the nature of such deviations at the time the material is submitted for approval and shall request written approval of the deviation from the requirements of the Contract documents.
- 3.5.5 In requesting approval of deviations or substitutions, the Contractor shall provide, upon request, evidence leading to a reasonable certainty that the proposed substitution or deviation will provide a quality of result at least equal to that otherwise attainable. If, in the opinion of the Architect, the evidence presented by the Contractor does not provide a sufficient basis for such reasonable certainty, the Architect may reject such substitution or deviation without further investigation.
- 3.5.6 The Contract documents are intended to produce a building of consistent character and quality of design. All components of the building including visible items of mechanical and electrical equipment have been selected to have a coordinated design in relation to the overall appearance of the building. The Architect shall judge the design and appearance of proposed substitutes based on their suitability in relation to the overall design of the Project, as well as for their intrinsic merits. The Architect will not approve as equal to materials specified proposed substitutes which, in the Architect's opinion, would be out of character, obtrusive, or otherwise inconsistent with the character of quality of design of the Project. In order to permit coordinated design of color and finishes the Contractor shall, if required by the Architect, furnish the substituted material in any color, finish, texture, or pattern which would have been available from the manufacturer originally specified, at no additional cost to the Owner.
- 3.5.7 Any additional cost, or any loss or damage arising from the substitution of any material or any method for those originally specified shall be borne by the Contractor, notwithstanding approval or acceptance of such substitution by the Owner or the Architect, unless such substitution was made at the written request or direction of the Owner or the Architect.
- 3.5.8 The warranty provided in this Paragraph 3.5 shall be in addition to and not in limitation of any other warranty required by the Contract documents or otherwise prescribed by law.
- 3.5.9 The Contractor shall procure and deliver to the Architect, no later than the date claimed by the Contractor as the date of Substantial Completion, all special warranties required by the Contract documents. Delivery by the Contractor shall constitute the Contractor's guarantee to the Owner that the warranty will be performed in accordance with its terms and conditions.

Change the title of Paragraph 3.9 to read "Superintendence."

Change the first sentence of Subparagraph 3.9.1 to read as follows:

The Contractor shall employ a competent superintendent, reasonably acceptable to the Owner, and necessary assistants who shall be in attendance at the Project site full time during the progress of the Work until the date of Substantial Completion, and for such additional time thereafter as the Architect may determine to be necessary for the expeditious completion of the Work.

Add to end of Subparagraph 3.9.3 as follows:

The Contractor shall remove the superintendent if requested to do so in writing by the Owner and shall promptly replace him with a competent person reasonably acceptable to the Owner.

Add new Subparagraphs 3.9.4 through 3.9.7 as follows:

- 3.9.4 The Contractor shall retain a competent Registered Professional Engineer or Registered Land Surveyor, acceptable to the Architect, who shall establish the exterior lines and required elevations of all buildings and structures to be erected on the site and shall establish sufficient lines and grades for the construction of associated Work such as, but not limited to, roads, utilities, and site grading. The Engineer or Land Surveyor shall certify as to the actual location of the constructed facilities in relation to property lines, building lines, easements, and other restrictive boundaries.
- 3.9.5 The Contractor shall establish the building grades, lines, levels, columns, walls and partition lines required by the various Subcontractors in laying out their Work.
- 3.9.6 The Contractor shall coordinate and supervise the Work performed by Subcontractors to the end that the Work is carried out without conflict between trades and so that no trade, at any time, causes delay to the general progress of the Work. The Contractor and all Subcontractors shall at all times afford each trade, any separate contractor, or the Owner, every reasonable opportunity for the installation of work and the storage of materials.
- 3.9.7 The Contractor shall arrange for and attend job meetings with the Architect and such other persons as the Architect may from time-to-time wish to have present. The Contractor shall be represented by a principal, project manager, general superintendent or other authorized main office representative, as well as by the Contractor's own superintendent. An authorized representative of any Subcontractor or Sub-Subcontractor shall attend such meetings if the representative's presence is requested by the Architect. Such representatives shall be empowered to make binding commitments on all matters to be discussed at such meetings, including costs, payments, change orders, time schedules, and workforce. Any

notices required under the Contract may be served on such representatives.

Change Subparagraph 3.10.1 to read as follows:

3.10.1 The Contractor shall prepare and submit to the Architect a progress schedule as described in Subparagraphs 8.2.4 through 8.2.10.

Change Subparagraph 3.12.6 to read as follows:

3.12.6 By approving and submitting Shop Drawings, Product Data, Samples, and similar submittals the Contractor thereby represents that the Contractor has determined and verified all dimensions, quantities, field dimensions, relations to existing work, coordination with work to be installed later, coordination with information on previously accepted Shop Drawings, Product Data, Samples, or similar submittals and verification of compliance with all the requirements of the Contract documents. The accuracy of all such information is the responsibility of the Contractor. In reviewing Shop Drawings, Product Data, Samples, and similar submittals the Architect shall be entitled to rely upon the Contractor's representation that such information is correct and accurate.

Add the following at the end of Subparagraph 3.12.9:

Unless such written notice has been given, the Architect's approval of a resubmitted Shop Drawing, Product Data, Sample, or similar submittal shall not constitute approval of any changes not requested on the prior submittal.

Change Subparagraph 3.13 to read as follows:

The right of possession of the premises and the improvements made thereon by the Contractor shall remain at all times with the Owner. The Contractor's right to entry and use thereof arises solely from the permission granted by the Owner under the Contract documents. The Contractor shall confine the Contractor's apparatus, the storage of materials, and the operations of the Contractor's workmen to limits indicated by law, ordinances, the Contract documents and permits and/or directions of the Architect and shall not unreasonably encumber the premises with the Contractor's materials. The Owner shall not be liable to the Contractor, their Subcontractors, their employees or anyone else with respect to the conditions of the premises, except only for a condition caused directly and solely by the negligence of the Owner.

Add the following at the end of Subparagraph 3.15.1:

Immediately prior to the Architect's inspection for Substantial Completion, the Contractor shall completely clean the premises. Concrete and ceramic surfaces shall be cleaned and washed. Resilient coverings shall be cleaned. Woodwork shall be dusted and cleaned. Sash, fixtures, and equipment shall be thoroughly cleaned. Stains, spots, dust, marks and smears shall be removed from all surfaces. Hardware and all metal

surfaces shall be cleaned and polished. Glass and plastic surfaces shall be thoroughly cleaned by professional window cleaners. All damaged, broken or scratched glass or plastic shall be replaced by the Contractor at the Contractor's expense.

12. ARTICLE 4.1 ADMINISTRATION OF THE CONTRACT

In Subparagraph 4.2.7, add to the end of the first sentence:

“...and only to the extent which the Architect believes desirable to protect the Owner's interest.”

13. ARTICLE 8.1 TIME

Added new Subparagraphs 8.1.5 through 8.1.11 as follows:

- 8.1.5 Within two (2) weeks after award of the Contract, the Contractor shall submit to the Architect a Progress Schedule showing for each class of work included in the Schedule of Values, the percentage completion to be obtained and the total dollar value of work to be completed as of the first of each month until Substantial Completion. All calculations shall be based on the Work in place, and not include the value of materials delivered, but not in place.
- 8.1.6 The Progress Schedule shall be based on an orderly progression of the Work, allowing adequate time for each operation (including adequate time for submission and review of submittals), and leading to a reasonable certainty of Substantial Completion by the date established in the Agreement. The Progress Schedule will be reviewed by the Architect for compliance with the requirements of this Article and will be accepted by the Architect or returned to the Contractor for revision and resubmittal. Unless specifically required by law, no payment under this Contract shall be due until the Progress Schedule has been approved by the Architect.
- 8.1.7 If in any Application for Payment the total value of the completed Work in place, as certified by the Architect, is less than 90% of the total value of the Work in place estimated in the Progress Schedule, the Owner may, at the Owner's option, require the Contractor to accelerate the progress of the Work without cost to the Owner by increasing the work force or hours of work, or by other reasonable means approved by the Architect.
- 8.1.8 If each of three (3) successive applications, as certified by the Architect, indicate that the actual Work completed is less than 90% of the values estimated in the Progress Schedule to be completed by the respective dates, the Owner may at the Owner's option, treat the Contractor's delinquency as a default justifying the action permitted under Paragraph 14.2.
- 8.1.9 If the Architect has determined that the Contractor should be permitted to extend the time for completion as provided in Paragraph 8.3, the calendar

dates in the Progress Schedule shall be adjusted accordingly to retain the same relationship to the adjusted date of Substantial Completion, and the dollar value of Work to be completed as of the first of each month shall be prorated.

8.1.10 If the Contractor fails to submit any Application for Payment in any month, the Architect shall, for the purpose of this evaluation of progress, certify separately to the actual value of the Work in place completed as of the first of the month to the best of the Architect's knowledge.

8.1.11 Nothing herein shall limit the Owner's right to liquidated or other damages for delays by the Contractor or to any other remedy which the Owner may possess under other provisions of the Contract Documents or by law.

Change Subparagraph 8.3.3 and add new Subparagraph 8.3.4 as follows:

8.3.3 No claim for delay shall be allowed on account of failure of the Architect to furnish Drawings, Specifications, or instructions or to return Shop Drawings or Samples until fifteen (15) days after receipt by the Architect by registered or certified mail of written demand for such instructions, Drawings, or Samples, and not then unless such claim be reasonable.

8.3.4 The Contractor hereby agrees that the Contractor shall have no claim for damages of any kind against the Owner or the Architect on account of any delay in the commencement of the Work and/or any delay or suspension of any portion of the Work, whether such delay is caused by the Owner, the Architect, or otherwise. The Contractor acknowledges that the Contractor's sole remedy for any such delay and/or suspension will be an extension of time as provided in this Article.

14. ARTICLE 9.1 PAYMENTS AND COMPLETION

Add at the end of the second sentence of Subparagraph 9.2:

"and shall be revised if later found by the Architect to be inaccurate."

Add new Subparagraph 9.3.4 as follows:

9.3.4 Each Application for Payment or periodic estimate requesting payment shall at the Owner's option be accompanied by: (1) a waiver of liens from each Subcontractor; or (2) a certificate from each Subcontractor stating that the Subcontractor has been paid all amounts due the Subcontractor on the basis of the previous periodic payment to the Contractor or else stating the amount not so paid and the reason for the discrepancy. In the event of any such discrepancy, the Contractor shall furnish the Contractor's own written explanation to the Owner through the Architect. Such waiver or certificate shall be in a form acceptable to the Owner.

In Subparagraph 9.5.1, add the new item to the list of .1 through .7 as follows:

- .8 failure of mechanical trade or electrical trade Subcontractors to comply with mandatory requirements for maintaining record drawings. The Contractor shall check record drawings each month. Written confirmation that the record drawings are current will be required by the Architect before approval of the Contractor's monthly payment requisition.

Replace the second sentence of Subparagraph 9.10.2 with the following:

If the Contractor fails to furnish such releases or waivers, as the Owner reasonably requires, to satisfy the Owner that there are not outstanding liens, the Owner may require the Contractor, as a condition of final payment and at the Contractor's expense, to furnish a bond satisfactory to the Owner to indemnify the Owner against any such liens.

15. ARTICLE 10.1 PROTECTIONS OF PERSONS AND PROPERTY

At the end of the Subparagraph 10.1, add the following:

"... including compliance with 29 CFR 1910.132, 1910.133, and 1910.134, and for providing a safe workplace and complying with all codes, bylaws, rules and regulations applicable to the construction site."

In Subparagraph 10.2.1.2 delete the word "and" at the end of the Subparagraph.

In Subparagraph 10.2.1.3 add the word "and" to the end of the Subparagraph.

In Subparagraph 10.2.1, add the new item to the list of .1 through .3 as follows:

- .4 any other property of the Owner, whether or not forming part of the Work, located at the site or adjacent thereto in areas to which the Contractor has access.

Add new Subparagraphs 10.2.9 through 10.2.12 as follows:

10.2.9 The Contractor shall provide and maintain in good operating condition suitable and adequate fire protection equipment and services and shall comply with all reasonable recommendations regarding fire protection made by the representatives of the fire insurance company carrying insurance on the Work or by the local Fire Chief or Fire Marshal. The area within the site limits shall be kept orderly and clean, and all combustible rubbish shall be promptly removed from the site.

10.2.10 The Contractor shall, at all times, protect excavations, trenches, buildings and materials, from rainwater, ground water, backup or leakage of sewers, drains and other piping, and from water of any other origin and shall remove promptly any accumulation of water. The Contractor shall provide and operate all pumps, piping, and other equipment necessary to this end.

10.2.11 The Contractor shall remove snow and ice which might result in damage or delay.

10.2.12 During the progress of the Work and at all times prior to the date of Substantial Completion of occupancy of the Work by the Owner, whichever is earlier, the Contractor shall provide temporary heat, ventilation, and enclosure, adequate to permit the Work to proceed in a timely fashion, and to prevent damage to completed Work or Work in progress, or to materials stored on the premises. The permanent heating and ventilation systems may be used for these purposes when available unless otherwise provided in the Contract Documents.

16. ARTICLE 11.3 PROPERTY INSURANCE

Subparagraphs 11.2.2 through 11.5.2 shall be deleted in their entirety.

17. ARTICLE 12.1 UNCOVERING AND CORRECTION OF WORK

Add at the end of Subparagraph 12.2.1:

“...and any cost, loss, or damages to the Owner resulting from such failure or defect.”

18. ARTICLE 13.1 MISCELLANEOUS PROVISIONS

Change Subparagraph 13.4.4 to read as follows:

13.5.4 The Contractor shall obtain and deliver promptly to the Architect any occupancy permit and any certificates of final inspection of any part of the Contractor’s work and operating permits for any mechanical apparatus, such as elevators, escalators, boilers, air compressors, etc., which may be required by law to permit full use and occupancy of the premises by the Owner. Receipt of such permits or certificates by the Architect shall be a condition precedent to Substantial Completion of the Work.

19. ARTICLE 14.1 TERMINATION OF THE CONTRACT

Delete “or” from end of Subparagraph 14.1.1.2

Delete Subparagraphs 14.1.1.4 in its entirety.

20. ARTICLE 15 CLAIMS AND DISPUTES

Add the following sentence to the end of Subparagraph 15.1.3.1:

Any change or addition to a previously made Claim shall be made by timely written notice in accordance with this Subparagraph 15.1.3.1.

Delete the second sentence of Subparagraph 15.1.6.1 and substitute the following:

The Contractor shall have the burden of demonstrating the effect of the claimed delay on the Contract Time and shall furnish the Architect with such documentation relating thereto as the Architect may reasonably require.

Add the following Subparagraph:

15.1.6.3 Any extension of time for weather delays shall be considered by the Architect and Owner only when a request for such extension is made in writing by the Contractor and provided further that any such request shall be presented to the Architect or Owner within ten (10) days from the commencement of the period of delay.

It is expressly understood and agreed that the Contract Time includes adequate time to allow for usual weather/smoke delays considering the climatic conditions in the area of the Project. No adjustments to the Contract Time will be allowed on account of usual weather or subsequent building/site conditions. The Contractor shall include adequate float or other allowance in the Contractors construction schedule to accommodate weather conditions that may be associated with weather dependent work. Any extension of time for weather will be per specifications 01310(A/B).

Time extension requests for delays caused by additional adverse weather conditions will be evaluated individually. Inclement weather days in which no work is conducted at the project site will be considered by the Owner for full day time extensions. Inclement weather days in which any trade or worker perform work on the project will be considered by the Owner for a maximum of one-half ($\frac{1}{2}$) daytime extension.

SECTION 00810 – WAGE RATES AND APPRENTICE UTILIZATION

The Contractor shall comply strictly with the requirements of **NRS Chapter 338** and shall pay, if required by statute, prevailing wage rates for the appropriate labor positions as outlined in "Washoe County - Prevailing Wage Rates for Public Works, State of Nevada" for projects that are \$100,000 or greater. Prevailing wage shall be paid for all work through punch list and issuance of Notice of Completion.

Wage rates as published by the Labor Commissioner of the State of Nevada are available as follows:

Office of Labor Commissioner
1818 College Parkway, Suite 102
Carson City, NV 89706

- Phone: (775) 684-1890
- Email: mail1@Labor.nv.gov
- Website: <https://labor.nv.gov/>

The Contractor shall comply strictly with the requirements of **NRS Chapter 338 and the Apprentice Utilization Act** as reformed by Senate Bill 82 (SB82) in the 2023 Legislative Session effective January 1, 2024. Please refer to the Labor Commissioner's website specifically for a copy of [Senate Bill 82](#), [Presentation Senate Bill 82 dated 12-12-23](#), [Senate Bill 82 OLC Summary dated 12-12-23](#) and any other posted information.

(https://labor.nv.gov/Apprenticeship_Utilization_Act/Apprenticeship_Utilization_Act/)

A contractor or subcontractor engaged in Public Works construction who employs workers on one or more public works during a calendar year pursuant to NRS 338.040 shall use apprentices for a portion of the total hours of labor worked for each apprenticed craft or type of work to be performed on those public works.

This project is subject to the Apprentice Utilization Act and is categorized as **HORIZONTAL** work.

It is the Contractor's responsibility to comply, document and report directly to the Labor Commissioner annually if they have performed a certain number of hours or more on Public Works. Failure to comply, document and report could result in financial penalties and disqualification per NRS.

SECTION 00820 - SPECIAL CONDITIONS

1. TIME OF COMPLETION

The physical work is to commence upon issuance of a Notice to Proceed and shall be completed on or before **August 1, 2025**.

2. EXAMINATION OF SITE

Contractor is requested to visit the project site, compare the Drawings and Specifications with any work in place, and be informed of all conditions, including the work, if any, being performed. Failure to visit the project site will in no way relieve the Contractor from necessity of furnishing any materials or performing any work in accordance with Drawings and Specifications that may be required to complete the work without additional cost to the Owner.

The Contractor shall call the project site and make arrangements for a time to visit. To review the existing premises, contact the Principal and/or Site Facilities Coordinator at the site(s). **Whenever at the site, be sure to check in at the Front Office.**

3. STORAGE

If available as determined by the Capital Projects Department, the Contractor may make arrangements with the Capital Projects Department for an area which the Contractor may use for storage of tools, equipment, and supplies while the project is in progress. Contractor to provide own storage unit for self and any Subcontractors.

4. UTILITIES

If available as determined by the Capital Projects Departments, the Contractor may make arrangements with the Capital Projects Department for the use of all water, electricity, lighting, and other utilities necessary for construction purposes. However, the Contractor shall furnish at his/her own expense any lines or equipment, or extensions necessary to bring utilities to construction areas including any design, permitting, fees, hookup, etc. to execute the use of the utility.

5. TOILETS

If available as determined by the Capital Projects Department, the Contractor may make arrangements with the Capital Projects Department for toilets as necessary for use of workers. Toilets must be kept in sanitary condition and are the responsibility of the Contractor. Additional toilets may be required to be provided by the Contractor if weekend or after hour work is anticipated.

6. BUILDING CODES

All work in this project shall strictly comply with ordinances and laws, state and

local, governing such construction in this locality.
Should the Drawings and/or Specifications in any way conflict with these ordinances and laws, the Contractor shall immediately notify the Owner.

7. WAGES

- a. Wage Rates – The Contractor shall comply strictly with the requirements of NRS [Chapter 338](#) and shall pay, if required by statute, prevailing wage rates for the appropriate labor positions as outlined in "Washoe County - Prevailing Wage Rates for Public Works, State of Nevada" for projects that are \$100,000 or greater
- b. Nondiscrimination - In connection with the performance of the work under this Contract, the Contractor agrees not to discriminate against any employee or applicant for employment because of race, creed, color, national origin, or sex. Such agreement shall include, but not be limited to, the following: employment, upgrading, demotion or transfer, recruitment, or recruitment advertising, layoff or termination, rates of pay or other forms of compensation, and selection for training, including apprenticeship. The Contractor further agrees to insert this provision in all subcontracts hereunder, except subcontract for standard commercial supplies or raw materials. Any violation of these provisions by a Contractor or Subcontractor shall constitute a material breach of Contract.
- c. Health and Safety in Employment - All applicable provisions of NRS [Chapter 618](#) shall be incorporated in the construction practices for all employees directly engaged in the completion of this project.

Safety: In accordance with generally accepted construction practices, the Contractor will be solely and completely responsible for condition of the job site, including safety of all persons and property during performance of the work. This requirement will apply continuously and not be limited to normal working hours.

The duty of the Engineer/Architect to conduct construction review of the Contractor's performance is not intended to include review of the adequacy of the Contractor's safety measures.

- d. Hours - No overtime or weekend work on the project will be performed without the written approval of the Owner or Owner's representative except in cases of emergency where life or property is in imminent danger. The Contractor may submit a request for overtime, weekend or holiday work to the Capital Projects Department for review and approval or denial, a minimum of one (1) week prior to such work. It shall be the Contractor's responsibility to pay, as a Deductive Change Order, any overtime costs associated with such work for WCSD personnel to open/close site, provide quality assurance and quality control for such work.

WCSD has the right to reject any overtime, holiday or weekend work.

No person shall be employed for more than eight (8) hours in any one day or

more than forty (40) hours in any one week without proper overtime compensation being paid.

During occupied periods, the Contractor can only work with the WCSD's permission. During these occupied periods, the Contractor will be responsible for the complete clean-up and weatherproofing of any work each day in order that the space can be utilized for its educational purpose the next day.

The cost of these "off" hours shall be included in the bid.

From 7:00 am to 7:00 pm – Monday Through Friday the site will be available to the Contractor.

- e. Employment – Contractors shall comply with NRS [Chapter 338.125](#) and [Chapter 338.130](#) inclusively. The Contractor expressly agrees to comply with the provisions of [Chapter 338.130](#) and further agrees that if those provisions are not complied, or any failure or refusal to comply with the provisions of [Chapter 338.130](#), shall render this Contract VOID.
- f. Statutes - All applicable provisions of NRS [Chapter 338](#) shall apply to this project and Contract and all Contractor and Subcontractors shall comply therewith.
- g. Workers' Compensation - Workers' Compensation premiums shall be paid as required by law for the duration of the Contract practices delineated under "Occupational Safety and Health" (NRS [Chapter 618](#)) and will be adhered to in all phases of construction.

8. PERMITS AND INSPECTIONS

- a. Since the project site is within Washoe County, City of Reno or City of Sparks, the Contractor shall secure a building permit and arrange for all inspections through the appropriate jurisdiction. WCSD is not exempt from the requirements of these authorities.
- b. Any fees charged by Washoe County, City of Reno, or City of Sparks, for permanent improvements plan checking, permits and water, sewer, electrical hook-up will be paid by WCSD.
- c. The Contractor shall give all notices as required and comply with all laws, ordinances, rules, and regulations bearing on the conduct of the work as drawn and specified. If the Contractor observes that the Specifications and/or Drawings are at variance therewith, the Contractor shall notify the Owner promptly in writing, of any necessary changes in the work. If the Contractor performs any work knowing it to be contrary to such laws, ordinances, rules, and regulations, and without such notice to the Owner, the Contractor shall bear all costs arising therefrom.
- d. The Contractor shall notify the Owner when ready for final inspection.

- e. Final payment shall not be made until the original closed out permit for the work has been turned over to the Owner.

9. EMPLOYEE REGULATIONS

The Contractor shall, at all times, enforce strict discipline and good order among employees and shall not employ on the work any unfit person or anyone not skilled in the work assigned to him.

The Contractor shall ensure that each and every kind of work shall be performed by workmen, laborers, or mechanics especially skilled in the class of work (trade) required and that workmanship shall be of the best trade practice, regardless of the quality of materials.

The Contractor shall provide, at all times, sufficient and competent labor to carry on the work properly and ensure completion of each part in accordance with schedule and within the time agreed to.

An employee of the Contractor or Subcontractor, who is deemed incompetent, disorderly, or otherwise objectionable by the Owner, shall be removed promptly by the Contractor, and not reemployed on the work.

10. MANUFACTURER'S SPECIFICATIONS AND RECOMMENDATIONS

Wherever, in these specifications, a particular brand or make of item is specified, the Contractor shall comply strictly with the specifications and recommendations of that manufacturer as to the installation and/or application of that particular item.

11. REFERENCE TO SPECIFICATIONS AND TRADE NAMES

In these Specifications, wherever American Society for Testing Materials or other specifications or standards are mentioned it shall be understood that the materials or methods mentioned therewith shall conform to all requirements of the issue in effect on date of submission of bids. In these specifications whenever the trade name of a product or the name of a manufacturer appears it shall be understood to specify the product so identified or its "Approved Equal." The words "Or Equal" or "Approved Equal" shall mean equal in the opinion of and approved by the Owner or its representative. Refer to requirements outlined in Section 01631 - SUBSTITUTIONS.

12. NOTIFICATION TO CONTRACTOR OF WORK TO BE PERFORMED

After award of the bid, the project shall be initiated by the successful execution of a Contract and a "Notice to Proceed" has been issued by the WCSD's Purchasing Department.

13. GUARANTEE

The Contractor shall guarantee all work and equipment provided under this

Contract to be free from defects of workmanship and material for a period of **one (1) year** or as specified, from the date of final acceptance of the work, which constitutes the issuance of a Notice of Substantial Completion and shall, at Contractor's own expense, repair and replace all defective work and materials.

14. APPEAL BY UNSUCCESSFUL BIDDER

Any unsuccessful Bidder (Appellant) may appeal the results in the solicitation's RECOMMENDATION OF AWARD TABULATION if they believe applicable provisions of the law were violated.

Appellant must submit a notice of protest to the Director of Procurement and Contracts no later than five (5) business days beginning the day after the date of the ROA TABULATION.

The notice of protest must include a written statement setting forth with specificity the reasons the person filing the notice believes the applicable provisions of the law were violated.

Appellant shall submit with the notice of protest a bond (i.e., Protest Bond or Appeal Bond) with a good and solvent surety company, authorized to do business in the State of Nevada or submit other security in a form approved by WCSD, who will hold the bond or other security until a determination is made on the appeal.

The bond shall be in the amount of twenty-five percent (25%) of the total dollar value of the Appellant's bid submission, up to a maximum amount of two hundred fifty thousand dollars (\$250,000).

If Appellant is not satisfied with WCSD's Director of Procurement and Contracts' response, Appellant may then appeal to an appeals committee designated by WCSD.

If Appellant is not satisfied with the appeals committee's response, Appellant may then appeal to WCSD's Board of Trustees, who will render the final decision.

WCSD will postpone any award action until after WCSD's Board of Trustees renders a final decision.

Appellant will not seek any type of judicial intervention until WCSD has rendered its final decision on the protest.

If an appeal is granted, the full amount of the posted bond will be returned to Appellant.

If the appeal is denied/not upheld, a claim may be made against the bond by WCSD for expenses suffered by WCSD as a result of the unsuccessful appeal.

WCSD is not liable for any costs, expenses, attorney's fees, loss of income, or other damages sustained by Appellant in an appeal process.

15. QUALITY ASSURANCE

It shall be the Contractor's responsibility to use adequate numbers of skilled workers who are thoroughly trained and experienced in the necessary crafts and who are completely familiar with the specified requirements and the methods needed for proper performance of the work.

16. OTHER PROJECTS

The Contractor is hereby informed that other projects may be happening at the school/ site at the same time as this project. The Contractor will make every effort to coordinate work with that of other Contractors.

17. EXISTING BUILDING AND CONDITIONS

During construction, it shall be the responsibility of the Contractor to take all reasonable precautions to preserve and protect surrounding buildings and property from damage of all kinds arising from the execution of this Contract. He/she shall repair and/or be responsible for any such damage at no additional cost to the Owner.

It is the Contractor's responsibility to identify and document any building or site damage that exists prior to the start of construction. If undocumented damage is discovered by the Owner that could have been caused as a result of the Contractor's presence it will be the Contractor's responsibility to repair the damage to the Owner's satisfaction without cost to the Owner. If the Contractor does not repair the damage to the Owner's satisfaction, then the Owner has the right after forty-eight (48) hours of written notification to repair the damage and process an Owner's Deductive Change Order for all expenses associated with the repair.

The Contractor shall provide temporary protective fencing or covering over any open trenching or excavation arising from the execution of this Contract, to keep out unauthorized persons, at no additional cost to the Owner.

The Contractor shall notify the Capital Projects Department's representative forty-eight (48) hours prior to any electrical shutdowns at the project site. Failure to do so could cause freezing and other damage due to shut down of the energy management system. The Contractor shall bear all costs for damage resulting from any failure to notify designated parties.

The Contractor shall meet with the representative of the Capital Projects Department to establish limits of work and general ground rules. As school may be in session, all safety precautions will be rigidly enforced.

Contractor shall hire a qualified, properly Licensed Contractor to test all natural gas lines within area of work for leaks prior to the start of the project and at project completion. Note all gas leaks at the start of the project and report it to the Capital Projects Department's representative IMMEDIATELY. Contractor shall not proceed with work in area of any leaks until directed by the Capital Projects

Department's representative. Gas line leaks at project completion shall be the responsibility of the Contractor and be repaired by a qualified, Licensed Contractor at no cost to the Owner. Contractor shall assume that all exposed conduit that exists within the work area is fully functional and operational for all wiring that is within the conduit at the start of the project. If at any time during construction, operations utilizing this wiring fail or are disrupted, the Contractor shall be responsible for repairs to make the operations fully functional by a qualified, Licensed Contractor at no cost to the Owner.

18. MATERIAL DISTURBANCE PERMIT

The Building Material Disturbance Permit (MDP) is a Washoe County School District (WCSD) document that identifies asbestos and lead site specific information, and it is issued by the Environmental, Safety & Assessment (ES&A) Department. A site-specific Material Disturbance Permit is required for each project. Each project and facility require a separate Material Disturbance Permit because each facility has specific information and direction regarding asbestos and lead, as each facility is different in that regard. The Material Disturbance Permit is to be requested by the Project Manager, or appointed District representative, in accordance with current Material Disturbance Permit requirements. No work can be done by a Contractor in WCSD without an MDP.

19. WATER SYSTEM DISTURBANCE

Improper closing of valves and other improperly conducted disruptions to District facilities can result in cross connections and back siphoning of chemicals and other contaminants into the water supply. Since these disturbances are very important, the District has added a water system disturbance section to the Material Disturbance Permit (MDP). Work, as a part of this contract, may involve the disturbance of a facilities water distribution system and, as such, the contractor is required to comply with the Water System Disturbance Permit Appendix section of the Material, Water & Lead Disturbance Permit for any work impacting a facility water system.

The contractor shall carefully comply with all requirements of the Material, Water & Lead Disturbance Permit, and shall be aware of this process prior to bid preparation and any construction. The permit requirements are hereby made a part of this specification and contract to the same extent as if bound herein and shall apply to all contractors and subcontractors.

The contractor shall be responsible for all costs incurred by the Washoe County School District, including the consultant, sampling and testing, clean-up, replacement of effected equipment, materials, etc., and any legal action that may result from an unauthorized disturbance of a water system caused by the contractor or his subcontractors, resulting in a cross connection or backflow incident.

If Contractors have any questions regarding the requirements of the Water System Disturbance Permit, please call the ES&A Department for the Regulated Systems

Compliance & Safety Officers at (775) 325-8491.

20. ASBESTOS

The Washoe County School District has approx. 60% of our facilities that contain asbestos-containing materials. Contractors performing disturbances to asbestos-containing materials must be properly licensed and trained per the EPA AHERA regulation, as well as other Federal, State, and Local regulations.

Since so many of the facilities contain asbestos, minor construction activities many times will involve disturbance of materials which contain asbestos. These projects may involve “small scale-short duration” asbestos disturbances also termed “Attachments & Penetrations” to non-friable materials. As a part of this contract, the successful contractor will be required to include Attachments & Penetrations into the scope of their work.

a. Asbestos and the Material Disturbance Permit

The Contractor shall carefully comply with all the items of the Building Material Disturbance Permit (MDP) and shall review the permit and become familiar with its contents prior to bid preparation and any construction.

Once a Material Disturbance Permit Request is received for a specific project, building materials that have been identified as being disturbed during construction, and/or demolition, will have been tested for the presence of asbestos. These materials will be identified as asbestos-containing or non-asbestos-containing on the building Material Disturbance Permit(s) by the District’s AHERA Management Planner. The Material Disturbance Permit must be referred to before any work commences. No outside asbestos sampling of building materials, by the Contractor or a Contractor hired asbestos consultant, is allowed.

All asbestos-containing material must be handled by contractors and/or individuals trained and certified in the removal of asbestos-containing building materials. No asbestos-containing materials shall be disturbed prior to authorization from the owner. If any material is encountered that is not listed on the Material Disturbance Permit, it shall immediately be brought to the attention of the Project Manager before any work continues that might disturb this material. If any building material listed in the disturbance permit as containing asbestos is improperly disturbed, in the opinion of the District, by the Contractor or his sub-contractor/s, the District will immediately hire a third-party asbestos consultant to investigate possible asbestos contamination, and an asbestos Contractor to perform any recommended clean-up.

The Contractor shall be responsible for all costs incurred by the District including the consultant, sampling and testing, clean-up, replacement of affected equipment, materials, etc., and any legal action that may result from an asbestos fiber release incident caused by the Contractor or his sub-contractors.

b. Asbestos Abatement (The removal of an asbestos material)

Attachments and Penetrations does not include the removal (other than drilling holes) of asbestos containing materials. Any removal of asbestos-containing materials is not an “Attachment and Penetration” activity, but rather an abatement, and any abatement of asbestos materials must be designed by an EPA AHERA certified Asbestos Project Designer. Any abatement project’s design will be the responsibility of the District to design and provide abatement specifications. Asbestos abatement (Removal) must be conducted by an asbestos abatement contractor, which will be supervised by the District and/or a District hired asbestos abatement consultant. The abatement costs will be included into the scope of this project.

c. Asbestos – Attachments & Penetrations

Attachments & Penetrations, for the purpose of this document, is the drilling of holes, installing/removing screws, installing anchors, nails, and staples in non-friable asbestos-containing materials, in which the disturbance may release asbestos fibers. Attachments & Penetrations are minor disturbances that are normal activities such as installing conduits, mounting boxes or brackets, and removing equipment anchors from asbestos containing materials. The Material Disturbance Permit will identify which materials at a specific site can be disturbed, and the minimum requirements to perform an asbestos disturbance.

d. “Small Scale-Short Duration” – WCSD Attachment & Penetration Procedures

The WCSD Attachment & Penetration Procedures that the Contractor must utilize, when identified as being required in the MDP, are available from the Project Manager. The contractor shall submit their WCSD Attachment & Penetration Procedures to the Project Manager. The Project Manager will submit the documents to the ES&A Department for approval.

The contractor can add additional requirements, but nothing required in the MDP and WCSD Attachment & Penetration Procedures may be omitted. The Contractor must submit their Attachment & Penetration Procedure to their Project Manager to get ES&A approval of these documents **prior to any disturbance.** The ES&A Department will notify the contractor upon approval of these documents.

Once the approval of the WCSD Attachment & Penetration Procedure and training certificates is received, the contractor may schedule the disturbance, but must notify the ES&A Department immediately prior to disturbing the asbestos-containing materials. The Contractor shall provide this notice by calling the ES&A Attachment & Penetration hotline at 325-8490, follow the directions, and leave a message. ES&A Department personnel, Project Managers, Assistant Project Managers/PCI’s, and other

district personnel may conduct site visits to ensure compliance with the contractor's submitted and approved procedures.

e. Asbestos Training Certificates – Abatement

Abatement of asbestos-containing materials, as allowed and identified in the Material Disturbance Permit, will be done by an Asbestos Abatement Contractor, with workers that have a minimum of 32-hour AHERA asbestos training (Asbestos Worker), and supervised by an abatement supervisor with 40-hour AHERA asbestos training (Contractor/Supervisor). Workers and supervisors must also get an annual refresher certificate if the original training is greater than one year old. Contractor training certificates will be submitted to the Project Manager at least two weeks prior to the start of the project. The ES&A Department will review the submitted training documentation, verify certificates as required, and approve the abatement workers and supervisors, so they can work on the assigned WCSD project. No one that has not been approved by the ES&A Department is authorized to perform any asbestos disturbances within the WCSD.

New workers added after the start of the project will be approved by the ES&A Department within one 8-hour work period of the standard Monday thru Friday work schedule. Certification submittal will be serviced by the ES&A Department on a first come, first served basis. Delays to review the documentation will be anticipated and taken into account on any abatement schedule developed, and asbestos workers and supervisors will not be allowed to work in any way on that project until their documentation has been reviewed and approved.

f. Asbestos Training Certificates – Attachment & Penetration

Contractors performing “Attachment & Penetration” work on non-friable asbestos-containing materials, as allowed, and identified in the Material Disturbance Permit, will be required to have a minimum of 16 hours of AHERA asbestos training (Operations & Maintenance, or O&M), as well as an annual refresher certificate if the original training is greater than one year old. Contractor training certificates will be submitted to the Project Manager at least two weeks prior to the start of the project. The ES&A Department will review the submitted training documentation, verify certificates as required, and approve the Attachment & Penetration technicians, so they can work on the assigned WCSD project. No one that has not been approved by the ES&A Department is authorized to perform any asbestos disturbances within the WCSD.

New workers added after the start of the project will be approved by the ES&A Department within one 8-hour work period of the standard Monday thru Friday work schedule. Certification submittal will be serviced by the ES&A Department on a first come, first served basis. Delays to review the documentation will be anticipated and taken into account on any Attachment & Penetration schedule developed, and Attachment & Penetration technicians will not be allowed to work in any way on that project until their documentation has been reviewed and approved.

g. Asbestos Air Sampling, Respiratory Protection, and Protective Suits

Asbestos personal air sampling is required during any asbestos disturbance. Asbestos air sampling results will be supplied to the ES&A Department, and the Project Manager, within 48 hours of the completion of a disturbance. Laboratory results will be emailed directly to the ES&A Department from the laboratory providing analysis. Handwritten results will not be allowed. Regardless of air sampling results, Contractors will not be allowed to submit a Negative Exposure Assessment so that they can discontinue the use of respirators and personal protective suits. The District reserves the right to require this requirement, to reduce the long-term exposure liability from Contractors and their workers, which have disturbed this owner's asbestos materials.

If training certificates are issued for a class, those training certificates need to be submitted. Wallet cards will not be accepted as a training certificate unless no training certificate is provided by the training provider. In order for a wallet card to be accepted, the contractor will supply a letter from the training provider stating that no training certificate was provided, and only wallet cards were supplied to attendees. Wallet cards are less desirable due to their small size and mitigate the ability to clearly read and verify all the information on the card. Contractors are encouraged to request a full size 8 1/2" x 11" training certificate from their training providers.

21. LEAD PAINTS, COATINGS, CERAMIC TILE, AND LEAD-CONTAINING MATERIALS IN WCSD FACILITIES

a. Lead-containing paints, coatings, ceramic tile, and lead materials are present in WCSD facilities.

Bidders/Contractors that disturb lead-containing or potentially lead-containing paints, coatings, ceramic tile, and lead-containing materials, by law, are required to know all applicable regulations, and comply with all state and federal regulations that apply to the disturbances to lead-containing paints, coatings, ceramic tile, and lead-containing materials they are conducting. The regulations that are recommended by the District for a contractor to be properly trained and knowledgeable related to lead disturbances, includes, but is not limited to, the following:

OSHA Regulation CFR 1926.62 – Lead & Appendix A, B, C, & D – Lead Construction Standard.

OSHA Regulation CFR 1910. 1025 - Lead & Appendix A, B, C, & D – General Industry Standard.

EPA, 40 CFR Part 745 – Lead; Renovation, Repair, and Painting Regulation.

b. Lead and the Material Disturbance Permit

The Contractor shall carefully comply with all items of the Building Material Disturbance Permit (MDP) and shall review the permit and become familiar with its contents prior to bid preparation and any construction.

Once a Material Disturbance Permit request is received for a specific project, building materials that have been identified as being disturbed during construction, and/or demolition, will have been tested for the presence of lead. These materials will be identified as lead-containing or not lead-containing on the building Material Disturbance Permit(s) by the District's ES&A Staff. The Material Disturbance Permit must be referred to before any work commences. **No outside lead sampling of building materials, by the Contractor or a Contractor hired lead consultant, is allowed.**

All lead-containing materials must be handled by contractors and/or individuals trained and certified to perform lead disturbances. No lead-containing materials shall be disturbed prior to authorization from the owner. If any building material listed in the disturbance permit as lead-containing are improperly disturbed, in the opinion of the District, by the Contractor or his sub-contractor, the District will immediately hire a third-party lead consultant to investigate possible lead contamination, and a lead removal Contractor to perform any recommended clean-up.

The Contractor shall be responsible for all costs incurred by the District, including the consultant, sampling and testing, clean-up, replacement of the affected equipment, materials, etc., and any legal action that may result from a lead contamination incident caused by the Contractor or his sub-contractors.

Bidders/Contractors accept and acknowledge, by signing the Material Disturbance Permit, the existence of lead related regulations, and accept all liability related to the disturbance of lead-containing materials, citations resulting from, or any other costs the District may incur by the action of all parties of the bidders' company or companies hired by the successful bidder to complete this project.

c. Construction Age of Buildings in the District

At the conception of adding lead information to MDP's, it was thought that lead-containing paints, coatings, and ceramic tile were much more likely to be present on more surfaces in the District's older facilities. However, recent sampling has shown lead containing paints, coatings and ceramic tiles DO routinely exist, even in our newest facilities. Due to that finding, the age of buildings is not as important as was originally thought. We are still providing construction date information in MDP's because lead-based paint >5000 ppm is much less likely in facilities built after 1978.

d. Pre – 1978 WCSD Buildings

Paint and coating sampling have shown that paints and coatings contain

some levels of lead in the Districts' Pre-1978 facilities. Therefore, all persons performing **any** disturbance to coatings or paints in our Pre-1978 constructed facilities must utilize lead safe work practices. In addition, any person performing **any** disturbance to paints, coatings, ceramic tile, and lead-containing materials must have taken an OSHA lead action level training class from a WCSD ES&A Department approved training provider. If identified as lead-containing, the Contractor will be required to perform all disturbances as per the MDP, WCSD provided lead specification, and all local, state, and federal regulations.

e. Post – 1978 WCSD Buildings

While it was originally thought that paints and coatings on materials other than metal surfaces and ceramic tile typically did not contain lead in WCSD post – 1978 constructed facilities, sampling has shown that is not the case. The MDP will provide specific historical sampling that has been conducted in the District facilities. If past sampling has shown the presence of lead-containing paints and coatings in the facility, the Contractor will be required to treat all painted and coated surfaces as lead-containing. If identified as lead-containing, the Contractor will be required to perform all disturbances as per the MDP, WCSD provided lead specification, and all local, state, and federal regulations.

The MDP will state all buildings identified above were constructed after 1978. While it was originally thought that paints, coatings and ceramic wall tile are less likely to contain lead in newer WCSD facilities, recent sampling has shown lead-containing paints, coatings, and ceramic tiles DQ routinely exist, even in our newest facilities. Due to that finding, Contractors must treat all paints, coatings, and ceramic tile as lead-containing unless WCSD project sampling has proven otherwise, and it will be deemed negative within the MDP and the project scope. **The Bidder/Contractor must comply with all lead-containing or assumed lead-containing paint and coating disturbance instructions and requirements listed in the MDP, District provided lead specifications, and all local, state, and federal regulations, unless the material has been proven, to the satisfaction of the District, that said materials do not contain lead.**

f. Lead Removal (The removal of a lead-containing material)

Attachments and Penetrations does not include any removal, demo, welding, sanding, abrading, sandblasting, cutting, grinding, heating, and torch cutting of lead-containing materials, and is not an "Attachment and Penetration" disturbance. These activities must be designed by an EPA Certified Lead Consultant. The project's design for the above-listed activities will be the responsibility of the District to design and provide the specs as a part of this bid package. Lead activities listed above must be conducted by a lead removal contractor, which will be supervised by the District and/or District hired EPA Certified Lead Consultant. The lead activities costs will be included into the scope of each project.

g. Lead Attachments & Penetrations

Attachments & penetrations, for the purpose of this document, is the drilling of holes, installing/removing screws, installing anchors, nails, and staples, in which the disturbance may release lead dust. Attachments and Penetrations are minor disturbances that are normal activities such as installing conduits, mounting boxes or brackets, and removing equipment anchors from lead-containing materials. The Material Disturbance Permit will identify which materials at a specific site can be disturbed, and the minimum requirements to perform a lead disturbance.

h. Lead Safe Work Practices – WCSD Attachment & Penetration Procedures

The WCSD Attachment & Penetration Procedures that the Contractor must utilize, when identified as being required in the MDP, are available from the Project Manager. The contractor shall submit their WCSD Attachment & Penetration Procedures to the Project Manager. The Project Manager will submit the documents to the ES&A Department for approval.

The contractor can add additional requirements, but nothing required in the MDP and WCSD Attachment & Penetration Procedures may be omitted. The Contractor must submit their Attachment & Penetration Procedure to their Project Manager to get ES&A approval of these documents **prior to any disturbance**. The ES&A Department will notify the contractor upon approval of these documents.

Once the approval of the WCSD Attachment & Penetration Procedure and training certificates is received, the contractor may schedule the disturbance, but must notify the ES&A Department immediately prior to disturbing the lead-containing materials. The Contractor shall provide this notice by calling the ES&A Attachment & Penetration hotline at 325-8490, follow the directions, and leave a message. ES&A Department personnel, Project Managers, Assistant Project Managers/PCI's, and other district personnel may conduct site visits to ensure compliance with the contractor's submitted and approved procedures.

i. Lead Training Certificates – Removal and Attachments & Penetrations

The health and safety of all occupants of the WCSD facilities is the number one priority of the District. To that end, technicians performing disturbances to lead-containing materials must have adequate training. Contractors performing lead disturbances, as allowed and identified in the Material Disturbance Permit, will be required to have a minimum of "OSHA Lead Action Level" training, as well as an annual OSHA Lead Action Level training certificate if the original training is greater than one year old, before being approved to perform lead disturbances. OSHA Lead Action Level training will be conducted in accordance with OSHA 1926.62(1)(2)(i) thru (viii) and all required topics identified in this standard will be completed to include:

- 1926.62(l)(2)(i) The content of this standard and its appendices;
- 1926.62(l)(2)(ii) The specific nature of the operations which could result in exposure to lead above the action level;
- 1926.62(l)(2)(iii) The purpose, proper selection, fitting, use, and limitations of respirators;
- 1926.62(l)(2)(iv) The purpose and a description of the medical surveillance program, and the medical removal protection program including information concerning the adverse health effects associated with excessive exposure to lead (with particular attention to the adverse reproductive effects on both males and females and hazards to the fetus and additional precautions for employees who are pregnant);
- 1926.62(l)(2)(v) The engineering controls and work practices associated with the employee's job assignment including training of employees to follow relevant good work practices described in Appendix B of this section;
- 1926.62(l)(2)(vi) The contents of any compliance plan in effect;
- 1926.62(l)(2)(vii) Instructions to employees that chelating agents should not routinely be used to remove lead from their bodies and should not be used at all except under the direction of a licensed physician; and
- 1926.62(l)(2)(viii) The employee's right of access to records under 29 CFR 1910.20.

Certificates of Training showing that technicians have successfully completed an OSHA Lead Action Level course and are required to be properly submitted and approved by the District's ES&A Department prior to any Contractor's technician performing any disturbances to lead-containing or assumed lead-containing paints or coatings, or any other lead-containing materials. The training certificate must have "OSHA Lead Action Level Training" clearly identified on the training certificate and should have a sentence that states that the training topics covered in the class meet or exceed the training topics of OSHA 1926.62(l)(2)(i) thru (viii).

If training certificates are issued for a class, those training certificates need to be submitted. Wallet cards will not be accepted as training certificates unless no training certificate is provided by the training provider. In order for a wallet card to be accepted, the contractor will supply a letter from the training provider stating that no training certificate was provided, and only wallet cards were supplied to attendees. Wallet cards are less desirable due to their small size and mitigate the ability to clearly read and verify all the information on the card. Contractors are encouraged to request a full size 8 1/2" x 11" training certificate from their training providers.

It is important that Contractor's planning on doing the lead work within the District become familiar with the lead training requirements, and spend the time confirming that the lead classes being taken are truly an OSHA Lead Action Level course, and not a lead awareness course as identified above. Many training providers have differing training class titles on their lead

classes, but only training certificates that are noted as above will be accepted to fulfill the listed District's training requirements. Contractors requiring training are responsible in providing the training providers a clear understanding of what training is required.

Full Lead worker initial and annual training certificates that comply with adjacent state requirements for lead worker certification, will be accepted in lieu of the OSHA Lead Action Level training certificate, as long as they are titled "Lead Worker" and then accompanied with a letter from the training provider certifying that the topics identified in OSHA 1926.62(l)(2)(i) thru (viii) were covered in that class. Contractors are responsible with ensuring and verifying training certificates meet the above-listed requirements. Training certificates that do not have "OSHA Lead Action Level or Lead Worker" will not be accepted or submitted.

Contractor training certificates will be submitted to the Project Manager at least two weeks prior to the start of the project. The ES&A Department will review the submitted training documentation and must pre-approve workers so they can work on the assigned WCSD project. No one that has not been approved by the ES&A Department is authorized to perform any lead disturbances.

New workers added after the start of the project will be approved by the ES&A Department within one 8-hour work period of the standard Monday thru Friday work schedule. Certification submittal will be serviced by the ES&A Department on a first come, first served basis. Delays to review the documentation will be anticipated and taken into account on any Removal or Attachment & Penetration schedule developed, and Removal and/or Attachment & Penetration technicians will not be allowed to work in any way on that project until their documentation has been reviewed and approved.

j. Renovation, Repair & Painting Regulations (RR&P) - 40 CFR Part 745.81

Effective April 22, 2010, contractors will be required to be trained and registered with the EPA to conduct regulation applicable renovations, repairs and painting (RR&P) in all **elementary schools or child occupied District facilities constructed prior to 1978 when lead-based paints and coatings are being disturbed**. Contractors are reminded that there are some childcare facilities in middle and high school locations, and the RR&P would apply at those locations as outlined in the RR&P regulation requirements. <http://www.epa.gov/lead/pubs/steps.pdf>

In general, all firms that disturb 6 square feet of **lead-based** painted surface per room on the interior, or 20 square feet on the exterior, within a 30 day period in **this** facility, must comply with the EPA's Renovation, Repair and Painting (RR&P) regulation **and** must be registered with the federal EPA. Per the Regulation, the area of disturbance is calculated by adding up the entire surface areas being removed/disturbed, which then determines the amount of painted surface area disturbed. Work that involves window replacement or demolition of a painted surface, the EPA RR&P regulation applies regardless

of size if lead-based paint is present.

The District requires all workers in RR&P projects involving lead disturbances to have, at a minimum, OSHA lead action level training. This regulation also requires that the contractor must assign an EPA RR&P certified renovator that is responsible for ensuring and documenting all work is conducted in compliance with the EPA RR&P regulation. There are extensive record keeping and notification requirements that the Contractor must perform. All workers with the minimum OSHA lead action level training, but are not EPA RR&P certified renovator trained, must be trained and supervised by the EPA RR&P certified renovator.

On a RR&P project, Contractors must have a minimum of one EPA RR&P certified renovator on-site that has successfully attended and passed a 8-hour EPA accredited renovator training course before working in any elementary schools or child occupied District facilities constructed prior to 1978. The renovator's training certification must remain current. Recertification requirements through the attendance of refresher courses are a requirement of this regulation. The renovator must be on-site throughout the project. The certified renovator is responsible for ensuring that lead safe work practices are utilized per this EPA RR&P regulation, as well as per all District lead requirements and policies that may be more stringent than the EPA and OSHA regulations.

The EPA RR&P regulation requires that personnel disturbing lead containing materials utilize lead safe work practices as identified in the EPA guidance document titled "**steps to lead safe renovation, repair and painting**", **pages 12 through 23**. This document is available electronically at <http://www.epa.gov/lead/pubs/steps.pdf>. The contractor shall submit lead safe work practice procedures, and all RR&P and OSHA lead action level training certificates to the Project Manager at least two weeks prior to the start of the project. The ES&A Department will review the submitted training documentation and must pre-approve workers so they can work on the assigned WCSD project. No one that has not been approved by the ES&A Department is authorized to perform any lead disturbances.

New workers added after the start of the project will be approved by the ES&A Department within one 8-hour work period of the standard Monday thru Friday work schedule. Certification submittal will be serviced by the ES&A Department on a first come, first served basis. Delays to review the documentation will be anticipated and taken into account on any RR&P project schedule developed, and EPA RR&P certified renovators and workers will not be allowed to work in any way on that project until their documentation has been reviewed and approved.

This is a general overview of the regulation and the contractor must refer to the regulation for additional requirements and information. Fines are expensive and are levied toward the Contractor not the owner, so compliance with this regulation is very important, and it is important that Bidders/Contractors are well versed in this regulation.

k. **Lead Air Sampling, Respiratory Protection and Protective Suits**

Lead personal air sampling is required during any lead disturbance. Lead air sampling results will be supplied to the ES&A Department, and the Project Manager, within 48 hours of the completion of a disturbance. Laboratory results will be emailed directly to the ES&A Department from the laboratory providing analysis. Handwritten results will not be allowed. Regardless of air sampling results, Contractors will not be allowed to submit a Negative Exposure Assessment so that they can discontinue the use of respirators and personal protective suits. The District reserves the right to require this requirement, to reduce the long-term exposure liability from Contractors and their workers, which have disturbed this owner's lead materials.

22. **INDOOR ENVIRONMENTAL QUALITY**

Preventative job site practices will reduce the potential for residual problems with indoor air quality in completed buildings and reduce undue health risks for all workers. The following are the minimum standards required by the WCSD for on-site construction in the district.

a. **Existing HVAC System:**

When feasible, the HVAC system for the project area will be shut down for the duration of the project. If occupied spaces will be adversely affected by the shut-down of the system, construction area return registers should be sealed with polyethylene sheeting and secured as an alternative. Registers must be sealed prior to the start of work.

b. **Separating Occupied Spaces From Non-Occupied:**

Keep work areas separate from occupied spaces with polyethylene sheeting (or similar) if there are no other natural barriers in place OR in spaces where air exchange will occur around the barriers.

c. **Ventilation:**

During the installation of carpet, paints, furnishings and any other VOC emitting products, provide "spot" ventilation during application/installation and for at least 24 hours after the work is completed. In most cases, opening windows and doors will not be enough to effectively exhaust contaminants. It is recommended that an exhaust fan be used to pull polluted air out of the building. This can be accomplished by placing a fan in a window or door and temporarily sealing any opening around the fan with plastic. Additionally, a door or window at the opposite end of the room should be opened to allow fresh, outdoor air to flow across the work area and sweep polluted air out through the exhaust fan. As long as odors are present, the temporary exhaust ventilation must continue to operate. This may include nights and weekends, as necessary. Ventilation should continue for a minimum of 24 hours after the completion of the project or until there are no more noticeable odors.

d. **Construction Dust:**

Minimize the amount of dust in the air and on surfaces. Examples include the

use of vacuum assisted drywall sanding equipment and the use of vacuums instead of brooms to clean construction dust from floors.

- e. After Hours Scheduling:
Schedule high dust generating operations or extreme noise generating activities for after normal working hours. (i.e. saw cutting, jack hammering) and install temporary barriers to confine dust, as necessary.
- f. Gasoline/Diesel Powered Equipment:
Electric powered equipment must be used in lieu of diesel or gasoline powered equipment. Gas and diesel equipment may not be used inside a WCSD building or near an outdoor fresh air building intake.
- g. Material Safety Data Sheets (MSDS):
MSDS must be made be maintained onsite and made available upon request as required by federal law.
- h. Construction Completion:
Prior to the occupancy of the building but after the installation of new furniture, carpet, etc., the building should be flushed with 100% outside air for one to three days.
- i. Air Filters:
Replace all filtration media immediately at the conclusion of the job.
- j. Monitoring Air Quality:
Indoor air quality monitoring will be conducted randomly throughout the project. Results and any recommendations will be communicated through the building inspector to construction management.
- k. Pre-Construction Work Area Inspection:
Any overhead work including roof, the Contractor shall conduct a pre room condition walk through with WCSD Project Manager to determine the level of cleanliness that will be expected at completion of project. Contractor shall be responsible for cleaning all exposed surfaces within the facility beneath the work area. At the completion of the project, the Contractor shall clean all exposed surfaces within the facility beneath the aforementioned work area including but not limited to all shelving, duct, lighting, flooring, furniture, etc.

23. LOCK OUT TAG OUT (LOTO) PROCEDURE

Contractor will be responsible for the isolation and termination of all building systems that may be impacted by the scope of work within this bid. Contractor will coordinate all shut-down processes with the construction manager prior to any shutdowns up to and including Lock Out Tag Out procedures 24 hours prior to any shutdowns. WCSD will make the final determination of which systems and location shall be isolated. All Lock Out Tag Out will be performed at main service panel.

SECTION 00830 - TECHNICAL SPECIFICATIONS

I. SUMMARY OF THE WORK:

The work shall include the furnishing of all labor, tools, equipment, material, transportation and the performance of all operations required for the **Site Drainage Improvements at Roy Gomm Elementary School** at the site(s) and associated work as specified herein and shall include the cleanup and removal from the site(s) of all debris resulting from the operations performed. It shall also be the Contractor's responsibility to take all necessary safety precautions and to furnish barricades and/or other safety measures as required.

All work shall be performed in strict accordance with the requirements of these specifications and any and all appropriate state, county and local ordinances.

II. LOCATION OF THE WORK:

The location(s) of the work and contact person(s) are:

Roy Gomm Elementary School
4000 Mayberry Drive
Reno, NV 89519
Phone #: 775 333-5000
Principal: Barbara Barker
Site Facilities Coordinator: Santos Castellanos

The Contractor is urged to examine the site(s) and compare the existing conditions with that of the work outlined. No extra payment will be considered for work additional to that shown or noted if such work would have been apparent in an inspection of the premises.

To review the existing premises, contact the Principal and/or Site Facilities Coordinator at the site(s). **Whenever at the site, be sure to check in at the front office.**

At the above-named site(s), school classes and other construction projects may or may not be taking place during the construction phase. It will require coordination between the school site(s), other vendors, and the WCSD's Capital Projects Department.

III. QUESTIONS & CLARIFICATIONS:

For questions and clarifications regarding the Technical Specifications, Drawings, General Conditions, Special Conditions, Bidding and Contract Information contact the Purchasing Department at solicitations@washoeschools.net. **All questions shall be submitted in writing directly to WCSD's Solicitations website at <http://solicitations.washoeschools.net/> or via e-mail to solicitations@washoeschools.net by 4:30 p.m. (Local Time) on May 1, 2025.**

IV. MANUFACTURERS:

Manufacturers, types, model numbers and execution as detailed on the drawings.

V. ASBESTOS ASSESSMENT:

The Material, Water & Lead Disturbance Permit(s) are included in the Special Conditions section of the Specifications.



2024-2025 Balanced Calendar

July 2024							No School on Shaded Days
S	M	T	W	TH	F	S	# of School Days = 0
	1	2	3	4	5	6	
7	8	9	10	11	12	13	
14	15	16	17	18	19	20	
21	22	23	24	25	26	27	
28	29	30	31				

January 2025							No School on Shaded Days
S	M	T	W	TH	F	S	# of School Days = 19
			1	2	3	4	January 1 - 3 - Winter Break
5	6	7	8	9	10	11	
12	13	14	15	16	17	18	
19	20	21	22	23	24	25	January 20 - Martin Luther King, Jr. Day
26	27	28	29	30	31		

August 2024							No School on Shaded Days
S	M	T	W	TH	F	S	# of School Days = 15
				1	2	3	August 6 - 8 - Teacher Professional Dev. Days
4	5	6	7	8	9	10	August 9 - Teacher Work Day
11	12	13	14	15	16	17	August 12 - First Day of School for Students
18	19	20	21	22	23	24	August 12 - 16 - Kindergarten Testing Week
25	26	27	28	29	30	31	August 19 - First Day of Kindergarten

February 2025							No School on Shaded Days
S	M	T	W	TH	F	S	# of School Days = 19
						1	
2	3	4	5	6	7	8	
9	10	11	12	13	14	15	February 17 - President's Day
16	17	18	19	20	21	22	
23	24	25	26	27	28		February 25 - College and Career Readiness Assessment for high schools only.

September 2024							No School on Shaded Days
S	M	T	W	TH	F	S	# of School Days = 18
1	2	3	4	5	6	7	September 2 - Labor Day
8	9	10	11	12	13	14	September 9 & 11 - Emergency Closure
15	16	17	18	19	20	21	
22	23	24	25	26	27	28	
29	30						

March 2025							No School on Shaded Days
S	M	T	W	TH	F	S	# of School Days = 11
						1	
2	3	4	5	6	7	8	
9	10	11	12	13	14	15	March 14 - End of Grading Period
16	17	18	19	20	21	22	March 17 - 28 - Spring Break
23	24	25	26	27	28	29	
30	31						

October 2024							No School on Shaded Days
S	M	T	W	TH	F	S	# of School Days = 17
		1	2	3	4	5	
6	7	8	9	10	11	12	October 7 - 11 - Fall Break
13	14*	15	16	17	18	19	October 14 - Teacher Professional Dev. Day
20	21	22	23	24	25	26	October 18 - End of Grading Period
27	28	29	30	31			October 18, 21 - 24 - Conference Week
							October 25 - Nevada Day Observance

April 2025							No School on Shaded Days
S	M	T	W	TH	F	S	# of School Days = 22
		1	2	3	4	5	
6	7	8	9	10	11	12	
13	14	15	16	17	18	19	
20	21	22	23	24	25	26	
27	28	29	30				

November 2024							No School on Shaded Days
S	M	T	W	TH	F	S	# of School Days = 17
					1	2	
3	4	5*	6	7	8	9	November 5 - Election Day (See * below)
10	11	12	13	14	15	16	November 11 - Veterans Day
17	18	19	20	21	22	23	
24	25	26	27	28	29	30	November 27 - 29 - Thanksgiving Break

May 2025							No School on Shaded Days
S	M	T	W	TH	F	S	# of School Days = 21
				1	2	3	
4	5	6	7	8	9	10	
11	12	13	14	15	16	17	
18	19	20	21	22	23	24	
25	26	27	28	29	30	31	May 26 - Memorial Day

December 2024							No School on Shaded Days
S	M	T	W	TH	F	S	# of School Days = 14
1	2	3	4	5	6	7	
8	9	10	11	12	13	14	December 19 - End of Grading Period
15	16	17	18	19	20	21	December 20 - Teacher Work Day
22	23	24	25	26	27	28	December 23 - January 3 - Winter Break
29	30	31					

June 2025							No School on Shaded Days
S	M	T	W	TH	F	S	# of School Days = 7
1	2	3	4	5	6	7	June 6 - End of Grading Period
8	9*	10*	11	12	13	14	June 6 - Last Day of School
15	16	17	18	19	20	21	June 9 & 10 - Teacher Professional Dev. Days
22	23	24	25	26	27	28	June 11 - Contingency Day
29	30						June 19 - Juneteenth

*October 14, 2024, November 5, 2024, June 9, 2025 and June 10, 2025 are non-student days used for professional development but counted as days in session per NAC 387.140 (2a).	Number of Days Per Quarter	42	39	48	51	180
	Number of Days Per Semester	81		99		180
	Contingency Days: June 11					

Teacher Work Days: August 6 - 9, December 20
Teacher Professional Dev Day: October 14, 2024, November 5, 2024, June 9 - 10, 2025



2025-2026 BALANCED CALENDAR

July 2025							No School on Shaded Days
S	M	T	W	TH	F	S	# of School Days = 0
		1	2	3	4	5	
6	7	8	9	10	11	12	
13	14	15	16	17	18	19	
20	21	22	23	24	25	26	
27	28	29	30	31			

January 2026							No School on Shaded Days
J	M	T	W	TH	F	S	# of School Days = 19
				1	2	3	January 1 - 2 - Winter Break
4	5*	6	7	8	9	10	January 5 - Teacher Professional Dev. Day
11	12	13	14	15	16	17	
18	19	20	21	22	23	24	January 19 - Martin Luther King, Jr. Day
25	26	27	28	29	30	31	

August 2025							No School on Shaded Days
S	M	T	W	TH	F	S	# of School Days = 15
					1	2	
3	4	5	6	7	8	9	August 5 - 7 Teacher Professional Dev. Days
10	11	12	13	14	15	16	August 8 - Teacher Work Day
17	18	19	20	21	22	23	August 11 - First Day of School for Students
24	25	26	27	28	29	30	August 11 - 15 - Kindergarten Testing Week
							August 18 - First Day for Kindergarten Students

February 2026							No School on Shaded Days
S	M	T	W	TH	F	S	# of School Days = 19
1	2	3	4	5	6	7	
8	9	10	11	12	13	14	
15	16	17	18	19	20	21	February 16 - President's Day
22	23	24	25	26	27	28	

September 2025							No School on Shaded Days
S	M	T	W	TH	F	S	# of School Days = 21
	1	2	3	4	5	6	September 1 - Labor Day
7	8	9	10	11	12	13	
14	15	16	17	18	19	20	
21	22	23	24	25	26	27	
28	29	30					

March 2026							No School on Shaded Days
S	M	T	W	TH	F	S	# of School Days = 15
1	2	3	4	5	6	7	March 3 - College and Career Readiness Assessment for high schools only. Awaiting confirmation from NDE.
8	9	10	11	12	13	14	March 13 - End of Grading Period
15	16	17	18	19	20	21	
22	23	24	25	26	27	28	March 23 - April 3- Spring Break
29	30	31					

October 2025							No School on Shaded Days
S	M	T	W	TH	F	S	# of School Days = 17
			1	2	3	4	October 6 - 10 - Fall Break
5	6	7	8	9	10	11	October 13 - Teacher Professional Dev. Day
12	13*	14	15	16	17	18	October 17 - End of Grading Period
19	20	21	22	23	24	25	October 24, 27 - 30 - Conference Week
26	27	28	29	30	31		October 31 - Nevada Day

April 2026							No School on Shaded Days
S	M	T	W	TH	F	S	# of School Days = 19
			1	2	3	4	March 23 - April 3- Spring Break
5	6	7	8	9	10	11	
12	13	14	15	16	17	18	
19	20	21	22	23	24	25	
26	27	28	29	30			

November 2025							No School on Shaded Days
S	M	T	W	TH	F	S	# of School Days = 16
						1	
2	3	4	5	6	7	8	
9	10	11	12	13	14	15	November 11 - Veterans Day
16	17	18	19	20	21	22	
23	24	25	26	27	28	29	November 26 - 28 - Thanksgiving Break

May 2026							No School on Shaded Days
S	M	T	W	TH	F	S	# of School Days = 20
					1	2	
3	4	5	6	7	8	9	
10	11	12	13	14	15	16	
17	18	19	20	21	22	23	
24	25	26	27	28	29	30	May 25 - Memorial Day

December 2025							No School on Shaded Days
S	M	T	W	TH	F	S	# of School Days = 14
	1	2	3	4	5	6	
7	8	9	10	11	12	13	
14	15	16	17	18	19	20	December 18 - End of Grading Period
21	22	23	24	25	26	27	December 19 - Teacher Work Day
28	29	30	31				December 22 - January 2 - Winter Break

June 2026							No School on Shaded Days
S	M	T	W	TH	F	S	# of School Days = 5
	1	2	3	4	5	6	June 5 - End of Grading Period
7	8	9	10	11	12	13	June 5 - Last Day of School
14	15	16	17	18	19	20	June 9 - Primary Election Day
21	22	23	24	25	26	27	June 8, 9, 10 - Contingency Days
28	29	30					June 19 - Juneteenth

* October 13, 2025 & January 5, 2026 is a non-student day used for professional development but counted as a day in session per NAC 387.120 (4)	Number of Days per Quarter	44	39	48	49	180
	Number of Days per Semester	83	97	180		
	Contingency Days: June 8, 9, 10					

Teacher Work Days: August 5 - 8, December 19
Teacher Professional Dev Days: October 13, 2025 & January 5, 2026

BID FORM

Washoe County School District - Purchasing Department
 14101 Old Virginia Road - Reno, Nevada 89521
 Phone: 775-850-8025 Email: solicitations@washoeschools.net

Bid #: 25-100-B-04-BC
PWP # WA-2025-310

Having carefully examined all of the Bid Specifications entitled **Site Drainage Improvements at Roy Gomm Elementary School**, dated April 10, 2025; and the Drawings dated April 1, 2025; the addenda numbered _____; as well as the premises and the conditions affecting the work, the undersigned proposes to furnish for the stipulated sum of:

ITEM	DESCRIPTION	AMOUNT
A.	BASE BID 1	\$
B.	FORCE ACCOUNT	\$66,000.00
C.	TOTAL – BASE BID 1 AND FORCE ACCOUNT (The Sum of Box A + Box B): All labor and materials for the SITE DRAINAGE IMPROVEMENTS AT ROY GOMM ELEMENTARY SCHOOL as drawn and specified, the sum of _____ Dollars (\$ _____).	

Any bid submission will be disqualified and rejected if the bid submission is not signed.

Bids shall be submitted on the provided Bid Form (PUR-F523) only, and all of the blank spaces shall be completed; numbers shall be stated both in writing and in figures, the signature shall be in longhand; and the completed form shall be without interlineation, alteration or erasure. Washoe County School District only accepts signatures done manually (also known as a wet signature) or electronic digital signatures that are certified. Non-certified electronic digital signatures will NOT be accepted. A typed signature, even in cursive font, DOES NOT meet the requirements of an official digital signature. A digital signature must be accompanied by a certified digital stamp issued through programs like Adobe Acrobat, Docu-Sign or other similar programs that produce a digital stamp certifying the electronic digital signature. Any signatures on required forms that do not meet these requirements will not be accepted and the Contractor’s submission will be deemed “Non-Responsive” and will be rejected. If you have any questions about this requirement, please submit your question by the question deadline, so that it can be answered prior to quote submission deadline. In the event of a discrepancy on the Bid Form, NRS 104.3114 Contradictory terms of instrument states that, “If an instrument contains contradictory terms, typewritten terms prevail over printed terms, handwritten terms prevail over both, and WORDS PREVAIL OVER NUMBERS.” [WCSD will record the bid amount stated in WORDS in Box C.](#) Only bids on the form(s) provided will be accepted. No additional pages containing inclusions, exclusions or clarifications will be accepted as part of the bid. Any clarifications, additions or exclusions made by the Washoe County School District (WCSD/ OWNER) will be considered incorporated into the specifications.

Bidder shall proofread his/her bid carefully for errors.

WCSD reserves the right to award the bid for the best proposal for each individual item or to award on the best total proposal, whichever is deemed by the Owner to be in their best interests. WCSD also reserves the right to reject any or all bids and to waive irregularities or informalities in any bid for any reason whatsoever.

If they be notified of the acceptance of this proposal within forty-five (45) days of the time set for opening of bids, Contractor agrees to execute a contract for the above work for the above-stated compensation in the form of the contract attached within these bid specifications and to commence the physical work no fewer than ten (10) days after the execution thereof.

The undersigned agrees, if awarded the contract, work is to be commenced upon issuance of a Notice to Proceed and shall be completed on or before **August 1, 2025**. The commencement date for the physical work shall be coordinated by the Capital Projects Department upon the receipt of said Notice to Proceed. The undersigned further agrees that the Owner may retain from the monies due the Contractor One Thousand Dollars (\$1,000) per day as a direct result of the Contractor's delay for not completing the project in the required time allowance plus approved time extensions.

The undersigned agrees, if awarded the contract, to execute and deliver to the Owner, within ten (10) calendar days after delivery of notice of award of contract, an executed contract, satisfactory insurance, a performance bond for each awarded contract, and a labor & materials bond for each awarded contract in accordance with the specifications.

Enclosed is a bid bond or other surety in the amount of five percent (5%) of each total proposal (must be provided for each individual base bid item), as required in the Instructions to Bidders.

Enclosed, on the attached form, is a complete listing of the names of each subcontractor who will provide labor or a portion of the work or improvement to the prime contractor for which the subcontractor will be paid equal to or exceeding 5 percent of the prime contractor's total bid. The prime Contractor shall also add his/her name if they are performing any portion of work, including supervision, equal to or exceeding 5 percent of the total bid.

Within two (2) hours after the completion of the opening of the bids, the contractors who submitted the three lowest bids must submit on the form attached a list of each subcontractor who will provide labor or a portion of the work or improvement to the prime contractor for which they will be paid an amount equal to or exceeding 1 percent of the prime contractor's total bid or \$50,000, whichever is greater, and the number of the license issued to the subcontractor pursuant to chapter 624 NRS. If a prime contractor fails to submit such a list within the required time, their bid shall be deemed not responsive.

I have read and acknowledge that our company is in compliance with all WCSD Drug & Alcohol Requirements specified in Section 00800 – Supplementary General Conditions.

NOTE: Any bid submission will be disqualified and rejected if the bid submission is not signed. Washoe County School District only accepts signatures done manually (also known as a wet signature) or electronic digital signatures that are certified. Non-certified electronic digital signatures will NOT be accepted. A typed signature, even in cursive font, DOES NOT meet the requirements of an official digital signature. A digital signature must be accompanied by a certified digital stamp issued through programs like Adobe Acrobat, Docu-Sign or other similar programs that produce a digital stamp certifying the electronic digital signature. Any signatures on required forms that do not meet these requirements will not be accepted and the Contractor's submission will be deemed "Non-Responsive"

and will be rejected. If you have any questions about this requirement, please submit your question by the question deadline, so that it can be answered prior to bid submission deadline.

Interested parties may NOT contact anyone else regarding this solicitation. Any interested Bidder contacting any other individual including, but not limited to, WCSD staff, officials, evaluation committee members, or Board of Trustees may have their Bid submission rejected from evaluation and award consideration.

BID #: 25-100-B-04-BC

FIRM NAME:		NEVADA LICENSE #:
NAME OF AUTHORIZED REPRESENTATIVE:		
ADDRESS:		
PHONE #:	FAX #:	
EMAIL ADDRESS:		DATE:
SIGNATURE:		

1% LIST

To be submitted within two (2) hours after bid opening in accordance with Chapter 338.141 of NRS. Since all Subcontractors listed on the Bidder's 5% List are over 1% of the Bid amount, those Subcontractors shall automatically be deemed incorporated into this 1% List and need not be re-listed below. **If there are no further Subcontractors to list, please write "NONE" or "N/A" and sign document.**

PROJECT NAME: **SITE DRAINAGE IMPROVEMENTS AT ROY GOMM ELEMENTARY SCHOOL**

BID #: **25-100-B-04-BC**

DESCRIPTION OF WORK	SUBCONTRACTOR	LICENSE #

Signature: _____
Authorized Firm Representative

Title: _____ Date: _____

**PREFERENTIAL BIDDER STATUS AFFIDAVIT FOR BIDS SUBMITTED IN ACCORDANCE WITH
NRS 338.0117 VALUED \$250,000 OR MORE**

Although Washoe County School District prefers this form is submitted with the bid response, this form may be submitted within two (2) hours of the bid opening.

Note: The Certificate of Eligibility for Preferential Bidder Status issued by the State Contractor’s Board must be submitted with the bid response.

I, _____ (“Affiant”), on behalf of _____ (“Contractor”), swear and affirm that in order to be in compliance with NRS 338.0117, and be eligible to receive a preference in bidding for Project No. _____, Project Name _____ (“Project”), certify that for the duration of the project, collectively, and not on any specific day:

(a) At least 50 percent of the workers employed on the public work, including, without limitation, any employees of the contractor, applicant or design-build team and of any subcontractor engaged on the public work, will hold a valid driver’s license or identification card issued by the Department of Motor Vehicles of the State of Nevada;

(b) All vehicles used primarily for the public work will be:

(1) Registered and partially apportioned to Nevada pursuant to the International Registration Plan, as adopted by the Department of Motor Vehicles pursuant to NRS 706.826; or

(2) Registered in this State;

(c) If applying to receive a preference in bidding pursuant to subsection 3 of NRS 338.1727 or subsection 2 of NRS 408.3886, at least 50 percent of the design professionals working on the public work, including, without limitation, employees of the design-build team and of any subcontractor or consultant engaged in the design of the public work, will have a valid driver’s license or identification card issued by the Department of Motor Vehicles of the State of Nevada; and

(d) The contractor, applicant or design-build team and any subcontractor engaged on the public work will maintain and make available for inspection within this State his or her records concerning payroll relating to the public work.

If the contractor fails to comply with any requirements of this Affidavit, a public body may recover, by civil action against the party responsible for a failure to comply with a requirement of this affidavit, a penalty as described below for a failure to comply with a requirement of this affidavit. If a public body recovers a penalty pursuant to this subsection, the public body shall report to the State Contractors’ Board the date of the failure to comply, the name of each entity which failed to comply and the cost of the contract to which the entity that failed to comply was a party. The Board shall maintain this information for not less than 6 years. Upon request, the Board shall provide this information to any public body or its authorized representative.

If a contractor, applicant or design-build team submits this affidavit, receives a preference in bidding described in this affidavit and is awarded the contract as a result of that preference, the contract between the contractor, applicant or design-build team and the public body, each contract between the contractor, applicant or design-build team and a subcontractor and each contract between a subcontractor and a lower tier subcontractor must provide that:

a) If a party to the contract causes the contractor, applicant or design-build team to fail to comply with a requirement of this affidavit, the party is liable to the public body for a penalty in the amount of 1 percent of the cost of the largest contract to which he or she is a party;

- b) The right to recover the amount determined pursuant to paragraph (a) by the public body pursuant to this affidavit may be enforced by the public body directly against the party that caused the failure to comply with a requirement of this affidavit; and
- c) No other party to the contract is liable to the public body for a penalty.

By: _____ Title: _____
 (Print Name of Affiant)

Signature of Affiant: _____ Date: _____

Signed and sworn to (or affirmed) before me on this _____ day of _____, 20____, by _____ (name of Affiant).

State of _____)
)ss. _____
 County of _____)

Notary Signature
 STAMP & SEAL

Proof of Authorization to Sign Affidavit

The person must establish his/her actual authority to act on behalf of the business organization. The individual must be the person indicated in the table below and provide written documentation clearly indicating the person’s position within that business organization. If the individual signing the Affidavit is an employee of the business organization, written documentation, on organization letterhead, clearly indicating the person’s authority to act on behalf of the business organization must be provided. The written documentation must be signed by the authorized person identified on the table.

If the individual making application for the business organization is not one of the persons identified in the table or an authorized employee, a valid power of attorney executed by an authorized person on behalf of the business organization must be provided. The power of attorney must be made not more than 90 days before the Affidavit is signed.

BUSINESS ENTITY	PERSON WHO HAS AUTHORITY TO COMPLETE AFFIDAVIT
Sole Proprietorship	Sole Proprietor
Partnership	A Partner
Corporation	1. Director, if Authorized 2. Executive Officer as indicated in the Article of Incorporation
Limited Liability Company	1. Member, if Member-Managed LLC 2. Manager, if Manager-Managed LLC

WASHOE COUNTY SCHOOL DISTRICT PUBLIC DISCLOSURE FORM

VENDOR/CONTRACTOR

THIS IS A REQUIRED FORM TO BE COMPLETED, SIGNED, AND SUBMITTED BY THE VENDOR/CONTRACTOR

VENDOR/CONTRACTOR (EMPLOYEE) FIRST/LAST NAME: _____

VENDOR/CONTRACTOR NAME: _____

I understand that per NRS 281A.020, a public office is a public trust and shall be held for the sole benefit of the people, and a public officer or employee must commit themselves to avoid conflicts between the private interests of the public officer or employee and those of the general public whom the public officer or employee serves.

Furthermore, I understand that pursuant to Washoe County School District (WCSD) Board of Trustees Policy 4505 and per NRS 281A.400, WCSD employees (as public officers) shall not seek and/or accept any gift, work/service, favor, employment, engagement, emolument, and/or economic opportunity, including, but not limited to, unlawful compensation, salary, retainer, augmentation, expense allowance, commission, personal profit, pecuniary interest in the course of performing WCSD duties. In addition, WCSD employees (as public officers) shall not use their positions to secure and/or grant unwarranted privileges, preferences, exemptions, and/or advantages for the public officer or employee with any business entity.

By signing this form, I certify and acknowledge that I am a duly authorized agent of the VENDOR/CONTRACTOR named above and that failure to disclose all facts relative to a conflict and/or potential conflict of interest (ethical standards) with regard to the specific solicitation, project, and/or contract to which the VENDOR/CONTRACTOR named above is submitting to WCSD may result in a rejection of said solicitation, project, and/or submission and/or termination of any resulting contract should the above-named VENDOR/CONTRACTOR be selected and/or awarded. Furthermore, I also certify that I have completed the following and have provided true and accurate information to the best of my knowledge:

- A. I certify that, to the best of my knowledge, **NO** current or former WCSD employees, officers, or trustees have a private pecuniary interest in the VENDOR/CONTRACTOR. **AGREE** **DISAGREE**

If you **DISAGREE** and cannot certify, then please explain:

- B. To the third degree of consanguinity (refer to the chart below), I have listed all of my and the principal(s) and key personnel of my organization's personal relationships, partnerships, correlations, and relatives (by blood and/or marriage) between WCSD, Officers of WCSD, key employees of WCSD, current and former WCSD Board of Trustees members and any other current and former WCSD personnel. **AGREE** **DISAGREE**

If you **DISAGREE** and cannot certify, then please explain:

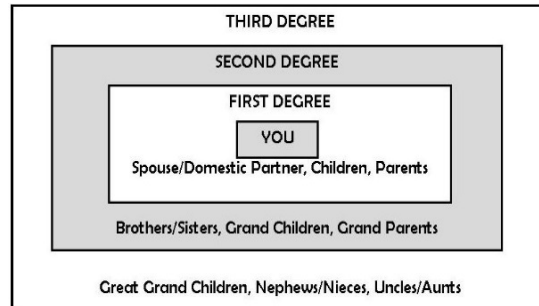

SIGNATURE: _____

DATE: _____

BID BOND

KNOW ALL PERSONS BY THESE PRESENTS, that we, the undersigned _____,
as Principal, and _____ as
Surety, are hereby held and firmly bound unto the Board of Trustees, Washoe County School
District, as Owner, in the sum of _____
_____ Dollars (\$_____)
for payment of which, well and truly to be made, we hereby jointly and severally bind ourselves,
our heirs, executors, administrators, successors, and assigns.

Signed this _____ day of _____, 20_____.

The condition of the above obligation is such that whereas the Principal has submitted to
the Board of Trustees, Washoe County School District, a certain bid, attached hereto and hereby
made a part hereof, to enter into a Contract in writing for: _____
_____.

NOW, THEREFORE, if said bid shall be rejected, or in the alternative, if said bid shall be
accepted and the Principal shall execute and deliver a Contract in the form of Contract attached
hereto (properly completed in accordance with said Bid) and shall furnish a Bond for its faithful
performance of said Contract, and a Bond for the payment of all persons performing labor or
furnishing materials in connection therewith, and shall in all other respects perform the contract
created by the acceptance of said Bid, then this obligation shall be void.

Otherwise, the same shall remain in force and effect, and the sum herein specified paid
over to the Owner; it being expressly understood and agreed that the liability of the Surety for
any and all claims hereunder shall, in no event, exceed the amount of this obligation as herein
stated.

The Surety, for value received, hereby stipulates and agrees that the obligations of said
Surety and its bond shall be in no way impaired or affected by an extension of the time within

which the Owner may accept such bid; and said Surety does hereby waive notice of any such extension.

IN WITNESS WHEREOF, the Principal and the Surety have hereunto set their hands and seals, and such of them as are corporations have caused their corporate seals to be hereto affixed and these presents to be signed by their officers, the day and year first set forth above.

Principal

(Seal)

By: _____

Surety

(Seal)

By: _____

Address:

Phone: _____

LABOR AND MATERIALS BOND

KNOW ALL PERSONS BY THESE PRESENTS: That WHEREAS, the Board of Trustees, Washoe County School District in the State of Nevada has awarded to _____, hereinafter designated as "Principal", a contract dated _____, for _____ a copy of which contract is attached hereto and by reference made a part hereof, and hereinafter referred to as the "Contract".

And WHEREAS, said Principal is required under the terms of said Contract and by law under the provisions of N.R.S. 339 to furnish a Bond for the labor and materials used in said Contract;

NOW, THEREFORE, we, the Principal, and _____, as Surety, are held and firmly bound unto the Board of Trustees, Washoe County School District in the State of Nevada in the sum of _____ Dollars (\$_____), lawful money of the United States, being not less than one hundred percent (100%) of the estimated Contract cost of the work, for the payment of which sum will and truly to be made, we bind ourselves, our heirs, executors, administrators, and successors, jointly and severally, firmly by these presents.

THE CONDITION OF THIS OBLIGATION IS SUCH, that if the above-bounden Principal, or its heirs, executors, administrators, successors or assigns shall fail to pay for any materials, provisions, supplies implements or machinery used in, upon, for, or about the performance of the work contracted to be done, or for any work or labor thereon of any kind, or for amounts due under the Unemployment Compensation Law with respect to such work or labor, as required by the Provisions of N.R.S. 339, the Surety hereon will pay for the same within thirty (30) calendar days an amount not exceeding the sum specified in this bond, and the above obligation shall then be null and void. Otherwise, it shall remain in full force and virtue.

THE SURETY, for value received, hereby stipulates and agrees that no change, extension of time, alteration or addition to the terms of the Contract, or to the work to be

performed thereunder, or to the specifications accompanying the same, shall in any way affect its obligations on this bond, and it does hereby waive notice of any such change, extension of time, alteration or addition to the terms of the Contract or to the work, or to the specifications.

And the said Surety, for value received, further stipulates and agrees that should the Board of Trustees, Washoe County School District, or other obligees, incur attorney's fees or other expenses for the enforcement of the Contract or this bond, the same shall be paid by the Surety to the contracting body, subcontractors, workmen laborers, mechanics and furnishers of material as their interests may appear.

IN WITNESS WHEREOF, the above-bounded parties have executed this instrument under their seals this _____ day of _____, 20____, the name and corporate seal of each corporate party being hereto affixed and these presents duly signed by its undersigned representative, pursuant to authority of its governing body.

Principal

(Seal)

By: _____

Surety

(Seal)

By: _____

Address:

Phone: _____

PERFORMANCE BOND

KNOW ALL PERSONS BY THESE PRESENTS: That WHEREAS, the Board of Trustees, Washoe County School District in the State of Nevada has awarded to _____, Hereinafter designated as "Principal": a contract dated _____, for _____

_____ a copy of which contract is attached hereto and by reference made a part hereof, and hereinafter referred to as the "Contract".

And WHEREAS, said Principal is required under the terms of said Contract and by law under the provisions of N.R.S. 339 to furnish a Bond for the faithful performance of said Contract;

NOW, THEREFORE, we, the Principal, and _____, as Surety, are held and firmly bound unto the Board of Trustees, Washoe County School District in the State of Nevada in the sum of _____ Dollars (\$_____), lawful money of the United States, being no less than one hundred per cent (100%) of the estimated Contract Cost of the work, for the payment of which sum well and truly to be made, we bind ourselves, our heirs, executors, administrators, and successors, jointly and severally, firmly by these presents.

THE CONDITION OF THIS OBLIGATION IS SUCH, that if the above bounden Principal, or its heirs, executors, administrators, successors, or assigns, shall in all things stand to and abide by and well and truly keep the faithfully perform the covenants, conditions, and agreements in the Contract and any alterations made as therein provided, on his or its part to be kept and performed at the respects according to their true intent and meaning; and shall indemnify and save harmless the Board of Trustees, Washoe County School District in the State of Nevada, its officers and agents, as therein stipulated; then this obligation shall become null and void. Otherwise, it shall be and remain in full force and virtue.

As a condition precedent to the satisfactory completion of the Contract, the above obligation shall hold good for a period of one (1) year after completion and acceptance of the work done, during which time if the above-bounden Principal, his or its heirs, executors, administrators, successors, or assigns shall fail to make full, complete, and satisfactory repair and replacements or totally protect the Board of Trustees, Washoe County School District in the State of Nevada from loss or damage made evident during said period of one (1) year from the date of acceptance of said work, and resulting from or caused by defective materials or faulty workmanship in the prosecution of the work done, the above obligation in the said sum of _____ Dollars (\$_____)

shall remain in full force and virtue; otherwise, the above obligation shall be void.

THE SURETY, for value received, hereby stipulates and agrees that no change, extension of time, alteration or addition to the terms of the Contract, or to the work to be performed thereunder, or to the specifications accompanying the same, shall in anyway affect its obligations on this bond, and it does hereby waive notice of any such change, extension of time, alteration or addition to the terms of the Contract, or to the work, or to the specifications.

And the said Surety, for value received, further stipulates and agrees that should the Board of Trustees, Washoe County School District, incur attorney's fees or other expenses for the enforcement of the Contract or his/her bond, the same shall be paid by the Surety to the Board of Trustees, Washoe County School District.

IN WITNESS WHEREOF, the above-bounden parties have executed this instrument under their seals this _____ day of _____, 20____, the name and corporate seal of each corporate party being hereto affixed and these presents duly signed by its undersigned representative, pursuant to authority of its governing body.

Principal

(Seal)

By: _____

Surety

By: _____

Address:

(Seal)

Phone: _____

SECTION 01001 – CONSTRUCTION PROCEDURES FOR EXISTING SCHOOL SITES

PART 1 – GENERAL

1.1 DESCRIPTION

- A. All work activities under this contract shall be coordinated with the requirements of the Washoe County School District's (WCSD) Facilities Management Department. WCSD shall be contacted prior to any service shutdown and advised when such shutdown shall be commenced. All materials and equipment shall be stored in spaces assigned by WCSD. The Contractor will be required to maintain a neat and orderly operation and to limit or keep noise and nuisance to a minimum.
- B. WCSD reserves the right to remove any person from the property for the safety and security of the facility

1.2 GENERAL REQUIREMENTS FOR WORK INSIDE THE EXISTING PERIMETER AND EXISTING BUILDINGS

- A. It is a felony to transport any alcoholic beverages, drugs, weapons or ammunition of any kind on WCSD property
- B. Any contact or conversation with students is prohibited.
- C. Smoking is prohibited on all WCSD property.
- D. Working hours inside the existing perimeter and existing building will be coordinated with WCSD.
- E. Storage of materials inside the existing perimeter and buildings will be coordinated with WCSD Facilities Management Department.
- F. Construction operations shall be confined to the areas permitted under the contract. Areas beyond indicated work areas are not to be disturbed. Conform to site rules and regulations affecting the work.
- G. Keep driveways and entrances serving the premises clear and available at all times. Do not use these areas for parking or storage of materials.
- H. Passenger cars, trucks and motorized construction equipment, when parked and unattended, shall be locked and the ignition key removed. Do not leave any such vehicle with the motor running.
- I. Limitations on site usage, as well as specific requirements that impact site utilization are indicated on the drawings and any other contract documents. Allocate available space equitably among sub-contractors needing both access and space so as to produce the best overall efficiency. Schedule deliveries to minimize space and time requirements for storage of materials and equipment.

SECTION 01001 – CONSTRUCTION PROCEDURES FOR EXISTING SCHOOL SITES

J. All refuse will be removed daily.

PART 2 – PRODUCTS (Not Applicable)

PART 3 – EXECUTION (Not Applicable)

END OF SECTION 01001

SECTION 01010 - SUMMARY OF WORK

PART 1 – GENERAL

1.1 RELATED DOCUMENTS

- A. Drawings and general provisions of the Contract, including all contract documents and addendums associated with this project shall apply to this section.

1.2 PROJECT DESCRIPTION

- A. Project to entail work as described in scope of work.
- B. The project shall consist of all on and off-site improvements, as shown in the contract documents.

1.3 CONTRACTOR USE OF PREMISES

- A. General: During the construction period the Contractor shall have full use of the premises (construction area) for construction operations. The Contractor's use of the premises (construction area) is limited only by the Owner's right to perform construction operations with its own forces or to employ separate contractors on portions of project.
- B. Keep driveways and entrances serving the premises clear and available to the Owner and the Owner's employees at all times. Do not use these areas for parking or storage of materials. Schedule deliveries to minimize space and time requirements for storage of materials and equipment site.

1.4 OWNER OCCUPANCY

- A. Partial Owner Occupancy: The Owner reserves the right to occupy and to place and install equipment in completed areas of the building, prior to substantial completion provided that such occupancy does not interfere with completion of the work. Such placing of equipment and partial occupancy shall not constitute acceptance of the total work.

1.5 OWNER FURNISHED ITEMS

- A. The Owner will provide certain pieces of equipment and accessories that are to be installed and connected by the Contractor.
 - 1. The Owner will arrange and pay for delivery of Owner furnished items in accordance with the Contractor's construction schedule, and will inspect deliveries for damage.
 - 2. If Owner furnished items are damaged, defective or missing, the Owner will arrange for replacement. The Owner will also arrange for manufacturer's field

SECTION 01010 - SUMMARY OF WORK

services and the delivery of manufacturer's warranties and bonds to the Contractor.

3. The Contractor is responsible for designating the delivery dates of Owner furnished items in the Contractor's construction schedule and for receiving, unloading and handling Owner furnished items at the site. The Contractor is responsible for protecting Owner furnished items from damage, including damage from exposure to the elements, and to repair or replace items damaged as a result of the Contractor's operations.
4. Owner furnished and Contractor installed and connected equipment shall be as indicated in the contract documents.

END OF SECTION 01010

SECTION 01015 – SCHEDULE OF DRAWINGS

- C0.1 – Civil Title Sheet
- C1.1 – Civil Demo Plan
- C1.2 – Civil Demo Plan
- C2.1 – Civil Site Plan
- C2.2 – Civil Site Plan
- C3.1 – Civil Grading Plan
- C3.2 – Civil Grading Plan
- C4.1 – Civil Detail Sheet

SECTION 01020 – PERSONNEL SAFETY CHECK APPLICATION

PART 1 -GENERAL

1.1 RELATED DOCUMENTS

- A. General provisions of the Contract, including General and Supplementary Conditions and other Division 1 Specification Sections, apply to this section.

1.2 SUMMARY

- A. This section includes administrative and procedural requirements for submittals required for performance of the work for all entities/individuals including, but not limited to, the following:
 - 1. General Contractor
 - 2. Sub-Contractor
 - 3. Sub-Contractor of Sub-Contractor
 - 4. Quality Control Personnel
 - 5. Special Inspection Personnel
 - 6. Security Personnel
 - 7. Consultant Personnel
- B. Administrative Submittals: Refer to other Division 1 sections and other Contract Documents for requirements for administrative submittals.

1.3 SUBMITTAL PROCEDURES

A. Required Submittals

- 1. Each company, engaged on a project, shall report to the Washoe County School District all required certifications for every employee who will be on a Washoe County School District site. This includes all personnel whom the Contractor engages for work on the project site as defined in 1.2 (A). This information must be submitted within twenty-one (21) calendar days prior to commencement of work by the Contractor, and any sub-contractor, regardless of tier. Such submittals required include:
 - a. Certification by Company Regarding Personnel Safety Check Application.

PART 2- PRODUCTS (Not Applicable)

PART 3- EXECUTION (Not Applicable)

SECTION 01020 – PERSONNEL SAFETY CHECK APPLICATION

**CERTIFICATION BY COMPANY REGARDING
PERSONNEL SAFETY CHECK APPLICATION**

Washoe County School District – Capital Improvement Projects

I certify on behalf of the company/firm named below that adequate background check procedures have been or will be performed for all employees that will work on Washoe County School District project _____ (Project Name) regarding _____ (Company/Firm Name) to determine that their employees meet the qualifications required by the Washoe County School District.

With this certification, I confirm that:

- All employees working on a Washoe County School District project shall not have been arrested, convicted, pled guilty, or pled nolo contendere for any offenses related to:
 - Sexual assault or sexual activities with a minor
 - Child abuse
 - Felony drug possession
 - Felony weapons possession
- All employees working on a Washoe County School District project shall not:
 - Have any active Wants/Warrants
 - Is a Registered Sex Offender
 - Is on a Terrorist list.

I understand that the Washoe County School District maintains the right to remove any individuals from the project who do not comply with the above requirements.

I certify the information provided on this application is true, complete, and correct to the best of my knowledge and belief and is provided in good faith. I understand that a knowing and willful false statement on this application can be an automatic disqualification.

I hereby release, discharge, exonerate and hold harmless the Washoe County School District, its agents and representatives and persons furnishing information from any and all liability arising out of the disseminating and inspection of my records.

Company/Firm Name

Name of Executive Officer

Title

Signature

Date

SECTION 01027 – APPLICATIONS FOR PAYMENT

PART 1 - GENERAL

1.1 RELATED DOCUMENTS

- A. Drawings and general provisions of the Contract, including all bid documents and addendums associated with this project shall apply to this section.

1.2 SUMMARY

- A. This section specifies administrative and procedural requirements governing the Contractor's Applications for Payment.
- B. Related Sections: The following sections contain requirements that relate to this section.
 - 1. Schedules: The Contractor's Construction Schedule and Submittal Schedule are specified in SECTION 01300 - SUBMITTALS.

1.3 SCHEDULE OF VALUES

- A. Coordination: Coordinate preparation of the Schedule of Values with preparation of the Contractor's Construction Schedule.
 - 1. Correlate line items in the Schedule of Values with other required administrative schedules and forms, including:
 - a. Contractor's Construction Schedule
 - b. Application for Payment forms, including continuation sheets
 - c. List of all tier Sub-Contractors
 - d. List of products
 - e. List of principal suppliers and fabricators
 - f. Schedule of Submittals
 - g. Schedule of Allowances
 - h. Schedule of Alternates
 - 2. Submit the Schedule of Values to the Architect at the earliest possible date but no later than seven (7) calendar days before the date scheduled for submittal of the initial Application for Payment.
 - 3. Sub-schedules: Where Work is separated into phases requiring separately phased payments, provide sub-schedules showing values correlated with each phase of payment.
- B. Format and Content: Use the Project Manual Table of Contents as a guide to establish the format for the Schedule of Values. Provide at least one line item for

SECTION 01027 – APPLICATIONS FOR PAYMENT

each Specification Section by site improvements, by each individual building new or addition construction, and by each individual building remodel or revitalization.

1. Arrange Schedule with subtotals for the following:
 - a. General Conditions
 - b. Fee including overhead, proffit, all insurances
 - c. Site Improvements
 - d. Each individual building new or addition;
 - e. Each individual building remodel or revitalization
2. Identification: Include the following Project identification on the Schedule of Values:
 - a. Project name and location
 - b. Name of the Architect
 - c. Project Number
 - d. Contractor's name and address
 - e. Date of submittal
3. Arrange the Schedule of Values in tabular form with separate columns to indicate the following for each item listed:
 - a. Related Specification Section or Division including general conditions broken down catagorically.
 - b. Description of Work
 - c. Name of Sub-Contractor
 - d. Name of manufacturer or fabricator
 - e. Generic Name of supplier
 - f. Change Orders (numbers) that affect value
 - g. Dollar value
 1. Percentage of Contract Sum to nearest one-hundredth percent, adjusted to total 100 percent.
4. Provide a breakdown of the Contract Sum in sufficient detail to facilitate continued evaluation of Application for Payment and progress reports. Coordinate with the Project Manual Table of Contents. Break principal subcontract amounts down into several line items. Include a line item for Force Accounts and unit price items, as applicable.
5. The total shall equal the Contract Sum.
6. For each part of the work where an Application for Payment may include materials or equipment, purchased or fabricated and stored on or off-site, provide separate line items on the Schedule of Values for cost of those materials.

SECTION 01027 – APPLICATIONS FOR PAYMENT

- a. If the Contractor is requesting payment for materials or equipment that are stored off-site, those materials must be stored in a bonded and insured third party warehouse, and they must be segregated from other stored materials and they shall be identified according to project name, material and/or equipment description, and quantity. These materials must be observed in their stored condition by either the Architect or the Owner's representative prior to approval of the Application for Payment. In lieu of bond for stored materials offsite the contractor/subcontractor may provide an appropriate insurance policy approved by the owner to provide for the full replacement cost coverage for all materials stored. Any coverage for materials or equipment stored off-site shall include Owner as loss payee with respect to its interests. These materials must be observed in their stored condition by either the Architect or the Owner's representatives prior to approval of the Application for Payment.
 - b. All stored material payment requests shall include material supplier invoicing and shall not include labor or delivery costs.
7. Temporary facilities and other major cost items that are not direct cost of actual work-in-place shall be shown as separate line items in the Schedule of Values
- a. General Conditions shall be broken down by major cost items and categories including breakout of labor and material.
 - b. General Conditions performed by subcontract work shall be broken down to individual categories on the schedule of values. No internal changes to subcontracts shall be allowed without formal Change Order Documentation and reflected on the schedule of values.
8. Schedule Updating: Update and resubmit the Schedule of Values prior to the next Application for Payment when Change Orders or Construction Change Directives result in a change in the Contract Sum.

1.4 APPLICATIONS FOR PAYMENT

- A. Each Application for Payment shall be consistent with previous applications and payments as certified by the Architect and Owner's representative and paid for by the Owner.
 1. The initial Application for Payment, the Application for Payment at time of Substantial Completion, and the final Application for Payment involve additional requirements
- C. Each application for payment shall include sufficient documentation to substantiate completed work including but not limited to: subcontractor invoicing, all tiers; general conditions cost breakdown, etc.

SECTION 01027 – APPLICATIONS FOR PAYMENT

- C. Payment Application Times: The date for each progress payment is as indicated in the Contract. The period covered by each Application for Payment is the period indicated in the Contract.
- D. Payment Application Forms: Use Washoe County School District Certificate for Payment form only. This form is available in both hard copy format or electronic format.
- E. Application Preparation: Complete every entry on the form. The execution of this form shall be by a person authorized to sign legal documents on behalf of the Contractor. The Owner will return incomplete applications without action.
 - 1. Entries shall match data on the Schedule of Values and the Contractor's Construction Schedule. Use updated schedules if revisions were made.
 - 2. Include amounts of Change Orders and Construction Change Directives issued prior to the last day of the construction period covered by the application.
- F. Pre-Approval of Application: Percentages of completed work are to be verified by the Owner's Representative and Architect prior to transmittal to the Architect.
 - 1. It shall be established at the Pre-Construction meeting the protocols that are acceptable to each party for the review of payment application percentages.
- G. Record Drawings and Record Specifications: Prior to transmittal of the Application for Payment, Record Drawings and Record Specifications must be reviewed and approved by the Owner's Representative and Architect.
 - 1. It shall be established at the Pre-Construction meeting the protocols that are acceptable to each party for the review of Record Drawings and Specifications.
- H. Transmittal: Submit one (1) signed original copy of each Application for Payment to the Architect by a method ensuring receipt within twenty-four (24) hours. The submitted copy shall be complete, including waivers of lien and similar attachments, when required.
 - 1. Transmit each copy with a transmittal form listing attachments and recording appropriate information related to the application, in a manner acceptable to the Architect.
 - 2. Obtain Owner's Representative's initials as established during the Pre-Construction meeting and in sub-section 1.4, items E & F above.
- I. Waivers of Mechanic's Lien: With each Application for Payment, submit conditional waivers of mechanic's lien from every entity who is lawfully entitled to file a

SECTION 01027 – APPLICATIONS FOR PAYMENT

mechanic's lien arising out of the Contract and related to the work covered by the payment.

1. Waiver Forms: Submit waivers of lien on forms, and executed in a manner, acceptable to the Owner.
- J. Initial Application for Payment: Administrative actions and submittals, that must precede or coincide with submittal of the first Application for Payment, include the following:
1. List of Sub-Contractors (all tiers)
 2. List of principal suppliers and fabricators
 3. Schedule of Values
 4. Contractor's Construction Schedule
 5. Schedule of principal products
 6. Submittal Schedule
 7. List of Contractor's staff assignments
 8. List of Contractor's principal consultants
 9. Copies of Building Permits
 10. Copies of authorizations and licenses from governing authorities for performance of the work
 11. Initial Progress Report
 12. Report of Pre-Construction meeting
 13. Data needed to acquire the Owner's insurance
 14. Initial settlement survey and damage report, if required, (existing facility condition)
 15. Record Drawings *
 16. Record Specifications*

* Record Drawings and Specifications must be reviewed and approved by the Owner's Representative prior to the Application for Payment.

SECTION 01027 – APPLICATIONS FOR PAYMENT

K. Continuing Application for Payments: Administrative actions and submittals, that must precede or coincide with submittal of the Application for Payment, include the following:

1. Updated Contractor's Construction Schedule
2. Progress report
3. Record Drawings*
4. Record Specifications*

*Record Drawings and Specifications must be reviewed and approved by the Owner's Representative prior to the Application for Payment.

L. Application for Payment at Substantial Completion: Following issuance of the Certificate of Substantial Completion, submit an Application for Payment.

1. This application shall reflect Certificates of Partial Substantial Completion issued previously for Owner occupancy of designated portions of the work.
2. Administrative actions and submittals that shall precede or coincide with this application include:
 - a. Occupancy permits and similar approvals
 - b. Changeover information related to Owner's occupancy, use, operation, and maintenance
 - c. Final cleaning
 - d. Application for reduction of retainage and consent of surety
 - e. Advice on shifting insurance coverages
 - f. List of incomplete work, recognized as exceptions to Architect's Certificate of Substantial Completion
 - g. Record Drawings*
 - h. Record Specifications*
 - i. Meter Readings
 - j. Change of door locks to Owner's access

*Record Drawings and Specifications must be reviewed and approved by the Owner's Representative prior to the Application for Payment.

M. Final Payment Application: Administrative actions and submittals that must precede or coincide with submittal of the final Application for Payment include the following:

1. Completion of project closeout requirements
2. Completion of items specified for completion after Substantial Completion

SECTION 01027 – APPLICATIONS FOR PAYMENT

3. Ensure that unsettled claims will be settled
4. Ensure that incomplete work is not accepted and will be completed without undue delay
5. Completion and final reporting of all prevailing wage and apprentice utilization including unsettled prevailing wage and apprentice utilization claims
6. Transmittal of required project construction records to the Owner
7. Proof that taxes, fees, and similar obligations were paid
8. Removal of temporary facilities and services
9. Removal of surplus materials, rubbish, and similar elements
10. Certified property survey
11. Warranties (Guarantees) and Maintenance Agreements
12. Test/adjust/balance records
13. Operation and Maintenance Manuals
14. Startup performance reports
15. Final progress photographs

PART 2 - PRODUCTS (Not Applicable)

PART 3 - EXECUTION (Not Applicable)

END OF SECTION 01027

SECTION 01035 - MODIFICATION PROCEDURES

PART 1 – GENERAL

1.1 RELATED DOCUMENTS

- A. Drawings and general provisions of the Contract, including all bid documents and addendums associated with this project shall apply to this section.

1.2 SUMMARY

- A. This section specifies administrative and procedural requirements for handling and processing contract modifications.
- B. Related Sections: The following sections contain requirements that relate to this Section:
 - 1. Division 1 SECTION 01300 – SUBMITTALS for requirements for the Contractor's Construction Schedule.
 - 2. Division 1 SECTION 01027 – APPLICATIONS FOR PAYMENT for administrative procedures governing Applications for Payment.
 - 3. Division 1 SECTION 01631 – SUBSTITUTIONS for administrative procedures for handling requests for substitutions made after award of the Contract.

1.3 MINOR CHANGES IN THE WORK

- A. The Architect will issue supplemental instructions authorizing minor changes in the work, not involving adjustment to the contract sum or contract time, as an Architect's Supplemental Instruction.

1.4 CHANGE ORDER PROPOSAL REQUESTS

- A. Owner-Initiated Proposal Requests: The Architect will issue a detailed description of proposed changes in the work that will require adjustment to the contract sum or contract time. If necessary, the description will include supplemental or revised drawings and specifications.
 - 1. Proposal requests issued by the Architect are for information only. Do not consider them as an instruction either to stop work in progress or to execute the proposed change.
 - 2. Within fourteen (14) working days of receipt of a proposal request, submit an estimate of cost necessary to execute the change to the Architect for the Owner's review.

SECTION 01035 - MODIFICATION PROCEDURES

- a. Include a list of quantities of products required and unit costs, with the total amount of purchases to be made. Where requested, furnish survey data to substantiate quantities.
 - b. Indicate applicable taxes, delivery charges, equipment rental and amounts of trade discounts.
 - c. Include a statement indicating the effect the proposed change in the work will have on the contract time.
 - d. Include all subcontractor and contractor overhead and profit per contract documents.
- B. Contractor-Initiated Proposals: When latent or unforeseen conditions require modifications to the Contract, the Contractor may propose changes by submitting a request for a change to the Architect.
1. Include a statement outlining the reasons for the change and the effect of the change on the work. Provide a complete description of the proposed change. Indicate the effect of the proposed change on the contract sum and contract time.
 2. Include a list of quantities of products required and unit costs, with the total amount of purchases to be made. Where requested, furnish survey data to substantiate quantities.
 3. Indicate applicable taxes, delivery charges, equipment rental, and amounts of trade discounts.
 4. Comply with requirements in SECTION 01631 – SUBSTITUTIONS if the proposed change requires substitution of one product or system for a product or system specified.
 5. Include a list of all associated cost that would be incurred, including subcontractor and contractor overhead and profit per contract documents.
- C. The Contractor shall prepare his response in accordance with the requirements set forth in the General Conditions.
- D. Proposal Request Form: Use AIA Document G709-2001 for Change Order Proposal Requests or Change Order Request Form (CP-F107).

1.5 CONSTRUCTION CHANGE DIRECTIVE

- A. Construction Change Directive: When the Owner and the Contractor disagree on the terms of a Proposal Request, the Owner and Architect may issue a Construction

SECTION 01035 - MODIFICATION PROCEDURES

Change Directive. The Construction Change Directive instructs the Contractor to proceed with a change in the work, for subsequent inclusion in a Change Order. The Construction Change Directive will be approved upon email confirmation from the Owner.

1. The Construction Change Directive contains a complete description of the change in the work. It also designates the method to be followed to determine change in the contract sum or contract time.
- B. Documentation: Maintain detailed records on a time and material basis of work required by the Construction Change Directive.
1. After completion of the change, submit an itemized account and supporting data necessary to substantiate cost and time adjustments to the Contract.
- C. Notification: Contractor shall notify Owner prior to any "Not to Exceed" items being over run. Additional Construction Change Directive may be required for over run work.

1.6 CHANGE ORDER PROCEDURES

- A. Upon the Owner's approval of a Proposal Request, the Architect will issue a Change Order for signatures of the Owner and the Contractor on AIA Form G701-2000/2001 or WCSD's Change Order Form (CP-F107).

PART 2 - PRODUCTS (Not Applicable)

PART 3 - EXECUTION (Not Applicable)

END OF SECTION 01035

SECTION 01035 - MODIFICATION PROCEDURES

**ARCHITECT / OWNER
SAMPLE PRICE REQUEST**

Date: _____ Price Request # _____

Contractor: _____

Bid/Quote #: _____

Project: _____

Please submit a Price Quotation for the following changes being considered. Quote the change within fourteen (14) calendar days - ADD or DEDUCT - in the Contract Sum and any change in the Contract Time. Also, please state how long the price quoted is effective before job conditions warrant an increase in price. This is NOT authorization to proceed with this work.

REFERENCE: _____

CHANGE: _____

REQUESTED BY: _____

REASON: _____

SECTION 01035 - MODIFICATION PROCEDURES

**CONTRACTOR / OWNER
SAMPLE CHANGE ORDER REQUEST**

Date: _____ Price Request # _____

Contractor: _____

Bid/Quote #: _____

Project: _____

Please submit a Price Quotation for the following changes being considered. Quote the change within five (14) calendar days - ADD or DEDUCT - in the Contract Sum and any change in the Contract Time. Also, please state how long the price quoted is effective before job conditions warrant an increase in price. This is NOT authorization to proceed with this work.

REFERENCE: _____

CHANGE: _____

REQUESTED BY: _____

REASON: _____

SECTION 01035 - MODIFICATION PROCEDURES

SAMPLE CLARIFICATION

DATE: _____

TO: _____

FROM: _____

SUBJECT: _____

REFERENCE: _____

CLARIFICATION: _____

THIS INFORMATION IS PROVIDED FOR CLARIFICATION ONLY AND DOES NOT INVOLVE ANY CHANGE IN CONTRACT PRICE OR TIME.

SIGNATURE: _____

TITLE: _____

DATE: _____ CLAR. NO.: _____

SECTION 01035 - MODIFICATION PROCEDURES

SAMPLE REQUEST FOR INFORMATION

DATE: _____

TO: _____

FROM: _____

SUBJECT: _____

REFERENCE:

Specification Section: _____ Paragraph: _____

Drawing Number: _____ Details: _____

INFORMATION REQUIRED: _____

SIGNATURE: _____

TITLE: _____

DATE: _____

REPLY TO ABOVE RFI: _____

THIS INFORMATION IS PROVIDED FOR CLARIFICATION ONLY AND DOES NOT INVOLVE ANY CHANGE IN CONTRACT PRICE OR TIME.

SIGNATURE: _____

TITLE: _____

DATE: _____ CLAR. NO.: _____

SECTION 01040 – COORDINATION

PART 1 – GENERAL

1.1 RELATED DOCUMENTS

- A. Drawings and general provisions of the Contract, including all bid documents and addendums associated with this project shall apply to this section.

1.2 SUMMARY

- A. This section includes administrative and supervisory requirements necessary for coordinating construction operations including, but not necessarily limited to, the following:

1. General project coordination procedures
2. Conservation
3. Coordination Drawings
4. Administrative and supervisory personnel
5. Cleaning and protection

- B. Related Sections: The following sections contain requirements that relate to this Section:

1. Division 1 Section 01050 – FIELD ENGINEERING specifies procedures for field engineering services, including establishment of benchmarks and control points.
2. Division 1 Section 01200 – PROJECT MEETING for progress meetings, coordination meetings, and pre-installation conferences.
3. Division 1 Section 01300 – SUBMITTALS for preparing and submitting the Contractor's construction schedule.
4. Division 1 Section 01600 – MATERIALS AND EQUIPMENT for coordinating general installation.
5. Division 1 Section 01700 – CONTRACT CLOSEOUT for coordinating contract closeout.

1.3 COORDINATION

- A. Coordinate construction operations included in various sections of these Specifications to assure efficient and orderly installation of each part of the work.

SECTION 01040 – COORDINATION

Coordinate construction operations included under different sections that depend on each other for proper installation, connection, and operation.

1. Schedule construction operations in the sequence required to obtain the best results where installation of one part of the work depends on installation of other components, before or after its own installation.
 2. Coordinate installation of different components to assure maximum accessibility for required maintenance, service, and repair.
 3. Make provisions to accommodate items scheduled for later installation.
- B. Where necessary, prepare memoranda for distribution to each party involved, outlining special procedures required for coordination, include such items as required notices, reports, and attendance at meetings.
1. Prepare similar memoranda for the Owner and separate contractors where coordination of their work is required.
- C. Administrative Procedures: Coordinate scheduling and timing of required administrative procedures with other construction activities to avoid conflicts and assure orderly progress of the work. Such administrative activities include, but are not limited to, the following:
1. Preparation of schedules
 2. Installation and removal of temporary facilities
 3. Delivery and processing of submittals
 4. Progress meetings
 5. Project closeout activities
- D. Conservation: Coordinate construction operations to assure that operations are carried out with consideration given to conservation of energy, water, and materials.
1. Salvage materials and equipment involved in performance of, but not actually incorporated in, the work.
- E. Coordinate the installation of all motor starters. General Contractor is responsible for costs associated with supplying and installing all required motor starters.

SECTION 01040 – COORDINATION

- F. Dimensions: The Structural drawings are to be used in conjunction with the Architectural, Mechanical and Electrical drawings. Primary structural elements are dimensioned on the structural plans and details. Not all secondary dimensions are shown, such as exact door and window locations, wall configurations, slab slopes, depressions, curbs, etc. Coordination of the structure of the dimensions as shown on the drawings and architectural items to be embedded into, or attached to the structure, is the responsibility of the Contractor. Any dimensions discrepancies between the Architectural, Civil Structural, Mechanical and Electrical drawings shall be reported to the Owner's Representative and Architect before proceeding with the work.
- G. Intent of Drawings:
1. The work of the Contractor and subcontractor shall conform to the intent of the architectural and coordination drawings as reviewed by the Architect. Drawings are partly diagrammatic and do not intend to show in details all features of work. The Contractor shall carefully review the work to be performed by other trades, compare related drawings and shall thoroughly understand the building conditions affecting their work.
 2. All changes required in the work caused by failure to do so shall be at no expense to the Owner.
- H. Interfaces and Right-of-Way:
1. Make proper provisions to avoid interfaces.
 2. Where conflicts occur, architectural and structural has right-of-way over mechanical and electrical work; concealed mechanical work has right-of-way over concealed electrical work; exposed electrical fixtures have right-of-way over mechanical fixtures.
 3. Submit conflicts which cannot be resolved by right-of-way to the Owner for direction.
 4. Submit reflected ceiling coordination plans showing work by all applicable trades for review and approval by the Architect.
- I. Masonry Wall Coordination Drawings:
1. Contractor shall be responsible for providing masonry wall coordination drawings for all concrete masonry unit walls. Drawings shall consist of wall elevations drawn to scale at not less than $\frac{1}{4}'' = 1'0''$.
 2. Wall elevations shall include dimensioned sizes and locations for all door, window and mechanical openings and penetrations, beam and joist

SECTION 01040 – COORDINATION

bearing pockets, ledger angles, embedded plate connections, and anchor bolts. All miscellaneous steel to be embedded in the masonry unit wall shall be referenced by show drawing mark number or structural detail number.

3. Masonry wall coordination drawings shall be reviewed and approved by interfacing trades prior to submittal to the Architect. Shop drawings for masonry reinforcement shall be an 'overlay' of the masonry wall coordination drawings. Detail, fabricate and place per ACI 315. Reinforcing shop drawings elevations shall show all vertical and horizontal reinforcing layouts; special reinforcement at lintels and jams at doors, windows, mechanical openings and as called out on Structural drawings.

1.4 SUBMITTALS

- A. Coordination Drawings: Prepare coordination drawings where careful coordination is needed for installation of products and materials fabricated by separate entities. Prepare coordination drawings where limited space availability necessitates maximum utilization of space of efficient installation of different components.

1. Show the relationship of components shown on separate Shop drawings.
2. Indicate required installation sequences.
3. Comply with requirements contained in Section 01300 - SUBMITTALS.

- B. Staff Names: Within 15 days of commencement of construction operations, submit a list of the Contractor's principal staff assignments, including the Superintendent and other personnel in attendance at the project site. Identify individuals and their duties and responsibilities. List their addresses and telephone numbers.

1. Post copies of the list in the Project Meeting Room, the temporary field office and each temporary telephone.

PART 2 – PRODUCTS (Not Applicable)

PART 3 – EXECUTION

3.1 GENERAL COORDINATION PROVISIONS

- A. Inspection of Conditions: Require the Installer of each major component to inspect both the substrate and conditions under which work is to be performed. Do not proceed until unsatisfactory conditions have been corrected in an acceptable manner.

SECTION 01040 – COORDINATION

- B. Coordinate temporary enclosures with required inspections and tests to minimize the necessity of uncovering completed construction for that purpose.

3.2 CLEANING AND PROTECTION

- A. Clean and protect construction in progress and adjoining materials in place, during handling and installation. Apply protective covering where required to assure protection from damage or deterioration at Substantial Completion.
- B. Clean and provide maintenance on completed construction as frequently as necessary through the remainder of the construction period. Adjust and lubricate operable components to assure operability without damaging effects.
- C. Limiting Exposures: Supervise construction operations to assure that no part of the construction completed or in progress, is subject to harmful, dangerous, damaging, or otherwise deleterious exposure during the construction period. Where applicable, such exposures include, but are not limited to, the following:
 - 1. Excessive static or dynamic loading
 - 2. Excessive internal or external pressures
 - 3. Excessively high or low temperatures
 - 4. Thermal shock
 - 5. Excessively high or low humidity
 - 6. Air contamination or pollution
 - 7. Water or ice
 - 8. Solvents
 - 9. Chemicals
 - 10. Light
 - 11. Radiation
 - 12. Puncture
 - 13. Abrasion
 - 14. Heavy traffic
 - 15. Soiling, staining and corrosion
 - 16. Bacteria
 - 17. Rodent and insect infestation
 - 18. Combustion
 - 19. Electrical current
 - 20. High-speed operation
 - 21. Improper lubrication
 - 22. Unusual wear or other misuse
 - 23. Contact between incompatible materials
 - 24. Destructive testing
 - 25. Misalignment
 - 26. Excessive weathering
 - 27. Unprotected storage

SECTION 01040 – COORDINATION

- 28. Improper shipping or handling
- 29. Theft
- 30. Vandalism

END OF SECTION 01040

SECTION 01041 – PROJECT MANAGEMENT SOFTWARE

1. SUMMARY

- a. Web based construction project management collaboration software to submit, track, distribute and collaborate on project documentation and action items.
- b. The intent of utilizing a web-based construction management application is to reduce cost and schedule risk, improve quality and safety, and maintain a healthy team dynamic by improving information flow, reducing non-productive activities, reducing rework and decreasing turnaround times.
- c. WCSD to work with Contractor to ensure directory for project is current and to be responsible for establishing and managing necessary permissions for users through duration of project.
- d. WCSD will hold a kickoff meeting with the Contractor and applicable consultants at the beginning of the project to discuss how the software will be used, routing & naming protocols, permissions & restrictions, roles & responsibilities, etc.

2. SOFTWARE CAPABILITIES (including but not limited to)

- a. Daily Log
 - i. Provides daily log entry from web and mobile with automatic capture of daily weather conditions.
 - ii. Provides ability to attach photographs to entries directly from mobile.
 - iii. Provides reporting capabilities to easily report on man-hours and activities for a certain time frame and contractor.
- b. Dashboards
 - i. Provides a dashboard that shows the status of all currently assigned items with drill down capability to see the subject, assignee and due date of each item.
- c. Deficiency Tracking
 - i. Provides a means for recording, assigning and confirming completion of any deficiency or observation noted during the course of construction.
- d. Directory
 - i. Provides a directory of all team member's contact information that is accessible from web and mobile.
- e. Documents
 - i. Provides a storage location for miscellaneous project documents with the ability to have a folder hierarchy and privacy settings on folders.

SECTION 01041 – PROJECT MANAGEMENT SOFTWARE

- ii. No storage limit.
 - iii. Provides download tracking.
- f. Drawings
 - i. Provides access to a system maintained current set of drawings on web and mobile, with access to all previous revisions as well.
 - ii. Provides automatic hyperlinking capability for detail callouts.
 - iii. Provides drawing markup capabilities on web and mobile.
 - iv. Provides ability to link RFIs, Submittals, Punchlist Items, Photos and Project Documents to the drawings.
 - v. Drawing Markups can be carried forward when new revisions are uploaded.
 - vi. Markups and linked documentation are able to be public or private.
- g. Financial Management
 - i. Provides ability to manage contracts, payment applications and change orders.
 - ii. Provides ability to view contracts and change orders from web and mobile.
- h. Inspections
 - i. Provides ability to create inspections from web and mobile.
 - ii. Provides ability to create a deficiency item from an inspection that can be assigned and tracked to completion.
- i. Meetings
 - i. Provides ability to create, edit and view meeting minutes from web and mobile.
 - ii. Provides ability to create action items with assignees and due dates from a meeting item.
- j. Mobile Accessibility
 - i. Provide native mobile applications for iOS and Android phones at a minimum that provide access to relevant project documentation, including as-built versions of Drawings and Specifications, even when there is no internet access.
- k. Photos
 - i. Provides ability to upload and view photos from web and mobile.
 - ii. Provides ability to markup photos from mobile to clarify anything important in the photo.
 - iii. Provides ability to link photos to specific locations on drawings.
- l. Punchlist
 - i. Provides ability to create punchlist items from web and mobile and link them to specific locations on the drawings.

SECTION 01041 – PROJECT MANAGEMENT SOFTWARE

- ii. Provides ability to distribute punchlist items to all contractors, for contractors to mark them as resolved with photographic proof of resolution via mobile, and for the items to be marked as complete via mobile or web.
- m. Requests for Information (RFIs)
 - i. Provides ability to create RFIs with assignees, due dates and attachments.
 - ii. Provides ability for assignees to respond to RFIs both via the software and by responding to the system generated email.
 - iii. Provides an auto-generated log of all RFIs.
- n. Schedule
 - i. Provides ability to display schedules from typical scheduling software.
- o. Specifications
 - i. Provides ability to upload project specifications and manage them at the individual specification level.
 - ii. Provides ability to view and search specifications on web and mobile.
 - iii. Provides ability to upload revisions to individual specifications and maintain all revision history.
 - iv. Provides an auto-generated current specification log that provides access to the current version of each specification.
 - v. Provides ability to link specifications to submittals and view the specification from the submittal.
- p. Submittals
 - i. Provides ability to upload a submittal register of all expected submittals.
 - ii. Provides ability to create multi-step approval workflows for submittals, with reminder notifications for the current assignee.
 - iii. Provides the ability to upload any file type without size restrictions.
 - iv. Provides an auto-generated submittal log.

3. TECHNOLOGY

- a. Fully web based with mobile apps for Windows, iOS and Android phones.
- b. Accessible without logging in through a virtual private network (VPN).
- c. Works on the current version of Internet Explorer, Google Chrome, Mozilla firefox and Apple Safari browsers.
- d. Can generate emails automatically, and all attachments are included in the emails via download links to avoid emails not being delivered due to size.

SECTION 01041 – PROJECT MANAGEMENT SOFTWARE

- e. PDF output of forms such as RFIs, Submittals, Meetings, Change Orders, etc. are available and customizable.

4. TRAINING AND SUPPORT

- a. Procore has learning portal certifications and support available online.

5. PROCEDURES

a. RFIs and Submittals

- i. The Contractor will be responsible for submitting all RFIs and Submittals through the software and assigning them to the appropriate parties.
- ii. WCSD / Architects / Engineers / Consultants etc. are responsible for posting all responses to these items via the software, including all relevant attachments.
- iii. The Contractor will distribute responses to all affected subcontractors and confirm agreement with the response by closing the item.

b. Construction Documentation

- i. The Contractor will manage Drawings, Specifications and Documents in the software to ensure that the current version of all applicable construction documentation is available to the entire team via web and mobile.
- ii. The Contractor will ensure that all RFIs which modify the current drawings are posted to the drawings and available via web and mobile within 24 hours of the RFI being responded to.

- c. Contractor will record and distribute action items via the software.

- d. Contractor will take daily site photos and make them publicly available.

e. Punchlist

- i. All punch list items will be managed through the software.
- ii. Punchlist items will be created by the Contractor while walking with the Owner and applicable consultants.

6. PRICING

- a. The cost of Procore Technologies services (software fee) has been paid in full by WCSD, but the contractor's bid shall include any costs the Contractor deems necessary to execute the use of Procore as identified above.

END OF SECTION 01041

SECTION 01045 - CUTTING AND PATCHING

PART 1 - GENERAL

1.1 RELATED DOCUMENTS

- A. Drawings and general provisions of the Contract, including all contract documents and addendums associated with this project shall apply to this section.

1.2 SUMMARY

- A. This section includes administrative and procedural requirements for cutting and patching.
- B. Related Sections: The following sections contain requirements that relate to this section:
 - 1. Division 1 SECTION 01040 - COORDINATION for procedures for coordinating cutting and patching with other construction activities.
 - 2. Division 2 SELECTIVE DEMOLITION for demolition of selected portions of the building for alterations.
 - 3. Refer to other sections for specific requirements and limitations applicable to cutting and patching individual parts of the work.
 - a. Requirements of this section apply to mechanical and electrical installations. Refer to Division 15 and 16 sections for other requirements and limitations applicable to cutting and patching mechanical and electrical installations.

1.3 SUBMITTALS

- A. Cutting and Patching Proposal: Submit a proposal describing procedures well in advance of the time cutting and patching will be performed if the Owner requires approval of these procedures before proceeding. Request approval to proceed. Include the following information, as applicable, in the proposal:
 - 1. Describe the extent of cutting and patching required. Show how it will be performed and indicate why it cannot be avoided.
 - 2. Describe anticipated results in terms of changes to existing construction. Include changes to structural elements and operating components as well as changes in the building's appearance and other significant visual elements.
 - 3. List products to be used and firms or entities that will perform work.

SECTION 01045 - CUTTING AND PATCHING

4. Indicate dates when cutting and patching will be performed.
5. Utilities: List utilities that cutting and patching procedures will disturb or affect. List utilities that will be relocated and those that will be temporarily out-of-service. Indicate how long service will be disrupted.
6. Approval by the Architect to proceed with cutting and patching does not waive the Architect's right to later require complete removal and replacement of unsatisfactory work.

1.4 QUALITY ASSURANCE

- A. Requirements for Structural Work: Do not cut and patch structural elements in a manner that would change their load-carrying capacity or load-deflection ratio.
 1. Obtain approval of the cutting and patching proposal before cutting and patching the following structural elements:
 - a. Foundation construction
 - b. Bearing and retaining walls
 - c. Structural steel
 - d. Lintels
 - e. Miscellaneous structural metals
 - f. Piping, ductwork, vessels, and equipment
- B. Operational Limitations: Do not cut and patch operating elements or related components in a manner that would result in reducing their capacity to perform as intended. Do not cut and patch operating elements or related components in a manner that would result in increased maintenance or decreased operational life or safety.
 1. Obtain approval of the cutting and patching proposal before cutting and patching the following operating elements or safety related systems:
 - a. Primary operational systems and equipment
 - b. Air or smoke barriers
 - c. Water, moisture or vapor barriers
 - d. Membranes and flashings
 - e. Fire protection systems
 - f. Noise and vibration control elements and systems
 - g. Control systems
 - h. Communication systems
 - i. Electrical wiring systems
 - j. Operating systems of special construction in Division 13 sections

SECTION 01045 - CUTTING AND PATCHING

- C. Visual Requirements: Do not cut and patch construction exposed on the exterior or in occupied spaces in a manner that would, in the Architect's opinion, reduce the building's aesthetic qualities. Do not cut and patch construction in a manner that would result in visual evidence of cutting and patching. Remove and replace construction cut and patched in a visually unsatisfactory manner.
 - 1. If possible, retain the original installer or fabricator to cut and patch the exposed work. If it is impossible to engage the original installer or fabricator, engage another recognized experienced and specialized firm.

1.5 WARRANTY

- A. Existing Warranties: Replace, patch and repair material and surfaces cut or damaged by methods and with materials in such a manner as not to void any warranties, required or existing.

PART 2 - PRODUCTS

2.1 MATERIALS, GENERAL

- A. Use materials identical to existing materials. For exposed surfaces, use materials that visually match existing adjacent surfaces to the fullest extent possible if identical materials are unavailable or cannot be used. Use materials whose installed performance will equal or surpass that of existing materials.

PART 3 - EXECUTION

3.1 INSPECTION

- A. Examine surfaces to be cut and patched and conditions under which cutting and patching is to be performed before cutting. If unsafe or unsatisfactory conditions are encountered, take corrective action before proceeding.
 - 1. Before proceeding, meet at the Project Site with parties involved in cutting and patching, including mechanical and electrical trades. Review areas of potential interference and conflict. Coordinate procedures and resolve potential conflicts before proceeding.

3.2 PREPARATION

- A. Temporary Support: Provide temporary support of work to be cut.
- B. Protection: Protect existing construction during cutting and patching to prevent damage. Provide protection from adverse weather conditions for portions of the Project that might be exposed during cutting and patching operations.

SECTION 01045 - CUTTING AND PATCHING

- C. Avoid interference with use of adjoining areas or interruption of free passage to adjoining areas.
- D. Avoid cutting existing pipe, conduit, or ductwork serving the building but scheduled to be removed or relocated until provisions have been made to bypass them.

3.3 PERFORMANCE

- A. General: Employ skilled workers to perform cutting and patching. Proceed with cutting and patching at the earliest feasible time and complete without delay.
 - 1. Cut existing construction to provide for installation of other components or performance of other construction activities and the subsequent fitting and patching required to restore surfaces to their original condition.
- B. Cutting: Cut existing construction using methods least likely to damage elements retained or adjoining construction. Where possible, review proposed procedures with the original installer; comply with the original installer's recommendations.
 - 1. In general, where cutting, use hand or small power tools designed for sawing or grinding, not hammering and chopping. Cut holes and slots as small as possible, neatly to size required, and with minimum disturbance of adjacent surfaces. Temporarily cover openings when not in use.
 - 2. To avoid marring existing finished surfaces, cut or drill from the exposed or finished side into concealed surfaces.
 - 3. Cut through concrete and masonry using a cutting machine, such as a carborundum saw or a diamond-core drill.
 - 4. Comply with requirements of applicable Division 2 sections where cutting and patching requires excavating and backfilling.
 - 5. Where services are required to be removed, relocated or abandoned, bypass utility services, such as pipe or conduit, before cutting. Cut-off pipe or conduit in walls or partitions to be removed. Cap, valve or plug and seal the remaining portion of pipe or conduit to prevent entrance of moisture or other foreign matter after bypassing and cutting.
- C. Patching: Patch with durable seams that are as invisible as possible. Comply with specified tolerances.
 - 1. Where feasible, inspect and test patched areas to demonstrate integrity of the installation.

SECTION 01045 - CUTTING AND PATCHING

2. Restore exposed finishes of patched areas and extend finish restoration into retained adjoining construction in a manner that will eliminate evidence of patching and refinishing.
3. Where removing walls or partitions extends one finished area into another, patch and repair floor and wall surfaces in the new space. Provide an even surface of uniform color and appearance. Remove existing floor and wall coverings and replace with new materials, if necessary, to achieve uniform color and appearance.
 - a. Where patching occurs in a smooth painted surface, extend final paint coat over entire unbroken surface containing the patch after the area has received primer and second coat.
4. Patch, repair or rehang existing ceilings as necessary to provide an even plane surface of uniform appearance.

3.4 CLEANING

- A. Clean areas and spaces where cutting and patching are performed. Completely remove paint, mortar, oils, putty and similar items. Thoroughly clean piping, conduit and similar features before applying paint or other finishing materials. Restore damaged pipe covering to its original condition.

END OF SECTION 01045

SECTION 01050 - FIELD ENGINEERING

PART 1 – GENERAL

1.1 RELATED DOCUMENTS

- A. Drawings and general provisions of the Contract, including all contract documents and addendums associated with this project shall apply to this section.

1.2 SUMMARY

- A. General: This section specifies administrative and procedural requirements for field engineering services including, but not limited to, the following:
 - 1. Land survey work
 - 2. Civil Engineering Services
 - 3. Damage Surveys
 - 4. Geotechnical Monitoring
- B. Related Sections: The following sections contain requirements that relate to this section:
 - 1. Division 1 SECTION 01040 – COORDINATION for procedures for coordinating field engineering with other construction activities.
 - 2. Division 1 SECTION 01300 – SUBMITTALS for submitting project record surveys.
 - 3. Division 1 SECTION 01700 – CONTRACT CLOSEOUT for submitting final property survey with Project Record Documents and recording of Owner accepted deviations from indicated lines and levels.

1.3 SUBMITTALS

- A. Certificates: Submit a certificate signed by the land surveyor or professional engineer certifying the location and elevation of improvements upon completion of construction.
- B. Final Property Survey: Submit ten (10) copies of the final property survey.
- C. Project Record Documents: Submit a record of work performed and record survey data as required under provisions of SECTION 01300 – SUBMITTALS and SECTION 01700 – CONTRACT CLOSEOUT.

SECTION 01050 - FIELD ENGINEERING

1.4 QUALITY ASSURANCE

- A. Surveyor Qualifications: Engage a land surveyor registered in the State of Nevada, to perform required land surveying services.
- B. Engineer Qualifications: Engage an engineer of the discipline required, licensed in the State of Nevada, to perform required engineering services.

PART 2 – PRODUCTS (Not Applicable)

PART 3 – EXECUTION

3.1 EXAMINATION

- A. Identification: The Owner will identify existing control points and property line corner stakes.
- B. Verify layout information shown on the drawings, in relation to the property survey and existing benchmarks, before proceeding to lay out the work. Locate and protect existing benchmarks and control points. Preserve permanent reference points during construction.
 - 1. Do not change or relocate benchmarks or control points without prior written approval. Promptly report lost or destroyed reference points or requirements to relocate reference points because of necessary changes in grades or locations.
 - 2. Promptly replace lost or destroyed project control points. Base replacements on the original survey control points.
- C. Establish and maintain a minimum of two (2) permanent benchmarks on the site, referenced to data established by survey control points.
 - 1. Record benchmark locations, with horizontal and vertical data, on Project Record Documents.
- D. Existing Utilities and Equipment: The existence and location of underground and other utilities and construction indicated as existing are not guaranteed. Before beginning site work, investigate and verify the existence and location of underground utilities and other construction.
 - 1. Prior to construction, verify the location and invert elevation at points of connection of all underground utility including but not limited to sanitary sewer, storm sewer, water service piping, electric conduits and gas service piping.

3.2 PERFORMANCE

SECTION 01050 - FIELD ENGINEERING

- A. Work from lines and levels established by the property survey. Establish benchmarks and markers to set lines and levels at each stage/story of construction and elsewhere as needed to locate each element of the project. Calculate and measure required dimensions within indicated or recognized tolerances. Do not scale drawings to determine dimensions.
 - 1. Advise entities engaged in construction activities of marked lines and levels provided for their use.
 - 2. As construction proceeds, check every major element for line, level and plumb.
- B. Surveyor's Log: Maintain a surveyor's log of control and other survey work. Make this log available for reference.
 - 1. Record deviations from required lines and levels, and advise the Architect when deviations that exceed indicated or recognized tolerances are detected. On Project Record Drawings, record deviations that are accepted and not corrected.
 - 2. On completion of foundation walls, major site improvements and other work requiring field engineering services, prepare a certified survey showing dimensions, locations, angles and elevations of construction and site work.
- C. Site Improvements: Locate and lay out site improvements, including but not limited to, pavements; stakes for grading; fill and topsoil placement; utility; slopes; invert elevations; etc.
- D. Building Lines and Levels: Locate and lay out batter boards for structures, building foundations, column grids and locations, floor levels and control lines and levels required for mechanical and electrical work.
- E. Existing Utilities: Furnish information necessary to adjust, move or relocate existing structures, utility poles, lines, services or other appurtenances located in or affected by construction. Coordinate with local Authorities Having Jurisdiction (AHJ).
- F. Final Property Survey: Prepare a final property survey showing significant features (real property) for the project. Include on the survey a certification, signed by the Surveyor, that principal metes, bounds, lines and levels of the project are accurately positioned as shown on the survey.
 - 1. Recording: At Substantial Completion, have the final property survey recorded by or with the AHJ as the official Property Survey.

END OF SECTION 01050

SECTION 01110 – PREVAILING WAGE AND APPRENTICESHIP UTILIZATION SPECIFICATION

PART 1 - GENERAL

1.1 RELATED DOCUMENTS

- A. Drawings and general provisions of the Contract, including all bid documents, addendums and all NRS 338 Prevailing Wage and Apprenticeship Utilization Act requirements associated with this project shall apply to this section. Various forms and information can be found on the Office of the Labor Commissioner's website <https://labor.nv.gov/>

1.2 SUMMARY

- A. This section includes administrative and procedural requirements for submittals required for performance of the work, including the following:
 - 1. Contractor/Subcontractor Notification
 - 2. Completion Notification
 - 3. Weekly Wage and Hour Report of Public Works Contractors.
 - 4. Weekly Wage and Hour Report submittal log.
 - 5. Certification of bidder regarding penalties for noncompliance
 - 6. Certification of bidder, proposed contractor or subcontractor regarding debarment, suspension, ineligibility of voluntary exclusion.
- B. Related Sections: The following section(s) may contain requirements that relate to this section if included:
 - 1. SECTION - 01027 APPLICATIONS FOR PAYMENT
 - 2. SECTION – 01300 SUBMITTALS

1.3 SUBMITTAL PROCEDURES

- A. Compensation:

1. No extension of contract time, overhead, or profit will be authorized because of failure to transmit any required submittals or payroll report submittals to the Owner sufficiently in advance of progress payment submittals.
2. No extension of contract time will be authorized because of failure to transmit or report of any forms.

B. Required Submittals

1. CONTRACTOR/SUBCONTRACTOR NOTIFICATION

- a. The Apparent Low Bidder is requested to submit the information on the Comprehensive Contractor/Subcontractor List for the Prime Bidder and all named (used) Subcontractors whom they engage for work within two (2) business days after Recommendation of Award, which will be supplied by the Purchasing Department.
- b. It shall be the Contractor's responsibility to comply and submit any required forms directly to the Office of the Labor Commissioner's as required by NRS 338.

2. COMPLETION NOTIFICATION

The contractor shall notify Washoe County School District when completion of all work performed under the contract is complete.

3. WEEKLY WAGE AND HOUR REPORTING OF PUBLIC WORKS CONTRACTORS

- a. The contractor and all subcontractors are required to submit Certified Weekly Wage and Hour Reports of Public Work Contractors for each weekly payroll to Washoe County School District through the use of LCP Tracker, a paperless online system for filling certified payroll. The first weekly report will begin on the Notice to Proceed date and conclude on the following Saturday. If the Notice to Proceed date falls on a Saturday, the first report will only include reporting for that day. All successive reports will begin on the following Sunday and conclude on the following Saturday. All subcontractor report numbers shall coincide with the General Contractors report numbers. If the contractor or subcontractors do not work during any weekly reporting period they still must submit a report

indicating no public work project hours were performed for that weekly period. When contract scope of work is completed including punch list work, the last report is to be clearly marked "FINAL REPORT."

- b. Weekly Wage and Hour Report of Public Works Contractors and Weekly Wage and Hour Report submittal log must be submitted into Washoe County School District LCP Tracker system within fifteen (15) calendar days following the end of the month being reported.
- c. The Prime contractor is required to designate an individual as Prime Approver for the project. The Prime Approver will oversee the reporting for all subcontractors of all tiers on the project. WCSD will set up the Prime Approver Account for the project. Thereafter, the Prime Approver will have the responsibility to use the Account to approve all payroll on the project.
- d. The prime contractor is required to assign subcontractors within the LCP Tracker system to the project and to ensure that all subcontractors are aware of the necessity to file payrolls electronically, are set up within the system and all required payrolls are filed by subcontractors of all tiers.

1.4 OWNER'S ACTION

- A. The owner will review each submittal, mark to indicate action taken, and provide review and acceptance.
 - 1. Compliance with submittal requirements is the Contractor's responsibility.

1.5 POSTINGS/SIGNAGE

- A. Each contractor engaged on a public work must post the applicable prevailing rate of wages for the project on the site of the public work in a generally visible place to workmen.
- B. Each contractor engaged in a public work must provide a sign with a white background and 6" black lettering stating, "Posted prevailing wages apply to this public works project". This sign must be posted on the site of the public work in a generally visible place to workmen. This will be maintained by the Contractor throughout the construction phase from the Notice to Proceed date through completion of the project.

PART 2 – PRODUCTS (Not Applicable)

PART 3 – EXECUTION (Not Applicable)

END OF SECTION 01110

--	--	--	--



WEEKLY WAGE AND HOUR REPORT OF PUBLIC WORK CONTRACTORS FOR THE PAYROLL PERIOD ENDING

Month and Day _____ Year _____

Pursuant to Chapter 338 of NRS and NAC, respectively, the contractor and each subcontractor shall keep or cause to be kept an accurate record showing the name and the actual per diem, wages and benefits paid to each workman employed by him in connection with the public work. The contractor or subcontractor shall ensure that a copy of the record for each calendar month is received by the public body awarding the contract no later than 15 days after the end of the month.

Report # _____ Regular Weekly Report Final Report Bid/Project # _____ PWP- _____

Project Title _____ Public Body Awarding Contract **Washoe County School District**

Prime Contractor Name & Address _____ License # _____

Subcontractor Name & Address _____ License # _____

Employee Name & State/Jurisdiction that Issued Identification	Work Classification	Hours Worked By Day							Total Hours For Week	Hourly Rate Of Pay including fringe	Hourly Fringe Benefit Contribution					Gross Amount Earned For Week	Net Wage Paid For Week
		S	M	T	W	T	F	S			H & W	Pen.	Vac.	App. Trg	Other		
		S							0								
		O							0								
		S							0								
		O							0								

Report Hours For Above Referenced Public Works Project Only

Employee Name & State/Jurisdiction that Issued Identification	Work Classification	Hours Worked By Day							Total Hours For Week	Hourly Rate Of Pay including fringe	Hourly Fringe Benefit Contribution					Gross Amount Earned For Week	Net Wage Paid For Week	
			S	M	T	W	T	F			S	H & W	Pen.	Vac.	App. Trg			Other
			1/0	1/0	1/0	1/0	1/0	1/0			1/0							
		S							0									
		O							0									
		S							0									
		O							0									
		S							0									
		O							0									
		S							0									
		O							0									
		S							0									
		O							0									

Report Hours For Above Referenced Public Works Project Only

Employee Name & State/Jurisdiction that Issued Identification	Work Classification	Hours Worked By Day							Total Hours For Week	Hourly Rate Of Pay including fringe	Hourly Fringe Benefit Contribution					Gross Amount Earned For Week	Net Wage Paid For Week	
			S	M	T	W	T	F			S	H & W	Pen.	Vac.	App. Trg			Other
			1/0	1/0	1/0	1/0	1/0	1/0			1/0							
		S							0									
		O							0									
		S							0									
		O							0									
		S							0									
		O							0									
		S							0									
		O							0									
		S							0									
		O							0									

Report Hours For Above Referenced Public Works Project Only

Employee Name & State/Jurisdiction that Issued Identification	Work Classification	Hours Worked By Day							Total Hours For Week	Hourly Rate Of Pay including fringe	Hourly Fringe Benefit Contribution					Gross Amount Earned For Week	Net Wage Paid For Week	
			S	M	T	W	T	F			S	H & W	Pen.	Vac.	App. Trg			Other
			1/0	1/0	1/0	1/0	1/0	1/0			1/0							
		S							0									
		O							0									
		S							0									
		O							0									
		S							0									
		O							0									
		S							0									
		O							0									

Report Hours For Above Referenced Public Works Project Only

Employee Name & State/Jurisdiction that Issued Identification	Work Classification	Hours Worked By Day							Total Hours For Week	Hourly Rate Of Pay including fringe	Hourly Fringe Benefit Contribution					Gross Amount Earned For Week	Net Wage Paid For Week	
			S	M	T	W	T	F			S	H & W	Pen.	Vac.	App. Trg			Other
			1/0	1/0	1/0	1/0	1/0	1/0			1/0							
		S							0									
		O							0									
		S							0									
		O							0									
		S							0									
		O							0									
		S							0									
		O							0									

Report Hours For Above Referenced Public Works Project Only

Employee Name & State/Jurisdiction that Issued Identification	Work Classification	Hours Worked By Day							Total Hours For Week	Hourly Rate Of Pay including fringe	Hourly Fringe Benefit Contribution					Gross Amount Earned For Week	Net Wage Paid For Week	
			S	M	T	W	T	F			S	H & W	Pen.	Vac.	App. Trg			Other
			1/0	1/0	1/0	1/0	1/0	1/0			1/0							
		S							0									
		O							0									
		S							0									
		O							0									
		S							0									
		O							0									
		S							0									
		O							0									
		S							0									
		O							0									

Report Hours For Above Referenced Public Works Project Only



NON-PERFORMANCE PAYROLL REPORT FOR PUBLIC WORKS PROJECTS

Pursuant to Chapter 338 of NRS and NAC, respectively, the contractor and each subcontractor shall keep or cause to be kept an accurate record showing the name and the actual per diem, wages and benefits paid to each workman employed by him in connection with the public work. The contractor or subcontractor shall ensure that a copy of the record for each calendar month is received by the public body awarding the contract no later than 15 days after the end of the month.

Report # Regular Weekly Report Final Report Bid/Project # PWP-

Project Title Public Body Awarding Contract **WASHOE COUNTY SCHOOL DISTRICT**

Prime Contractor Name & Address License #

Subcontractor Name & Address License #

Payroll period to
Month and Day Year Month and Day Year

I hereby certify that no employees or owner/operators were used on the construction of this Public Works project during the payroll period above.

Name & Title (please print) Signature Date

STATE OF NEVADA

JOE LOMBARDO
GOVERNOR

DR. KRISTOPHER SANCHEZ
DIRECTOR

BRETT K. HARRIS, ESQ.
LABOR COMMISSIONER



OFFICE OF THE LABOR COMMISSIONER
1818 COLLEGE PARKWAY, SUITE 102
CARSON CITY, NV 89706
PHONE: (775) 684-1890
FAX (775) 687-6409
OFFICE OF THE LABOR COMMISSIONER
3340 WEST SAHARA AVENUE
LAS VEGAS, NV 89102
PHONE: (702) 486-2650
FAX (702) 486-2660
EMAIL: PUBLICWORKS@LABOR.NV.GOV

2025 PREVAILING WAGE RATES WASHOE COUNTY REGION

DATE OF DETERMINATION: October 1, 2024

**APPLICABLE FOR PUBLIC WORKS PROJECTS OVER \$100,000 BID/AWARDED
OCTOBER 1, 2024 THROUGH SEPTEMBER 30, 2025**

Pursuant to Nevada Revised Statutes (NRS) section 338.030(9)(a), "If the contract for a public work: (a) Is to be awarded pursuant to a competitive bidding process, the prevailing wages in effect at the time of the opening of the bids for a contract for a public work must be paid until the completion or termination of the contract or for the 36 months immediately following the date on which the bids were opened, whichever is earlier." For contracts not awarded pursuant to competitive bidding, please see NRS section 338.030(9)(b). However, if a project exceeds 36 months new wage rates may apply pursuant to NRS section 338.030(9)(10). Prevailing Wage Rates may be adjusted based on Collective Bargaining Agreements (CBA's) and adjustments to those agreements. (See NRS 338.030)

PREVAILING WAGE DETERMINATIONS - NRS 338.030 subsection 7, the wages so determined must be:

- (a) Issued by the Labor Commissioner on October 1 of the odd-numbered year in which the survey was conducted and, except as otherwise provided in subsection 8, remain effective for 2 years after that date; and
- (b) Made available by the Labor Commissioner to any public body which awards a contract for any public work.

Senate Bill 243 passed during the 80th Nevada Legislative Session (2019) and set forth in NRS section 338.025, now requires the Labor Commissioner to calculate the Prevailing Wage Rates by region. NRS section 338.025 Prevailing wage regions. For the purpose of determining the prevailing rate of wages pursuant to NRS section 338.030, four prevailing wage regions are hereby established in this State as follows:

1. The Washoe Prevailing Wage Region consisting of Washoe County;
2. The Northern Rural Prevailing Wage Region consisting of Carson City and the counties of Churchill, Douglas, Elko, Eureka, Humboldt, Lander, Lyon, Mineral, Storey, Pershing and White Pine;
3. The Clark Prevailing Wage Region consisting of Clark County, and
4. The Southern Rural Prevailing Wage Region consisting of the counties of Esmeralda, Lincoln and Nye.

OBJECTIONS TO PREVAILING WAGE DETERMINATIONS – NRS section 338.030 subsection 2. Objections to the Prevailing Wage Determinations must be submitted within 30 days after the Prevailing Wage Determinations are issued.

Pursuant to NRS section 338.030 subsection 8, the Labor Commissioner will review the prevailing wage rates in each even-numbered year to determine if adjustments should be made.

As Amendments/Revisions are made to the wage rates, they will be posted on the website for each respective Region. Please review regularly for any Amendments/Revisions that are posted or contact our offices directly for further assistance.

Air Balance Technician	4
Alarm Installer	5
Boilermaker	6
Bricklayer	7
Carpenter	8
Cement Mason	9
Electrician – Communication Technician	10
Electrician - Lineman	11
Electrician – Neon Sign	13
Electrician - Wireman	14
Elevator Constructor	15
Fence Erector	17
Flagperson	18
Floor Coverer	19
Glazier	20
Highway Striper	22
Hod Carrier-Brick Mason	23
Hod Carrier – Plasterer Tender	24
Ironworker	26
Laborer	29
Lubrication And Service Engineer (Mobile And Grease Rack)	30
Mechanical Insulator	31
Millwright	32
Operating Engineer	35
Operating Engineer – Steel Fabricator & Erector	35
Operating Engineer – Piledriver	36
Painter	38
Piledriver (Non-Equipment)	40
Plasterer	42
Plumber/Pipefitter	43
Refrigeration	44
Roofer	45
Sheet Metal Worker	46
Soils and Material Tester	47
Sprinkler Fitter	47
Surveyor	48
Taper	49
Tile/Terrazzo Worker/Marble Mason Finisher	50
Tile/Terrazzo Worker/Marble Mason	51
Traffic Barrier Erector	53
Truck Driver	54
Well Driller	56
Group Classifications	
Labor Group Classifications	57
Operating Engineers	61

NRS section 338.010 subsection (25) “Wages” means:

- a) The basic hourly rate of pay; and
- b) The amount of pension, health and welfare, vacation and holiday pay, the cost of apprenticeship training or other similar programs or other bona fide fringe benefits which are a benefit to the worker.

NRS section 338.035 Bona Fide Fringe Benefits - Discharge of part of obligation of contractor or subcontractor engaged on public work to pay wages by making certain contributions in name of workman. “Bona fide fringe benefit” means a benefit in the form of a contribution that is made not less frequently than monthly to an independent third party pursuant to a fund, plan or program: (a) Which is established for the sole and exclusive benefit of a worker and his or her family and dependents; and (b) For which none of the assets will revert to, or otherwise be credited to, any contributing employer or sponsor of the fund, plan or program. The term includes, without limitation, benefits for a worker that are determined pursuant to a collective bargaining agreement and included in the determination of the prevailing wage by the Labor Commissioner pursuant to NRS section 338.030.

Please see NRS sections 338.010, 338.020, and 338.035 and Nevada Administrative Code (NAC) sections 338.0097 and 338.092 through 338.100 for further details on “Bona fide fringe benefits” and reporting requirements and exceptions.

Job Descriptions for Recognized Classes of Workers

Regarding job descriptions for public works projects, please take notice of the following:

1. The job description links have been redacted to include ONLY the scope of work for the craft.
2. Pursuant to NAC section 338.0095(1)(a) - A worker employed on a public work must be paid the applicable prevailing rate of wage for the type of work that the worker actually performs on the public work and in accordance with the recognized class of the worker.
3. The work description for a particular class is not intended to be jurisdictional in scope.
4. Any person who believes that a type of work is not classified, or who otherwise needs clarification pertaining to the recognized classes or job descriptions, shall contact the Labor Commissioner in writing for a determination of the applicable classification and pay rate for a particular type of work.
5. The job descriptions set forth or referenced herein supersede any, and all descriptions previously agreed upon by the Labor Commissioner in any settlement agreements or stipulations arising out of contested matters.
6. The following specific provisions, where applicable, shall prevail over any general provisions of the job descriptions:
 - Amendments to the prevailing wage determinations.
 - Group Classifications and/or descriptions recognized by the Labor Commissioner and included with wage determinations for a particular type of work in a particular county.

Zone Rates

The zone rate has been added to each applicable craft.

Premium Pay Premium pay for hours worked in excess of a shift of 8 hours or 12 hours, or such other time increment set forth in the Collective Bargaining Agreement or on a weekend or holiday.

Craft: AIR BALANCE TECHNICIAN (Union Rate)

Prevailing wage rates include the base rate as well as all applicable fringes

Air Balance Technician Journeyman.....	77.37
Air Balance Technician-Foreman.....	82.06
Air Balance Technician-General Foreman.....	86.75

ADD ZONE RATE

In addition to AIR BALANCE rates add the applicable amounts per hour, calculated based on a road from the courthouse in Reno, Nevada:

Zone 1	0 to 75 miles	\$0.00
Zone 2	75 to 100 miles	\$5.00
Zone 3	Over 100 miles	\$10.00 the employee shall be provided reasonable lodging and meal expenses.

ADD PREMIUM PAY

All hourly rates are subject to Over Time (One and one half 1 ½) of the Regular rate:

1. For all hours worked over Eight (8) Hours in one day or shift.
2. For the first Eight (8) Hours work on Saturday.

All hourly rates are subject to Double Time of the Regular Rate:

1. For all hours worked over Ten (10) Hours in one day or shift.
2. For all hours worked over Eight (8) Hours on Saturday.
3. For all hours worked on Sunday, New Year’s Day, Memorial Day, Independence Day, Friday before Labor Day, Labor Day, Nevada Day, Thanksgiving Day, Day after Thanksgiving, Day before Christmas, and Christmas Day.

RECOGNIZED HOLIDAYS

New Year’s Day, Memorial Day, Independence Day, Friday before Labor Day, Labor Day, Nevada Day, Thanksgiving Day, Day after Thanksgiving, Day before Christmas, and Christmas Day

JOB DESCRIPTION: Excerpt from Sheet Metal Local 26 Collective Bargaining Agreement

(a) manufacture, fabrication, assembling, handling, erection, installation, dismantling, conditioning, adjustment, alteration, repairing and servicing of all ferrous or nonferrous metal work and all other materials used in lieu thereof and of all HVAC systems, air veyor systems, exhaust systems, and air-handling systems regardless of material used including the setting of all equipment and all reinforcements in connection therewith; (b) all lagging over insulation and all duct lining; (c) testing and balancing of all air-handling equipment and duct work; (d) the preparation of all shop and field sketches whether manually drawn or computer assisted used in fabrication and erection, including those taken from original architectural and engineering drawings or sketches; (e) metal exterior wall systems, metal roofing; and (f) all other work included in the jurisdictional claims of International Association of Sheet Metal, Air, Rail and Transportation Workers.

Craft: ALARM INSTALLER (Non-Union Rate)

Prevailing wage rates include the base rate as well as all applicable fringes

Alarm Installer.....39.90

JOB DESCRIPTION:

Includes but is not limited to:

1. Installing or testing electrical protective signaling systems used to provide notification of fire, burglary or other irregularities on the premises of the subscriber of the system;
2. Installing of wiring and signaling units;
3. Repairing electrical protective signaling systems
4. Starting up, programming and documenting systems;

Craft: BOILERMAKER (Union Rate)
Prevailing wage rates include the base rate as well as all applicable fringes

Boilermaker.....	74.61
Boilermaker Foreman.....	78.59

ADD PREMIUM PAY

Premium pay for hours worked in excess of a shift of 8 hours or 12 hours or such other time increment set forth in the Collective Bargaining Agreement or on a weekend or holiday.

PER DIEM payments and TRAVEL pay shall be paid as follows:

The Contractor shall pay the employee Per Diem in the amount of seventy-five dollars (\$75.00) per day worked where the job site is 70 miles or more but less than 120 miles from the dispatch point.

For mileage of 120 miles or more, the daily Per Diem amount shall be ninety dollars (\$90.00) per day worked.

Where the job site is over 120 miles or more from the dispatch point, employees shall receive the I.R.S. maximum allowable per mile for transportation between the dispatch point and the job site at the beginning and conclusion of their employment.

Where a job is located two hundred and forty (240) miles or more from the dispatch point, the employee will receive one additional day's Per Diem at the beginning of employment and one additional day's Per Diem at the conclusion of employment.

JOB DESCRIPTION:

Includes but is not limited to:

1. Constructing, assembling, maintaining and repairing stationary steam boilers and boiler house auxiliaries;
2. Aligning structures or plate sections to assemble boiler frame tanks or vats;
3. Assisting in the testing of assembled vessels, directing cleaning of boilers and boiler furnaces;
4. Inspecting and repairing boiler fittings, including, without limitation, safety valves, regulators, automatic-control mechanisms, water columns and auxiliary machines.

Craft: BRICKLAYER (Union Rate)

Prevailing wage rates include the base rate as well as all applicable fringes

Bricklayer Journeyman.....53.96
Bricklayer Foreman.....55.21

ADD ZONE PAY in addition to BRICKLAYER rates add the applicable amounts per hour, calculated based on road miles of over thirty-five (35) miles from the Washoe County Courthouse in Reno, Nevada:

Zone 1	0 to 35 miles	\$0.00
Zone 2	35 to 75 miles	\$2.50
Zone 3	Over 75 miles	\$8.12

ADD PREMIUM PAY

One and one half (1 ½) the regular straight time hourly rate shall be paid:

1. For all hours worked over eight (8) hours in one day or shift.
2. For any hours worked on Saturday from midnight to midnight.

Double the regular straight time hourly rate shall be paid for all time:

1. For all hours worked over twelve (12) hours in one day or shift.
2. For any hours worked on Sunday from midnight to midnight.
3. For any hours worked on holidays from midnight to midnight.

RECOGNIZED HOLIDAYS

If any of these holidays fall on Sunday, the Monday following shall be considered a Holiday. New Year's Day, President's Day, Memorial Day, Fourth of July, Labor Day, Admission Day, Thanksgiving Day, Day after Thanksgiving Day, Christmas Day.

JOB DESCRIPTION: Excerpt from Agreement between No. NV Masonry Contractors and LIUNA Local 169.

This shall apply to and cover the work of Brick/Block Masonry, Stone Masonry, Artificial Masonry Marble Masonry.

Craft: CARPENTER (Union Rate)

Prevailing wage rates include the base rate as well as all applicable fringes

Carpenter Journeyman.....	61.42
Carpenter Foreman.....	65.26
Carpenter General Foreman.....	69.48

ADD ZONE RATE

(Building and Heavy Highway and Dam Construction)

In addition to CARPENTER rates add the applicable amounts per hour, calculated from the Washoe County Courthouse:

Zone 1	Within 75 road miles	\$0.00
Zone 2	Between 75 to 150 road miles	\$6.00
Zone 3	Between 150 to 300 road miles	\$7.00
Zone 4	In excess of 300 road miles	\$8.00

ADD PREMIUM PAY

Any work performed over eight (8) hours per day and on Saturdays shall be compensated at time and one-half (1-1/2x) the appropriate hourly rate. All work performed on Sundays, holidays and over twelve (12) hours in one (1) day shall be compensated at two times (2x) the appropriate hourly rate. In the event a day's work is lost because of severe weather conditions or major mechanical breakdown, work may be performed on a voluntary basis on a Saturday at the straight time hourly rate for eight (8) hours provided the straight time hours worked in one (1) week do not exceed forty (40) hours.

RECOGNIZED HOLIDAYS

New Year's Day, Memorial Day, 4th of July, Labor Day, Admission's Day, Thanksgiving Day, the Friday after Thanksgiving, Christmas Day.

JOB DESCRIPTION Excerpt from Southwest Regional Council of Carpenters and Affiliated Local Unions Master Labor Agreement

(1) All building construction, including but not limited to the construction, erection, alteration, repair, modification, demolition, addition, or improvement in whole or in part of any building structure. All rigging of Carpenters', and Piledrivers' materials.

(2) All heavy, highway and engineering construction, including but not limited to the construction, improvement, modification and demolition of all or any part of the streets, highways, bridges, viaducts, railroads, tunnels, airports, water supply, irrigation, flood control and draining systems, sewers and sanitation projects, dams, power houses, refineries, aqueducts, canals, river and harbor projects, wharves, docks, breakwaters, jetties, quarrying of breakwaters or rip rap stone or operations incidental to such heavy construction work and whether such work is above or below the water line level.

(3) The character of such work covered by this Agreement shall include but not be limited to all carpenter, concrete form work, shoring, drywall, metal stud, drywall finishing, plaster, scaffold, modular furniture, trade show work, insulation, acoustical, and lathing work on such construction, including but not limited to plastics and such work in connection with new methods of construction or use of materials.

(4) All interior and/or exterior wall finish work, including EIFS and other wet wall finish work.

Craft: CEMENT MASON (Union Rate)

Prevailing wage rates include the base rate as well as all applicable fringes

Cement Mason - Journeyman.....	54.42
Cement Mason - Foreman.....	58.92

ADD ZONE RATE

In addition to CEMENT MASON rates add the applicable amounts per hour, calculated from the Washoe County Courthouse:

Zone 1	0 to 75 miles	\$0.00
Zone 2	75 to 150 miles	\$6.00
Zone 3	150 to 300 miles	\$7.00
Zone 4	More than 300 miles	\$8.00

ADD PREMIUM PAY

OVERTIME – Any worked performed over eight (8) hours per day shall be compensated at time and one half the hourly rate. All work performed after twelve (12) consecutive hours shall be paid at double the hourly rate. All worked performed on Saturdays shall be compensated at time and one half the hourly rate. All Sunday and Holiday work shall be paid for at double time.

RECOGNIZED HOLIDAYS

New Year’s Day, Memorial Day, Independence Day, Labor Day, Admissions Day, Thanksgiving Day and the following Friday following Thanksgiving Day, and Christmas

JOB DESCRIPTIONS

1. All building construction, including but not limited to the construction, erection, alteration, repair, modification, demolition, addition, or improvement in whole or in part of any building structure.
2. All heavy, highway and engineering construction, including but not limited to construction, improvement, modification, demolition, of all or any part of streets and highways (including sidewalks, curbs and gutters), bridges, viaducts, rail roads, tunnels, airports, water supply, irrigation, flood control and drainage systems, sewers and sanitation projects, dams, power houses, refineries, aqueducts, canals, river and harbor projects, wharves, docks, breakwaters, jetties, quarrying of breakwater or rip-rap stone, or operation incidental to such heavy construction work.
3. The work to be performed by Cement Masons shall include but not be limited to the following, when tools of the Cement Masons trade are used or required:

Setting screeds, screed pins, curb forms and curb and gutter forms, rodding, spreading and tamping concrete, hand application of curing compounds, applying topping (wet or dry) colors or grits; using Darby and push floats, hand troweling or hand floating; marking edging, brooming or brushing, using base cove or step tools; chipping, and stoning, patching or sacking; dry packing; spreading and finishing gypsum, operating mechanical finishers (concrete) such as Clary, Jackson, Bidwell Bridge Deck Paver or similar types; grinding machines; troweling machines, floating machines powered concrete saws; finishing of epoxy and resin materials, bush hammering and exposed finishes for architectural work.

Operation of skill saw, chain saw, Laser Screed, Laser Level, Curb and Slipform machines, Epoxy Type Injection pumps, stamps or other means of texturing, any new devices, which are beneficial to the construction of or with concrete or related products.

Craft: ELECTRICIAN COMMUNICATION TECHNICIAN (Non-Union Rate)

Prevailing wage rates include the base rate as well as all applicable fringes

Communication Technician.....41.13

JOB DESCRIPTION:

ELECTRONIC COMMUNICATION TECHNICIAN, includes but is not limited to:

1. Pulling cable, installing and trimming devices, terminating loops, circuits, or other data gathering points;
2. Termination of main control panels, racks, or other head end equipment, as well as testing of all circuits from the field devices to the main control panels and/or equipment; 2016-2017 Prevailing Wage Rates – Washoe County 13
3. Utilizing test equipment for the purpose of troubleshooting and verifying the integrity of the circuits in question;
4. Using hand tools to assemble and install data communication lines and equipment computer systems, antennas and towers;
5. Disassembling equipment to adjust, repair or replace parts using hand tools;
6. Starting up, programming and documenting systems;
7. Measuring, cutting, splicing, connecting, soldering and installing wire and cable associated with communication systems.

Craft: ELECTRICIAN LINEMAN/GROUNDMAN/HEAVY EQUIPMENT OPERATOR
(Union Rate)

Prevailing wage rates include the base rate as well as all applicable fringes

Electrician-Groundman.....	39.57
Lineman-Journeyman.....	67.30
Lineman-Foreman.....	73.99
Lineman-General Foreman.....	80.76
Lineman-Equipment Man.....	51.75

ADD PREMIUM PAY

Premium pay for hours worked in excess of a shift of 8 hours or 12 hours or such other time increment set forth in the Collective Bargaining Agreement or on a weekend or holiday.

RECOGNIZED HOLIDAYS

New Year's Day, President's Day, Memorial Day, Fourth of July, Labor Day, Nevada Day, Thanksgiving Day and the Friday following, Christmas Day.

JOB DESCRIPTION:

Outside, overhead and underground construction and maintenance work on electrical transmission lines, switch yards, substations and distribution systems which shall include:

1. Pole line work (whether built of wood, metal or other material): the digging and back-filling of holes for poles or anchors (by hand or mechanical equipment): the loading or unloading, handling, sorting and moving of materials; the assembly or erection of all materials including the guying, stringing of conductors and fiber optics or other work necessary on through to the ultimate completion of such pole work.
2. Steel or metal structures used for the purpose of carrying electrical wire, conductors, or equipment (this includes transmission towers, outdoor substations, switch racks, or similar electrical structures); the moving of men, tools or equipment; the loading or unloading, handling, sorting and moving of materials; the assembly and erection of all materials used on the job site, including the assembly of the grillage and foundations, on through to the ultimate completion of such structures. Work covered shall include the grounding of all such structures except the bonding of stub-angle to rebar cage; the stringing and installation of wires, cables and insulators or other electrical equipment suspended from structure; also the handling and placing of transformers or O.C.B.'s and other related electrical equipment.

The moving of men, tools or equipment; the loading or unloading, handling, sorting and moving of materials; the assembly of all electrical materials on race-ways such as ducts, shall be performed by workmen under the Agreement. This shall also include CIC (cable in conduit), CC (coilable conduit), the placing of fish wire, the pulling of cables or wires through such race-ways, installing and making up of termination and the splicing of such conductors.

Street lighting systems where such work properly comes under the outside jurisdiction shall be handled in the same manner as pole line construction.

Installing and maintaining the catenary and trolley work and bonding of rails shall be handled in the same manner as pole line, and steel construction.

In connection with all of the above items, it is understood the scope of this Agreement shall include not only new installation work but shall also govern the repair, maintenance or dismantling of such structures, lines or equipment; the handling and operating of all equipment used to transport men, tools and/or

materials on the job site as well as the equipment used to move, raise or place materials used in the Outside Branch of the Electrical Industry shall be performed by workmen under this Agreement unless otherwise excluded herein.

Craft: ELECTRICIAN – NEON SIGN (Union Rate)

Prevailing wage rates include the base rate as well as all applicable fringes

Electrician Neon Sign Journeyman.....	63.15
Electrician Neon Sign Foreman.....	65.15
Electrician Neon Sign Truck Foreman supervising (4) or more.....	67.65

ADD PREMIUM PAY

One and one half (1 ½X) the regular straight time hourly rate shall be paid:

1. For all hours worked over eight (8) hours in one day or shift, either before or after the shift.
2. For up to 8 hours worked on Saturday from midnight to midnight.

Double (2X) the regular straight time hourly rate shall be paid for all time:

1. For all hours worked over eleven (11) hours in one day or shift, Monday thru Friday.
2. For all hours worked in excess of 8 hours on Saturday, Sundays or Holidays.

SHIFT DIFFERENTIAL

Second Shift (Swing) will be an additional \$1.25 cents per hour.

Third Shift (Graveyard) will be an additional \$1.50 per hour.

HIGH TIME (Working at heights)

1. All employees working at height of 65 feet and subject to a direct fall shall be paid an additional \$2.75 per hour in addition to their normal rate for a minimum of 2 hours.
2. All employees working at height of 125 feet or when repelling below 65 feet shall be paid an additional \$4.00 per hour in addition to their normal rate for a minimum of 4 hours.

FOREMAN/TRUCK FOREMAN

1. First employee on the job (TRUCK FOREMAN) must have a CDL and Welder certification and shall be paid \$2.00 per hour

in addition to their normal rate of pay.

2. When the first employee on the job (FOREMAN) is supervising (4) or more workers, he or she shall be paid an additional \$2.50 per hour. In addition to their normal rate of pay.

3. When the first employee on the job (TRUCK FOREMAN and FOREMAN) has a CDL and Welder certification and is supervising (4) or more workers, he or she shall be paid an additional \$4.50 per hour. In addition to their normal rate of pay.

RECOGNIZED HOLIDAYS

New Year's Day, Martin Luther King Day, President's Day unpaid holiday; double time for any hours worked, Memorial Day, Independence Day, Labor Day, Veteran's Day, Thanksgiving Day, Day after Thanksgiving Day, Christmas Eve ½ day (4 hours) unpaid holiday; straight time for first four hours worked and double time for hours worked after four hours, Christmas Day.

JOB DESCRIPTION Includes but is not limited to:

1. Installing, servicing and repairing plastic, neon and illuminated signs.
2. Ascending ladders or operating hydraulic or electric hoist to install, service, or examine sign to determine cause of malfunction.
3. Wiring, rewiring or removing defective parts and installing new parts using electrician's tools.
4. Removing sign or part of sign for repairs, such as structural fabrication, scroll repair, or transformer repair.

Craft: ELECTRICIAN WIREMAN (Union Rate)

Prevailing wage rates include the base rate as well as all applicable fringes

Wireman.....	73.88
Wireman-Cable Splicer.....	78.33
Wireman Forman.....	79.95
Wireman General Foreman.....	86.02

ADD ZONE RATE

In addition to ELECTRICIAN-Wireman, rates, add the applicable amounts per hour, calculated from Washoe County Courthouse, Reno Nevada:

Zone 1	0 to 70 miles	\$0.00
Zone 2	70 to 90 miles	\$8.00
Zone 3	90 miles and over	\$10.00

ADD PREMIUM PAY

Premium pay for hours worked in excess of a shift of 8 hours or 12 hours or such other time increment One and one half (1 ½) the regular straight time hourly rate shall be paid:

1. For all hours worked over eight (8) hours in one day or shift.
2. For the first eight (8) hours worked on Saturday

Double the regular straight time hourly rate shall be paid for all time:

3. For all hours worked over ten (10) hours in one day or shift.
4. For any hours worked on Sunday
5. For any hours worked on Holidays

Shift Rates

1. Swing shift to be paid at seventeen-point three (17.3) percent the regular straight time rate for hours between 4:30 p.m. and 1:00 a.m.
2. Graveyard shift to be paid at thirty-one-point four (31.4) percent the regular straight time rate for hours between 12:30 a.m. and 9:00 a.m.
3. Shifts are established for at least five (5) consecutive days or double the regular straight time rate shall be paid.

**Note – Double the straight time rate is the max rate paid. (No pyramiding of overtime rates)

RECOGNIZED HOLIDAYS

New Year's Day, Memorial Day, Independence Day, Labor Day, Admission Day, Veteran's Day, Thanksgiving Day, Friday following Thanksgiving Day, Christmas Day.

JOB DESCRIPTION: Excerpt from Agreement between NECA and Local Union 401, IBEW

All electrical construction, installation, or erection work including fabrication or prefabrication of boxes, brackets, bends and nipples and all electrical maintenance thereon including the final running tests. This shall include the installation and maintenance of temporary wiring and the installation of all electrical lighting, heat and power equipment, installation of all raceway systems, including underground conduits and all supports, underground utility conduits, photovoltaic power generation systems, wind power generation systems and geothermal power generating systems. Further all salvage of electrical work shall be included.

Craft: ELEVATOR CONSTRUCTOR (Union Rate)

Prevailing wage rates include the base rate as well as all applicable fringes

Elevator Constructor-Journeyman Mechanic.....	126.41
Elevator Constructor-Journeyman Mechanic In Charge.....	137.32

ADD PREMIUM PAY

Work performed on Construction Work on Saturdays, Sundays and before and after 30 the regular working day on Monday to Friday, inclusive, shall be classed as overtime, and paid for at double the rate of single time.

RECOGNIZED HOLIDAYS

New Year's Day, Memorial Day, Independence Day, Labor Day, Nevada Day, Veteran's Day, Thanksgiving Day, Day after Thanksgiving Day, Christmas Day.

JOB DESCRIPTION: Excerpt from Agreement of International Union of Elevator Constructors Local 8.

The handling and unloading of all equipment coming under the jurisdiction of the Elevator Constructor, from the time such equipment arrives at or near the building site, shall be handled and unloaded by the Elevator Constructors. Mechanical equipment such as a forklift or truck mounted swing boom may be used by the Elevator Constructors. A derrick, crane or material hoist can be used under the supervision of Elevator Constructors to handle and unload the heavy material described in

Par. 5(a). Where unusual conditions are expected to exist prior to delivery of equipment at or near the building site in regard to handling and unloading of equipment in the primary or secondary jurisdiction of the local union, the Company shall contact the Local's Business Representative to make appropriate arrangements for the handling and unloading of such equipment. In areas outside the jurisdiction of the local union, the Company shall contact the Regional Director.

(b) The erecting and assembling of all elevator equipment to wit: electric, hydraulic, steam, belt, dumbwaiters, residence elevators, parking garage elevators (such as Bowser, Pigeon Hole, or similar types of elevators), shuttles, compressed air and handpower, automatic people movers, monorails, airport shuttles and like-named devices used in the transportation of people for short distances of travel (less than 5 miles), as well as vertical reciprocating conveyor systems.

(c) It is understood and agreed that the preassembly of all escalators, moving stairways and link belt carriers that may be done in the factory shall include the following:

1. Truss or truss sections with tracks, drive units, machines, handrail drive sheaves, drive chains, skirts on the incline sections but not curved sections, step chains and steps installed and permanently aligned.
2. Balustrade brackets may be shipped attached but not aligned.
3. Setting of all controllers and all wiring and conduit from the controller.

All other work on escalators, moving stairways and link belt carriers shall be performed in the field before or after the truss or truss sections are joined and/or hoisted and placed in permanent position. This includes any and all work not done in the factory. The erecting and assembly of all theater stage and curtain elevator equipment and guides and rigging thereto, organ consoles and orchestra elevators

- (d) All wiring, conduit, and raceways from main line feeder terminals on the controller to other elevator apparatus and operating circuits. Controllers are not to be shipped from the factory with extended wiring attached thereto.
- (e) The erecting of all guide rails.
- (f) The installation of all grating under the control of the Company. The installation of all counterweight screens, overhead work, either wood or iron, and all material used for mounting of elevator apparatus in machine room, overhead or below.
- (g) The drilling of overhead beams for attaching machines, sheaves, kick angles, and all other elevator equipment.
- (h) The setting of all templates.
- (i) All foundations, either of wood or metal, that should take the place of masonry.
- (j) The assembly of all cabs complete.
- (k) The installation of all indicators.
- (l) The erecting of all electrical or mechanical automatic or semi-automatic gates complete.
- (m) The hanging of all automatic or semi-automatic elevator hoistway doors, together with the installation of hangers and tracks.
- (n) The installation of all devices for opening and closing and locking of elevator car and hoistway doors and gates.
- (o) The drilling of doors for mounting of closing devices.
- (p) The drilling of angle supports for mounting of closing devices except one template hole.
- (q) The drilling of sills for sill trips.
- (r) The operating of temporary cars.
- (s) The setting of all elevator pressure open or pit tanks.
- (t) The setting of hydraulic power units (power units include: motor, pump, drive valve system, internal piping, muffler, internal wiring, controller and tank). Where power units arrive in parts, they shall be assembled at the job site. The wiring and piping to and between multiple hydraulic power units shall be performed at the job site.
- (u) All air cushions with the exception of those built of brick or those put together with hot rivets.
- (v) Landing door entrances.

Craft: FENCE ERECTOR (Union Rate)

Prevailing wage rates include the base rate as well as all applicable fringes

Fence Erector.....51.03

ADD ZONE RATE

In addition to FENCE ERECTOR rates add the applicable amounts per hour, calculated based on a road miles from either the Carson City Courthouse or the Washoe County Courthouse:

Zone 1	0 to 75 miles	\$0.00
Zone 2	75 to 150 miles	\$6.00
Zone 3	150 to 300 miles	\$7.00
Zone 4	300 miles or over	\$8.00

No remote area pay shall be paid within ten (10) miles of employee’s permanent place of residence in the State of Nevada.

ADD PREMIUM PAY

One and one half (1 ½) the regular straight time hourly rate shall be paid:

1. For all hours worked over eight (8) hours in one day or shift.
2. For any hours worked on Saturday from midnight to midnight.

Double the regular straight time hourly rate shall be paid for all time:

1. For all hours worked over twelve (12) hours in one day or shift.
2. For any hours worked on Sunday from midnight to midnight.
3. For any hours worked on holidays from midnight to midnight.

RECOGNIZED HOLIDAYS

If any of these holidays fall on Sunday, the Monday following shall be considered a Holiday. New Year’s Day, President’s Day, Memorial Day, Fourth of July, Labor Day, Admission Day, Thanksgiving Day, Day after Thanksgiving Day, Christmas Day.

JOB DESCRIPTION:

Includes but is not limited to:

1. Erecting or repairing chain link, wooden, tortoise, wire/wire mesh, or temporary fencing;
2. Mixing and pouring concrete around bases of posts and tamping soil into post hole to embed post;
3. Digging post holes with a spade, post hole digger or power-driven auger;
4. Aligning posts through the use of lines or by sighting;
5. Verifying vertical alignment of posts with a plumb bob or spirit level.

Craft: FLAG PERSON (Union Rate)

Prevailing wage rates include the base rate as well as all applicable fringes

Flag Person.....48.91

ADD ZONE RATE

In addition to FLAG PERSON add the applicable amounts per hour, calculated based on a road miles from either the Carson City Courthouse or the Washoe County Courthouse:

Zone 1	0 to 75 miles	\$0.00
Zone 2	75 to 150 miles	\$6.00
Zone 3	150 to 300 miles	\$7.00
Zone 4	300 miles or over	\$8.00

No remote area pay shall be paid within ten (10) miles of employee’s permanent place of residence in the State of Nevada.

ADD PREMIUM PAY

One and one half (1 ½) the regular straight time hourly rate shall be paid:

1. For all hours worked over eight (8) hours in one day or shift.
2. For any hours worked on Saturday from midnight to midnight.

Double the regular straight time hourly rate shall be paid for all time:

1. For all hours worked over twelve (12) hours in one day or shift.
2. For any hours worked on Sunday from midnight to midnight.
3. For any hours worked on holidays from midnight to midnight.

RECOGNIZED HOLIDAYS

If any of these holidays fall on Sunday, the Monday following shall be considered a Holiday. New Year’s Day, President’s Day, Memorial Day, Fourth of July, Labor Day, Admission Day, Thanksgiving Day, Day after Thanksgiving Day, Christmas Day.

JOB DESCRIPTION

FLAG PERSON, includes but is not limited to:

1. Directing movement of vehicular traffic through construction projects;
2. Distributing traffic control signs and markers along site in designated pattern;
3. Informing drivers of detour routes through construction sites;

Craft: FLOOR COVERER (Union Rate)

Prevailing wage rates include the base rate as well as all applicable fringes

Floor Coverer Journeyman.....	60.65
Floor Coverer Foreman.....	64.49

ADD PREMIUM PAY

Any work performed over eight (8) hours per day and on Saturdays shall be compensated at time and one-half (1-1/2x) the appropriate hourly rate. All work performed on Sundays, holidays and over twelve (12) hours in one (1) day shall be compensated at two times (2x) the appropriate hourly rate. In the event a day's work is lost because of severe weather conditions or major mechanical breakdown, work may be performed on a voluntary basis on a Saturday at the straight time hourly rate for eight (8) hours provided the straight time hours worked in one (1) week do not exceed forty (40) hours.

RECOGNIZED HOLIDAYS

New Year's Day, Memorial Day, Independence Day, Labor Day, Admissions Day, Thanksgiving Day, Day after Thanksgiving Day, Christmas Day.

JOB DESCRIPTION: Excerpt from Southwest Mountain States Regional Council of Carpenters.

All work in connection with the installation of floor coverings (with the exception of wood floors which are covered by the Master Labor Agreement) such as measuring, cutting, installing, or removal and other preparation for installation of all types of floor covering. All types of floor covering regardless of material (except wood flooring), including but not limited to all types of carpeting, linoleum, vinyl, cork, laminate floors; glue down wood floor applications; rubber, cork, asphalt, linoleum or other types of tile; artificial turf and sports surfaces; any type of resilient flooring such as epoxy, polyurethane or similar materials regardless of how applied; and ceramic tile and stone. Included in the work covered is the application or installation of any type of moisture barrier and any type of underlayment or subfloor in connection with a flooring installation.

Craft: GLAZIER (Union Rate)

Prevailing wage rates include the base rate as well as all applicable fringes

Glazier Journeyman.....	33.96
Glazier Foreman.....	36.41
Glazier Superintendent.....	37.63

ADD PREMIUM PAY

One and one half (1 ½) the regular straight time hourly rate shall be paid:

1. For first two (2) hours worked over eight (8) on a regular five (5) day week.
2. For all hours worked on Saturday. Employees shall not work less than four (4) hours.

Double the regular straight time hourly rate shall be paid for all time:

1. For all hours worked beyond ten (10) hours shall be paid at two (2 X) times the straight time rate.
2. For all hours worked on Saturday beyond 8 hours (2 X) times the straight time rate.
3. For hours worked Sunday and Recognized Holidays. Employees shall not be employed for less than four (4) hours.

*Also, if there is less than 10 hours between shifts, the 2nd shift becomes an extension of the 1st shift.

*Shift Differential: To be paid for all work performed between the hours of 5:30 pm to 5 am and it will be compensated at 10% differential for all hours worked including overtime. Overtime that falls between these hours will still be paid at the appropriate overtime rate.

20.1 High Pay – work that is thirty (30) or more feet in height above grade on an elevated, mechanically operated platform (including but not limited to: swing stage, boatswain chair, crane basket, heck lift, boom lift), rappelling work, work at slab edge outside the perimeter safety cable or work at slab edge inside the perimeter safety cable if the work being performed puts the employee in a free fall situation because the perimeter safety cable is no longer at or near waist level shall be paid at the rate of one dollar (\$1.00) per hour above the straight time rate for actual hours worked. High time shall be paid in addition to all other premiums involved.

25.2 Foremen:

a) The selection of the individual to act as foreman shall be at the discretion of the Employer. On outside jobs lasting three (3) days or more and which four (4) workers or more are employed, one (1) foreman will be designated and he shall be paid ten percent (10%) per hour over the highest journeyman Glazier supervised. Inside foreman shall receive ten percent (10%) per hour above the journeyman’s wage scale.

b) When a glazier is requested to perform welding on the job site, he/she will be compensated one dollar (\$1.00) over his regular rate of pay. All equipment, including hoods, leather and gloves, will be supplied by the Employer.

RECOGNIZED HOLIDAYS

New Year’s Day, President’s Day, Memorial Day, Independence Day, Labor Day, Veteran’s Day, Thanksgiving Day, Day after Thanksgiving Day, Christmas Day.

JOB DESCRIPTION: Excerpt from Agreement between DC 16 and Glazing Contractors Associations of NV and Independent Contractors

General Glazing shall include the layout and setting by hand or with machines, cutting, preparing handling or removal of the following and incidental and supplemental to such work: setter of art glass, prism glass,

beveled glass, leaded glass, automobile glass, window glass, mirrors of all types, wire glass, ribbed glass, ground glass, colored glass, figured glass, vitrolite glass, carrara glass, and all other types of opaque glass; glass chalk boards, structural glass, tempered and laminated glass, thiokal, neoprene and all other types of glass cements, all types of insulating glass units, solar heat collectors containing glass or glass substitutes, glass hand rail, electric glass, bathroom fixtures, all plastics when used in place of glass, all other similar materials when used in place of moldings, tubber, lead and all types of mastic in wood, iron, aluminum or sheet metal, sash skylights, doors, frames, stone, wall cases, show cases, books cases, sideboards, partitions, automatic doors, automatic sliding doors, revolving doors, luminous ceilings, gaskets, and plastic mirrors, the installation of the above materials, temporary or permanent, on or for any building in the course of repair, remodel, construction or alteration.

The installation of all glass framing or support systems for the same such as extruded, rolled or fabricated metals or any materials that replace the same, such as plastics, metal tubes, mullions, metal facing materials, muttins, facia trim moldings, porcelain panels, skylights, showcase doors and relative materials, including those in any or all of the buildings related to the store front and window wall, curtain wall, stop wall, skylight and dome construction. Glazing and installation of door and window frames, such as patio sliding or fixed doors, vented or fixed windows, shower doors, bath tub enclosures, screens storm stash where the glass becomes an integral part of the finished products, the tinting and coating of glass for the reflecting of heat and light, showcase tops, glass shelving of all types and table tops. In addition, such caulking, glass to glass, glass to metal, metal to concrete and panel to panels.

Production, maintenance, including all incidental and supplemental to, but not limited to Employees, and Employees who are engages int eh cutting, preparing, handling and selecting of glass and /or mirror, bevellers, silverers, blockers, scratch polishers, sand-blasters, flat glass wheel cutters, miters cutters, engraver, hole-drilling machine operations, belt sanding, automatic beveling, multi-grove edging machines, semi- and automatic-cutting machines, grinding, polishing unpacking ad racking or glass, glass packing, glass and mirror cleaning, mirror stripping, all operations in the manufacturing, framing and fabrication and assembling of all insulating units, assembling of all glass insulated solar heat collectors containing glass or glass substitutes, molding or mirrors, manufactured and assembly of sliding glass or mirror doors, the operating of all machines and equipment for these operations, oven operations, glass hangers, glass benders and operators, safety glass fabricators, inspectors, janitors, maintenance mechanics, loading and unloading or truck and railroad cars.

Craft: Highway Striper (Union Rate)

Prevailing wage rates include the base rate as well as all applicable fringes

Highway Striper.....	53.53
Highway Striper Foreman.....	54.03

ADD ZONE RATE

In addition to HIGHWAY STRIPER rates add the applicable amounts per hour, calculated based on a road miles from either the Carson City Courthouse or the Washoe County Courthouse:

Zone 1	0 to 75 miles	\$0.00
Zone 2	75 to 150 miles	\$6.00
Zone 3	150 to 300 miles	\$7.00
Zone 4	300 miles or over	\$8.00

No remote area pay shall be paid within ten (10) miles of employee’s permanent place of residence in the State of Nevada.

ADD PREMIUM PAY

One and one half (1 ½) the regular straight time hourly rate shall be paid:

1. For all hours worked over eight (8) hours in one day or shift.
2. For any hours worked on Saturday from mid ight to midnight.

Double the regular straight time hourly rate shall be paid for all time:

1. For all hours worked over twelve (12) hours in one day or shift.
2. For any hours worked on Sunday from midnight to midnight.
3. For any hours worked on holidays from midnight to midnight.

RECOGNIZED HOLIDAYS

If any of these holidays fall on Sunday, the Monday following shall be considered a Holiday.

New Year’s Day, Memorial Day, 4th of July, Labor Day, Admission Day, Thanksgiving Day, Day after Thanksgiving Day, Christmas Day.

JOB DESCRIPTION:

Includes but is not limited to:

1. Painting highways, streets and parking surfaces by using manually propelled or mechanically propelled machines, brushes, rollers or spray guns;
2. Installing any device or application of any material used in lieu of paint for traffic direction, including, without limitation, buttons, tapes, plastics, rumble bars and other similar materials;

Craft: Hod Carrier-Brick Mason Tender (Union Rate)

Prevailing wage rates include the base rate as well as all applicable fringes

Brick Mason Journeyman.....	51.28
Brick Mason Foreman.....	51.68

ADD ZONE RATE

In addition to Hod Carrier Brick Mason Tender rates add the applicable amounts per hour, calculated based on road miles from either the Carson City Courthouse or the Washoe County Courthouse:

Zone Rate	75 miles and over	\$8.13
-----------	-------------------	--------

ADD PREMIUM PAY

One and one half (1 ½) the regular straight time hourly rate shall be paid:

1. For all hours worked over eight (8) hours in one day or shift.
2. For any hours worked on Saturday from midnight to midnight.

Double the regular straight time hourly rate shall be paid for all time:

1. For all hours worked over twelve (12) hours in one day or shift.
2. For any hours worked on Sunday from midnight to midnight.
3. For any hours worked on holidays from midnight to midnight.

RECOGNIZED HOLIDAYS

If any of these holidays fall on Sunday, the Monday following shall be considered a Holiday.

New Year’s Day, President’s Day, Memorial Day, Fourth of July, Labor Day, Admission Day, Thanksgiving Day, Day after Thanksgiving Day, Christmas Day.

JOB DESCRIPTION: Excerpt from Agreement between No, NV Masonry Contractors and LIUNA Local 169

Conveying of all materials used by the Brick and Stone Masons from the first point of delivery to the Mechanic whether done manually or by a piece of machinery or equipment devised to replace the wheelbarrow or buggy, including but not limited to the forklift. The handling of Bricks, Blocks, mortar, or any other material to serve the bricklayer in any capacity building and dismantling scaffolds of any kind or type used by Bricklayers for masonry work including but not limited to tower scaffolds, access scaffolds, or other specialty scaffolds, mixing and tempering mortar by hand and/or machine, mixing grout and cleaning up after the bricklayer, the repairing and maintenance of all equipment, either on the job or in the yard.

Craft: Hod Carrier-Plasterer Tender (Union Rate)

Prevailing wage rates include the base rate as well as all applicable fringes

Plasterer Tender-Journeyman.....	51.62
Plasterer Tender- Gun Tender.....	52.62
Plasterer Tender-Foreman.....	52.98

ADD ZONE RATE

In addition to: HOD CARRIER-PLASTERER TENDER rates add the applicable amounts per hour, calculated based on road miles from either the Carson City Courthouse or the Washoe County Courthouse:

Zone Rate	75 miles and over	\$8.00
-----------	-------------------	--------

ADD PREMIUM PAY

One and one half (1 ½) the regular straight time hourly rate shall be paid:

1. For all hours worked over eight (8) hours in one day or shift.
2. For any hours worked on Saturday from mid night to midnight.

Double the regular straight time hourly rate shall be paid for all time:

1. For all hours worked over twelve (12) hours in one day or shift.
2. For any hours worked on Sunday from midnight to midnight.
3. For any hours worked on holidays from midnight to midnight.

RECOGNIZED HOLIDAYS

If any of these holidays fall on Sunday, the Monday following shall be considered a Holiday. New Year’s Day, President’s Day, Memorial Day, Fourth of July, Labor Day, Admission Day, Thanksgiving Day, Day after Thanksgiving Day, Christmas Day.

JOB DESCRIPTION: Excerpt from Agreement between Plasterers Contractors and LIUNA Local Union 169

Any Employee within the scope of this division tending or serving any other worker performing plasterers work, any plasterer, plasterers, or apprentices in any capacity performing plasterers work including but not limited to, handling and conveying of all materials after delivery used by plasters, including but not limited to, inside finish coat, outside finish coat, brown coat, scratch coat, sprayed or trowled on fireproofing, EIFS systems, and other materials or systems for the same or similar purpose whether done manually or by a piece of machinery or equipment devised to replace the wheelbarrow or buggy, including but not limited to the forklift, tusk hoist, and rigging and signaling for cranes to the point or points of application or installation, making mixing and preparing after delivery all materials used by plasters, whether by hand or machine including but not limited to mixers, pumps for plaster or fire proofing, plaster, finish coats, fireproofing, including Monocoat, Cafco or other materials for the same or similar use, moving any rolling scaffolding, building and handling all necessary trestle, scaffolding and planking of scaffolding for plasterers and lathers, building mortar boxes, mortar boards and stands, and the repairing and maintenance of all equipment either on the job or in the yard, the spreading of all temporary protective drop cloths, building paper or plastic covers and taping of same (in a composite crew with the plasterers when necessary), the cleaning of all floors, and debris, behind the plasterers or any other worker performing plasterers work in connection with the work performed all work necessary for cold weather protection and cure including but not limited to handling installing or tending to blankets, visqueen, and space heaters, and running putty.

Tending to plasterers or any other worker performing plasterers work on EFIS system work shall include all work after the wallboard is installed including but not limited to any preparatory sealing or leveling, placing foam, mesh, and plaster including any rough, finish, and color coats.

For sprayed on fire proofing work only, including Monocoat, Cafco or other materials for the same or similar use an Employer signatory to this Agreement and the Local 169, Laborers Master Agreement may employ Laborers at the Group 1 wage rate to perform overspray protection, the spreading of all temporary protective drop cloths, building paper or plastic covers and taping of same, the cleaning of all floors, and debris, cold weather protection and cure including but not limited to handling installing or tending to blankets, visqueen, and space heaters and moving rolling scaffolding.

Craft: Ironworker (Union Rate)

Prevailing wage rates include the base rate as well as all applicable fringes

SEE AMENDMENT 1

Ironworker - Journeyman.....	82.86
Ironworker - Foreman.....	87.61

ADD ZONE RATE

In addition to Iron Worker rates add the applicable amounts per day, calculated based on a road mile from the Reno City Hall or Las Vegas City Hall.

Zone 1	60 to 75 miles	\$20.00
Zone 2	75 to 100 miles	\$25.00
Zone 3	100 miles and over	\$75.00

ADD PREMIUM PAY

One and one half (1X) the regular straight time hourly rate shall be paid:

1. For the first two (2) hours worked in excess of eight (8) on a regular workday Monday-Friday
2. For the first eight (8) hours on Saturday

Double the regular straight time hourly rate shall be paid for all time:

1. For all hours worked over ten (10) hours in one day or shift.
2. For any hours worked on Sunday.
3. For all hours worked over eight (8) on Saturday
4. For all hours worked on Holidays

Shift Pay

1. 2nd shift add 6% of hourly wage
2. 3rd shift add 13% of hourly wage
3. Dedicated shift add 6% of hourly wage

RECOGNIZED HOLIDAYS

New Year's Day, President's Day, Memorial Day, Independence Day, Labor Day, Admission (Nevada) Day, Veterans Day, Thanksgiving Day, Day after Thanksgiving Day, Christmas Day.

JOB CLASSIFICATION: Excerpt from Agreement between NV AGC and DC of Ironworkers

Field fabrication and/or erection or deconstruction of structural, ornamental and reinforcing steel, including but not limited to the fabrication, rigging and signaling, erection and construction of all iron and steel, ornamental lead, bronze, brass, copper and aluminum, plastics and all other substitute materials, including, but not limited to, composites, carbon fiber and fiberglass, all barrier railings, handrail, aluminum, steel, glass and plastic, reinforced concrete structures or parts thereof; bridges, viaducts, inclines, dams, docks, dredges, vessels, locks, gates, guides, aqueducts, reservoirs, spillways, flumes, caissons, cofferdams, subways, tunnels, cableways, tramways, monorails, blast furnaces, stoves, kilns, coolers, crushers, agitators, pulverizers, mixers, concentrators, ovens, cupolas, roof decking such as but not limited to "Cofar", "Trusdeck", Mahon "M"; smoke conveyors, penstocks, flag poles, drums, shafting, shoring, fur and storage rooms, fans and hot rooms, stacks, bunkers, conveyors, dumpers, elevators, vats, tanks, enamel tanks, enamel vats, towers, pans, hoppers, plates, anchors, caps, corbels, lintels, Howe and combination trusses, grillage and foundation work, grating, bucks, partitions, hanging ceilings, hangers, clips, brackets, flooring, floor construction and domes, rolling shutters, curtains, frames; aluminum, rolling fire, won and iron doors, including supports; cast tiling, air ducts, duct and trench frames and plates; wire work, railings, wire cable including pipe, guards, fencing, grill work, sidewalk and vault lights, skylights, roofs, canopies, light steel

framing, marquees, awnings and other related equipment elevator and dumb waiter enclosures, elevator cars, tracks, fascias, aprons, operating devices, steel and aluminum sash, hardware and screens, frames, fronts, lockers, racks, book stacks, tables, shelving, metal furniture, seats, chutes, escalators, stairways including pre-engineered stairs, ventilators, boxes, fire escapes, signs, jail and cell work, safes, vaults, vault doors, safe deposit boxes, corrugated sheets when attached to steel frames, including insulation; frames in support of boilers; materials altered in field such as framing, cutting, bending, drilling, burning and welding including by acetylene gas and electric machines; metal forms and false work pertaining to concrete construction; seismic isolation systems and dampening systems including base isolators, sectional water tube and tubular boilers and stokers; traveling sheaves, vertical hydraulic elevators, bulkheads, skip hoists, making and installation of articles made of wire and fibrous rope, rigging in connection with pumps, compressors, forced and induced draft fans, air meters, Bailey meters, agitators, oxygen converters, cinder machines, pelletizing machines, reactor vessels, reactor spheres, completed tanks and assembled sections of completed tanks, scroll cases, refineries, hydroelectric power houses and steam plants, cogeneration plants, vessels and government departments; false work, travelers, scaffolding, pile drivers, sheet piling, derricks and powered derrick swinger including the erection, installation, handling and operating. Cranes erection, installation, handling and operating of same on all forms and types of construction work. The operation of Valla and Spider type battery and/or propane powered portable floor cranes having no operator seat utilized to install ironworker scope of work and the same on all forms and types of construction work. Crane work at the ports, including hammer-head cranes, container cranes and rubber tire cranes. Offloading, relocations, and commissioning of all burning and removal of sea bracing track layout; erection of apex boom extensions, back reach extensions, and rail replacement. Includes all welding, containment and structural modifications of the aforementioned items; railroad bridge work including maintenance thereof; moving, hoisting and lowering of machinery, modules, skid modules and placing of same on foundation, including bridges, cranes, intermittent use forklifts, derricks, buildings, piers and vessels; loading, unloading, necessary maintenance, erection, installation, removal, wrecking and dismantling of all of the above and all reinforcing work and submarine diving in connection with or about same; erection of steel towers, chutes and spouts for concrete where attached to towers and handling and fastening of cables and guys for same; unloading, racking, sorting, cutting, bending, hoisting, placing and tying including the use of any and all mechanical tying devices, burning and welding including stud welding of all iron, steel and metal in reinforced concrete construction including mesh for floor arches and the making of hoops and stirrups, metal forms and metal supports thereof; jacking of slip forms, installation of all wire, cable, parabolic cans, steel and all other materials, including, but not limited to, composites, carbon fiber and fiberglass, used for the purposes of prestressing including grouting of ducts, post stressing concrete girders, beams, columns, etc.; loading, unloading, hoisting, handling, signaling, placing and erection of all prestressed, post stressed, precast materials, G.F.R.C., Dryvit System, including the securing by bolting and/or welding and the installation of steeltex and wire mesh of any type when used for reinforced concrete construction; erection of all curtain wall; glass handrail; stay in place deck; automated and/or mechanical parking structures; offloading, staging, hoisting and setting of modular structures and micro-units; curtain wall systems and associated sealants. Window wall and entrances, panels, insulated and non-insulated, factory and field assembled, porcelain enameled panels, ceramic, laminated spandrelite, louvers and sunscreens; application of thiokol, neoprene and other sealants used to seal materials installed by Iron Workers; installation and handling of phenolic panels, including but not limited to, Trespa products and all similarly related materials and/or systems; installation of metal window stools and sills; installation of aluminum, bronze and steel thresholds; erection and dismantling of all types of cranes and changing of booms; erection of rock, sand and gravel plants, dismantling and loading out conveyors, aggregate plants, batch plants, ableways, refrigeration plants, etc.; erection and dismantling of Monigan walking dragline, launchhammer bucket wheel excavator and other trenching equipment; signaling on highlines, whirley cranes and derricks, buck hoists, man hoists, fork lifts, material towers and scanning antennae; metal and steel supports of all types; fabrication, assembling and erection of offshore drilling platforms or similar installations; dust collectors, precipitators, multi-plate, specialty welding processes, unloading, loading, hoisting, handling and rigging of all building materials delivered to the job site; hanging ceilings, tees, channels, beams, acoustical elements, sound barriers, computer floors, etc.;

installation of stage rigging (including counterweights), curtains, draperies, traverse rods, tracks, cables, window cleaning equipment, powered work platforms, including and loading and unloading, erection installation and removal of powered chassis mounted elevating mast climbing work platforms, rigging in connection with display shows; ski lifts, etc.; wrecking of bridges, viaducts, elevated roads and structural steel and iron in buildings; all steel frames for openings, all porches, verandas, canopies and balconies; all overhead travelers, duo rails, tram rails; erection, setting, repairing of guard or collision rails on bridges and approaches, road ways or any other structures; handling and setting of all types of steel and metal joists, including metal box joists for truss lab and preformed keystone shaped metal joists; erection of steel and metal houses and packaged buildings; all translucent and plastic material on steel frame construction; the erection of solar energy systems, including but not limited to, photo voltaic, heliostat and parabolic systems, energy producing windmill type towers, wind turbine erection to included, but not limited to, prep work, boltup, tensioning or torque of bolts on base and all tower section turbine and blade assemblies; nuclear reactors, electromagnetic shielding plates and atomic vessels including all component parts; the plumbing, aligning and leveling of all materials and equipment through the use of optical instruments, LASER beams, etc., and the use of instruments to establish layout, installation and disposition of ironworker installed scope of work; the unloading, distributing, stockpiling and handling of all materials coming under the jurisdictional claims of the UNION such as to rail heads, storage yards, loading and unloading, hoisting, handling, signaling of all fabricated material and equipment at the jobsite (except FOB deliveries) related to the Iron Workers jurisdiction that is within the individual employers' contractual scope of work including from and to barge and ships to a lay down yard or construction project, etc., shall be done by the Iron Workers.

All reinforcing work in connection with field fabrication, including but not limited to the pre-assembly of reinforcing cages, loading and unloading, handling, racking, sorting, cutting, bending, hoisting, intermittent use of forklifts, placing, burning, welding and tying of all material including the use of any and all mechanical tying devices, or substitute materials, including but not limited to, composites, carbon fiber and fiberglass, stainless steel, used to reinforce concrete construction shall be done by Iron Workers within the individual employers' scope of work at the jobsite, excluding FOB deliveries. A working Iron Worker shall be employed for maintenance on jobs of substantial size while concrete is being poured on reinforcing steel, wire mesh and paper back steeltex but will not be required as a stand-by man. All work in connection with the installation, alignment, repair & modification of panelized roofing systems, pre-engineered fabric structures, aluminum clarifier coverings, carports, ministorages, and dock planks. All work in connection with the installation, alignment, repair and modification of bleachers, planking and stadium seating. All work in connection of installation of amusement rides including, but not limited to, the erection and alignment of all track, machinery and related components.

Craft: Laborer (Union Rate)

Prevailing wage rates include the base rate as well as all applicable fringes

Landscaper	45.62
Furniture Mover	47.12
Group 1.....	50.78
Group 1A.....	48.91
Group 2.....	50.88
Group 3.....	51.03
Group 3A.....	54.46
Group 4.....	51.28
Group 4A.....	53.78
Group 5.....	51.58
Group 5A.....	53.53
Group 5A Foreman.....	54.03
Group 6	
Nozzlemen, Rodmen.....	50.58
Gunmen, Materialmen.....	50.58
Reboundmen.....	50.93
Gunit Foreman.....	51.98

ADD ZONE RATE

In addition to LABORER rates add the applicable amounts per hour, calculated based on a road miles from either the Carson City Courthouse or the Washoe County Courthouse:

Zone 1	0 to 75 miles	\$0.00
Zone 2	75 to 150 miles	\$6.00
Zone 3	150 to 300 miles	\$7.00
Zone 4	300 miles or over	\$8.00

No remote area pay shall be paid within ten (10) miles of employee’s permanent place of residence in the State of Nevada.

ADD PREMIUM PAY

One and one half (1 ½) the regular straight time hourly rate shall be paid:

1. For all hours worked over eight (8) hours in one day or shift.
2. For any hours worked on Saturday from mid night to midnight.

Double the regular straight time hourly rate shall be paid for all time:

1. For all hours worked over twelve (12) hours in one day or shift.
2. For any hours worked on Sunday from midnight to midnight.
3. For any hours worked on holidays from midnight to midnight.

RECOGNIZED HOLIDAYS

If any of these holidays fall on Sunday, the Monday following shall be considered a Holiday. New Year’s Day, President’s Day, Memorial Day, Fourth of July, Labor Day, Admission Day, Thanksgiving Day, Day after Thanksgiving Day, Christmas Day.

JOB DESCRIPTION: Excerpt from Agreement between AGC and LIUNA Local 169

The construction, erection, alteration, repair, modification, demolition, addition, improvement of all building, heavy and highway, utility, industrial and all other type(s) of construction.

SEE GROUP CLASSIFICATIONS

Craft: LUBRICATION AND SERVICE ENGINEER (MOBILE AND GREASE RACK) (Union Rate)

Prevailing wage rates include the base rate as well as all applicable fringes

Lubrication and Service Engineer (mobile and grease rack).....74.93

ADD ZONE RATE

In addition to: **LUBRICATION AND SERVICE ENGINEER (MOBILE AND GREASE RACK)** rates add the applicable amounts per hour calculated based on a road miles from the Carson City Courthouse or Washoe County Courthouse.

Zone 1	0 to 75 miles	\$0.00
Zone 2	75 to 150 miles	\$5.00
Zone 3	150 to 300 miles	\$6.00
Zone 4	300 miles and over	\$7.00

ADD PREMIUM PAY

1. One and one-half (1-1/2) times the applicable straight-time rate for the day, shift, work, equipment and classification shall be paid for all work (including repair work and field survey work) performed on Saturday and before a shift begins and after it ends, except when operating equipment servicing a craft that is receiving double time on commercial building construction, in which case double time shall be paid.
2. Overtime. The following rates shall apply on Sundays and holidays and all work before a shift begins and after it ends:

RECOGNIZED HOLIDAYS

Holidays. Double the applicable straight-time rate shall be paid for all work (including repair, maintenance and field survey work) performed on Sundays and the following holidays: New Year's Day (January 1); Memorial Day (last Monday in May); Independence Day (July 4); Labor Day (1st Monday in September); Nevada Admission Day (last Friday in October); Thanksgiving Day (4th Thursday in November); the day after Thanksgiving Day; and Christmas Day (December 25). Holidays falling on Sunday shall be observed on the following Monday. Holiday hours shall be reckoned on the same basis as Sunday hours.

Saturday Shift Period. On any shift, Saturday shall be the twenty-four-hour period commencing at 12:00 midnight Friday.

Sunday Shift Period. On any shift, Sunday shall be the twenty-four-hour period commencing at 12:00 midnight Saturday.

3. For hours worked in excess of 12) on any such workday, an Employee shall be paid two (2) times the regular straight-time rate of pay for each hour so worked.

Craft: Mechanical Insulator (Union Rate)

Prevailing wage rates include the base rate as well as all applicable fringes

Mechanical Insulator-Mechanic.....	78.46
Mechanical Insulator-Foreman.....	82.46
Mechanical Insulator-General Foreman	84.46

ADD ZONE RATE

In addition to MECHANICAL INSULATOR rates add the applicable amounts per DAY, calculated based on a radius figured from Reno City Hall:

Zone 1	0 to 20 miles	\$15.00
Zone 2	21 to 40 miles	\$25.00
Zone 3	41 to 60 miles	\$35.00
Zone 4	Over 60 miles	\$100.00
Zone 4: Up to \$140.00 per day with receipts		

ADD PREMIUM PAY

One and one half times the minimum hourly wage rate shall be paid for the first two (2) hours of overtime work, directly following eight (8) hours Monday through Friday, and for the first ten (10) hours worked on Saturdays. Double the minimum hourly wage rate shall be paid for all other overtime worked Monday through Friday and in excess of ten (10) hours on Saturdays.

RECOGNIZED HOLIDAYS

New Year's Day, President's Day, Good Friday, Memorial Day, Independence Day, Labor Day, Veteran's Day, Thanksgiving Day, Day after Thanksgiving Day, Christmas Day.

JOB DESCRIPTION: Excerpt from the Int'l Assoc. of Heat and Frost Insulators and Allied Workers Local 16 and the No. CA Chapter. Western Insulation Contractors Assoc.

- 65. Lining of all mechanical room surfaces and air handling shafts.
- 66. The filling and damming of fire stops and penetrations including, but not limited to, electrical and mechanical systems.
- 67. All foam applications for the purpose of thermal, acoustical, or fire protective purposes, including RTV foams or equivalents, applied to mechanical or electrical systems.
- 68. All duct lining, and duct wrapping, done on the job site, direct application and installation of fire protection of grease ducts, exhaust systems, or any other ductwork for acoustical or thermal purposes.
- 69. The insulation of all field joints on pre-insulated underground piping, and the pouring of Gilsilite or its equivalent.
- 70. Any finish material which is contiguous to the thermal or acoustical application.
- 71. The preparation, distribution of materials on job sites, assembling, molding, spraying, pouring, mixing, hanging, adjusting, repairing, dismantling, reconditioning, maintaining, finishing, and weather proofing of hot or cold thermal or acoustical insulation with such materials as may be specified.
- 72. The application of any material, including metal and PVC jacketing, Alumaguard or equivalent, on piping, fittings, valves, flanges, boilers, ducts, plenums, flues, tanks, vats, equipment and any other hot or cold surface for the purpose of thermal control.
- 73. The Agreement shall cover all other work of a specialty nature.

Craft: MILLWRIGHT (Union Rate)

Prevailing wage rates include the base rate as well as all applicable fringes

Millwright Journeyman.....	77.22
Millwright Welder.....	80.22
Millwright Foreman.....	81.90
Millwright General Foreman.....	87.04

ADD ZONE RATE

In addition to MILLWRIGHT rates add the applicable amounts per hour, calculated from Reno, Nevada City Hall. The Employer agrees to provide each employee zone pay as established below if the project is further than forty-five (45) miles calculated via the "shortest route" filter using Google Maps from the address of city hall of respective dispatch points.

Zone 1	Up to 45 Miles	\$0.00
Zone 2	More than 45 miles but less than 101 Miles	\$4.00
Zone 3	101 or more Miles	\$6.00

ADD PREMIUM PAY

Monday through Friday, the first four (4) hours of overtime after eight (8) hours of straight-time work shall be paid at one and one half (1½) times the straight-time rate of pay. All additional overtime will be paid at two (2) times the straight-time rate of pay.

All work performed on Sunday and Holidays shall be paid at two (2) times the straight-time rate of pay. Any work performed on Labor Day shall be paid at triple (3x) the regular straight time hourly wage rate.

Lodging: If the project is further than forty-five (45) miles calculated via the "shortest route" filter using Google Maps from the address of city hall of the respective dispatch points listed above, the Employer agrees to furnish acceptable single occupancy lodging to each employee. Employers are encouraged to use commercial facilities and lodges, however, when such facilities are not available, per diem in lieu of room and lodging shall be paid at the rate of one hundred ten dollars (\$110.00) per day, or part thereof, from the date of hire for the project to the date of termination of employment on the project.

RECOGNIZED HOLIDAYS

New Year's Day, Washington's Birthday (President's Day), Memorial Day, 4th of July, Labor Day, Veteran's Day, Thanksgiving Day, Friday after Thanksgiving, Christmas Day.

JOB DESCRIPTION Excerpt from Southwest Regional Council of Carpenters' Millwright Regional Master Construction Agreement.

Section 1.4 Millwright Jurisdiction.

The machinery, equipment, processes and associated components listed below which are identified for the purpose of description only, falls within the jurisdiction of the United Brotherhood of Carpenters and Joiners of America (Millwrights). Although some components of machinery and/or equipment may be described in one application or location and not in another, it shall not be excluded from our craft jurisdiction when, to avoid repetition, it is not described in other applications, and such jurisdiction shall be applied to the initial commissioning, maintenance, decommissioning, and recommissioning of all associated machinery and/or equipment.

Section 1.4.1

Millwright craft jurisdiction shall include the loading, unloading, hoisting, rigging by any means, transferring, moving, cleaning, disassembling, assembling, moving and setting and removal of skids, welding, burning, erecting, calibrating, precision grouting, supporting, aligning, starting-up and testing, adjusting, repairing, and the maintaining of all machinery and equipment, be it powered by, or receiving power from, steam, gas, gasoline, diesel, biodiesel,

hydrogen, jet, electric, pneumatic, magnetism, adiabatics, diabatics, isothermics, water, hydropnuematics, solar, thermal, mineral, atomic, rocket, nuclear, chemical, wind, waste product of any kind or any other source, regardless of whether or not such machinery or equipment is temporarily or permanently installed or located.

Section 1.4.2

Millwright craft jurisdiction shall include all activities necessary to: set all engines, motors, dynamos, generators, diesel generators, motor restraints and supports; install, measure and align with optical and/or electronic instruments when necessary the reactors, control, push and shut-down rods, rod pressure housing, drives, guide sleeves and other related equipment in reactors, turbines, castings, combustion chambers and all its related components; the attachment and final connection of the inlet manifolds and exhaust ducts, cylinders, diaphragms, gaskets, containment barriers, rotors, blade rings, blade or bucket assemblies, hydrogen coolers, blower assemblies, packing joints on hydrogen coolers, exciter or Alterex and all others, turning gear, extension box, welding of extension box, lagging, stretching of coupling bolts or others; perform oil flush; install turbine lube oil tank, pumps and related component skids, filters, thrust bearings, magnetic bearings, the sweating on and shrinking of bearings, couplings, shafts and others, sole plates and machine bases; perform all precision grouting using the following materials: epoxy, wet, non-shrink, dripacking or other types; perform demineralizing and hydromation; install mechanical dust systems, sensors, air compressors, super charges, coolers, boiler controls and linkage, thermal management systems, Bailey Meters or similar devices and their linkages; installation, maintenance and removal of all instrumentation, gauges, antennae and other communication devices, fluid drives, power drive trains, embedded guides for traveling screens, traveling screens, roller, slide, knife, lock and sluice gates, limit torques on mechanical valves, gates and others, tainter valves, limit switches, trips, triggers or switches, including the brackets that are attached to, stop logs, dam rollers, transfer cars and gear head motors.

Section 1.4.3

The setting of variable drives, fans, coal cranes, truck cranes or other types, including servicing and the adjusting and aligning of mechanical equipment within the cranes, crane rails and all other types of rails which would carry mechanically activated equipment, including their alignment, installation, removal, servicing, and alignment of hydraulic and pneumatic lifts and passenger boarding bridges, monorail (all sizes), magnetic propulsion systems, trolleys, pumps and their associated components, packaging equipment, refrigerating equipment, chillers, and related equipment, lantern rings, packing glands, packing for pumps, pollution equipment, carbon absorbers and filtration, heat exchanges, grain, ball, hammer, roller mills, pulverizers and others, crushers and beaters, hoppers, bins, chutes and spouts, turn tables, shears, casing machines, robots, air-veyors, conveyors of all sizes, types, and styles regardless of the materials they are constructed with, or mechanically powered conveyances of any type, including their supports, people movers, x-ray and imaging & scanning machines, elevator and platform lifts, dock levelers and locks, roll-up and sectional doors, operable partitions, retractable roofs, magnetic separators, hoists, feeding machinery, Z-loaders, S-loaders, palletizers, Triax equipment, mechanical equipment in scrubbers, pack towers, precipitators, cooling towers and air cooled condensers.

Section 1.4.4

Sewage, Brackish, Desalination, Water Treatment and Mineral Extraction Plants — the disassembly, fabricating, rigging, erecting and aligning of skimmers, rake mechanisms, feed wells, baffles, scum troughs, de-gritting equipment, bar screens, communitors, mixers, pumps, aeration systems, blowers, membrane filtration systems, sequencing batch reaction systems, including related, filter presses, sand filtration systems, ultra violet rack systems, mechanical drive assemblies, conveyors, lines, piping, flanges, brackets, supports, mono rails, gates and setting odor control and detection equipment, (excluding heating, ventilating and air conditioning work). The setting of thru-clean bar, straight line bar, trash, tritor drum, and disc screens, straight line grit, circuline grit, circuline sludge, and circuline mixer collectors, straight line, flash, horizontal slow, vertical slow, and vibra flow feeder machines, pre-aeration and settling tanks, covers for tanks, bowls and basins including stationary or mechanical covers regardless of materials, thickeners, rotoline distributors, sludge bed and settling pond cleaners, digestion systems, heaters, dyna-grind sewage screening grinders, screw pumps, spiral classifier, agitators, junk remover, hydro pulper, cooling fans, lube systems, selectifier screens, hydrosensors, fuel blowers, grizzly screens, trommels, table feeders, dryers, optical sorters, high tension separators, grip dewatering screens, flash mixer, horizontal slow mixer, vertical slow mixer, filter, cone and rotary presses, comminutors, barminutors, degreasers, rotometers, dehumidifiers, benches, pressure cleaning systems & devices, washers for cars, trucks, buses, trains, planes unmanned and autonomous vehicles and other types, hydraulic, servo and pneumatic units, shroud boxes, silencers, scales, load cells, eddy current clutches, disintegrators, dehairing machines, grain handling devices, laboratory equipment, machine shop equipment, ladle cars, stunning pens and doors and gates, activation equipment, racks, material handling platforms, access & egress platforms, catwalks,

transition pieces, the handling and installation, of pulleys, gears, fluid couplings, sheaves and fly wheels, air vacuum, worm, belt, friction, rope, magnetic, chain and gear drives that are directly or indirectly coupled to motors, belts, chains, shafts, or screws, installation of legs, boots, guards and boot tanks, all bin and diverter valves, turn hands and indicators, shafting, bearing cable sprockets, cutting of all key seats in old and new work, troughs, chippers, calenders, rolls, winders, rewinders, slitters, cutters, wrapping machines, blowers, forging machines, pneumatic, electric and hydraulic rams, servo actuators, extractors, expellers and extruders, ball and dust collectors, splicing of ropes and cables.

Millwright craft jurisdiction on energy generation facilities shall include all loading, unloading, movement, hoisting, preparation, uncrating, preparation of nacelle units prior to installation or removal, installation, setting, removal, alignment, and final torquing and tensioning of any mechanical component used in the generation of power, including any incidental wiring or piping. This shall include all aspects of power trains, drive and tracking systems, elevation and azimuth drives, energy collection optimization systems, all rams, dampers and other stabilization devices, antennae, bearing housing assemblies and units, actuators, pulleys, gears, access points, rotational connections, mounting and alignment of tracks, axles, bearings, rotational joints, or any other device which allows for the automated or manual movement of equipment post-installation, all turbines, and wind, wave and tidal analysis equipment. It shall also include all work associated with energy collection and storage facilities, including the loading, unloading, movement, hoisting, preparation, installation, setting, and alignment of racking systems, torque tubes, modules, batteries, energy storage systems, cooling or control systems, inertia systems or other equipment or machinery, and all incidental wiring or piping thereof.

Section 1.4.5

The laying out, fabrication and installation of protecting equipment including: machinery guards; the making and setting of templates for machinery; the fabrication of bolts, nuts, pans; the drilling or creating of holes in machinery for any equipment which the Millwrights install, remove, service or inspect, regardless of material; installation of all methods of access and egress and safety devices whether temporary or permanent; all welding and burning regardless of type; the fabrication of all lines, hose or tubing used in the lubrication, operation, cooling or heating of machinery, including the installation of all fluids used to operate, lubricate, cool or heat equipment installed by Millwrights; the cleaning or pressure cleaning of machinery; the machining, grinding, milling, broaching, boring, threading, lapping, field machining, technical bolting and keying that may be necessary for any part of equipment, including the starting up, breaking in, trial running and operational or functional testing of any equipment or machinery installed or handled by the Millwrights, the initial programing of robotics for startup, and the incidental connection and disconnection of machinery and equipment from piping and electrical systems.

Section 1.4.6

Rock, sand and gravel plants, mineral processing plants and batch or aggregate plants: Installation, removal and maintenance of all recycling equipment, separators, centrifuges, classifiers, grates, crushers, conveyors, chutes or piping from one piece of mechanical equipment into another piece of mechanical equipment, or from a vessel into a conveyor, or into other places or mechanical equipment or other mechanical equipment used (for the purpose of description only) to excavate material from one area to another from highways, roadways, waterways or elsewhere.

Section 1.4.7

When optical instruments such as total stations or similar devices, automatic levels, builder's transits, precision jig transits, tilting levels, theodolites or other precision tools and instruments are used to locate, set, scan-to-BIM or as-Built measure and verify machines, these tools are considered a tool of the Millwright trade and are to be used by Millwrights to set the equipment or machinery.

Section 1.4.8

Incidental asbestos removal on equipment in which Millwrights normally remove during maintenance and repair work.

Section 1.4.9

Any new equipment or technology designed to replace any of the equipment described above shall remain in the craft jurisdiction of the Millwrights.

Craft: OPERATING ENGINEER (Union Rate)

Prevailing wage rates include the base rate as well as all applicable fringes

Operating Engineers	(SEE GROUP CLASSIFICATIONS)
Group 1.....	69.91
Group 1A.....	72.67
Group 2.....	73.20
Group 3.....	73.47
Group 4.....	74.21
Group 5.....	74.51
Group 6.....	74.68
Group 7.....	74.93
Group 8.....	75.52
Group 9.....	75.84
Group 10.....	76.19
Group 10A.....	76.38
Group 11.....	76.62
Group 11A.....	78.26
Group 11B.....	79.07
Foreman.....	78.26

Add 12.5% to base rate for "Special" Shift

Add Operating Engineers Zone Pay

Add Premium Pay

Craft: OPERATING ENGINEER (Union Rate)
STEEL FABRICATOR & ERECTOR

Prevailing wage rates include the base rate as well as all applicable fringes

Operating Engineers	(SEE GROUP CLASSIFICATIONS)
Group 1.....	85.21
Group 1 Truck Crane Oiler.....	79.04
Group 1 Oiler.....	77.08
Group 2.....	83.70
Group 2 Truck Crane Oiler.....	78.79
Group 2 Oiler.....	76.87
Group 3.....	82.46
Group 3 Truck Crane Oiler.....	78.57
Group 3 Oiler.....	76.65
Group 3 Hydraulic.....	78.24
Group 4.....	80.73
Group 5.....	79.63

Add 12.5% to base rate for "Special" Shift

Add Operating Engineers Zone Pay

Add Premium Pay

Craft: OPERATING ENGINEER (Union Rate)
PILEDRIVER

Prevailing wage rates include the base rate as well as all applicable fringes

Operating Engineers	(SEE GROUP CLASSIFICATIONS)
Group 1.....	84.68
Group 1 Truck Crane Oiler.....	79.22
Group 1 Oiler.....	77.30
Group 2.....	83.14
Group 2 Truck Crane Oiler.....	79.01
Group 2 Oiler.....	77.10
Group 3.....	81.69
Group 3 Truck Crane Oiler.....	78.79
Group 3 Oiler.....	76.87
Group 4.....	80.18
Group 5.....	79.07
Group 6.....	75.79
Group 7.....	77.00
Group 8.....	76.04
Add 12.5% to base rate for "Special" Shift	

ADD ZONE RATE

In addition to: **OPERATING ENGINEER, STEEL FABRICATOR & ERECTOR, and OPERATING ENGINEER PILEDRIIVER**, rates add the applicable amounts per hour calculated based on a road miles from the Carson City Courthouse or Washoe County Courthouse

Zone 1	0 to 75 miles	\$0.00
Zone 2	75 to 150 miles	\$5.00
Zone 3	150 to 300 miles	\$6.00
Zone 4	300 miles over	\$7.00

ADD PREMIUM PAY

1. One and one-half (1-1/2) times the applicable straight-time rate for the day, shift, work, equipment and classification shall be paid for all work (including repair work and field survey work) performed on Saturday and before a shift begins and after it ends, except when operating equipment servicing a craft that is receiving double time on commercial building construction, in which case double time shall be paid.

2. Overtime. The following rates shall apply on Sundays and holidays and all work before a shift begins and after it ends:

RECOGNIZED HOLIDAYS

Holidays. Double the applicable straight-time rate shall be paid for all work (including repair, maintenance and field survey work) performed on Sundays and the following holidays: New Year's Day (January 1); Memorial Day (last Monday in May); Independence Day (July 4); Labor Day (1st Monday in September); Nevada Admission Day (last Friday in October); Thanksgiving Day (4th Thursday in November); the day after Thanksgiving Day; and Christmas Day (December 25). Holidays falling on Sunday shall be observed on the following Monday. Holiday hours shall be reckoned on the same basis as Sunday hours.

Saturday Shift Period. On any shift, Saturday shall be the twenty-four-hour period commencing at 12:00 midnight Friday.

Sunday Shift Period. On any shift, Sunday shall be the twenty-four-hour period commencing at 12:00 midnight Saturday.

3. For hours worked in excess of 12) on any such workday, an Employee shall be paid two (2) times the regular straight-time rate of pay for each hour so worked.

JOB DESCRIPTION, includes but is not limited to:

Operate one or several types of power construction equipment, such as motor graders, bulldozers, scrapers, compressors, pumps, derricks, shovels, tractors, or front-end loaders to excavate, move, and grade earth, erect structures, or pour concrete or other hard surface pavement.

Craft: PAINTER (Union Rate)

Prevailing wage rates include the base rate as well as all applicable fringes

Brush/Roller Painter.....	53.14
Spray Painter/Paperhanger.....	55.72
Sandblaster.....	55.14
Structural Steel & Steeplejack.....	55.14
Swing Stage.....	55.64
Special Coating Application-Brush.....	55.14
Special Coating Application-Spray.....	55.14
Special Coating Application-Spray Steel.....	55.14
Foreman.....	\$2.50 above highest Journeyman

ADD PREMIUM PAY

One and one half (1 ½) the regular straight time hourly rate shall be paid:

1. For all hours worked over eight (8) hours in one day or shift unless the Union is notified when four (4) tens (10's) are instituted.
2. For any hours worked on Saturday from midnight to midnight
3. For any work performed in excess of the regular work week of forty (40) hours.

Double the regular straight time hourly rate shall be paid for all time:

1. For any hours worked on Sunday from midnight to midnight
2. For any hours worked on holidays from midnight to midnight

RECOGNIZED HOLIDAYS

New Year's Day, President's Day, Memorial Day, Independence Day, Labor Day, Veteran's Day, Thanksgiving Day, Day after Thanksgiving Day, Christmas Day.

JOB DESCRIPTION: Excerpt from Agreement between Painters and Allied Trades DC 16 and Independent Painting Contractors of No Nevada.

a. All painting of residences, buildings, structures, industrial plants, tanks, vats, pipes, vessels, bridges, light poles, high tension poles, traffic and parking lines on highways, parking lots, playgrounds, factories, and air line strips; all sign, pictorial, coach, car automobile, carriage, aircraft machinery, ship and railroad equipment, mural and scenic painting; spackling of all surfaces where adhesive materials are used; and all drywall pointing, taping and finishing.

b. All decorators, paperhangers, hard wood finishers, grainers, glaziers, varnishers, enamellers

1. Paperhangers work shall be all material of whatever kind or quality applied to walls or ceilings with paste or adhesive; all tacking on the muslin or other materials which is used as wall or ceiling coverings or covered with material pasted on.

2. The scraping off of old paper, preparing of walls, etc., for paper hangers work.

3. The application of relief, stucco, plaster or decorative work shall not be considered paperhanger's work exclusively.

(c) All men engaged in applying or removing paints, pigments, extenders, metal primers and metal pigments, clear pigments, binders, thinners and dryers, primers and sealers, oil paints and enamels, water

colors and emulsions, clear coatings, waxes, stains, mastics, cement enamels and other special coatings, plastics, adhesives, coatings and sheet rubber and other linings, oils, varnishes, water colors, wall paper, wall coverings or other materials used in the various branches of the trade, and the cleaning and bleaching of all interior and exterior walls and surfaces with liquid, steam, sandblast or any other process and all work incidental thereto.

Craft: PILEDRIVER (Union Rate)

Prevailing wage rates include the base rate as well as all applicable fringes

Piledriver-Journeyman.....	61.92
Piledriver-Welder.....	62.92
Piledriver-Foreman.....	65.81
Piledriver-General Foreman.....	70.09
Tender.....	65.81
Stand-By Diver.....	66.81
Diver-Diving (Wet Pay).....	110.58

ADD ZONE RATE

In addition to PILEDRIVER rates add the applicable amounts per hour, calculated from the Washoe County Courthouse:

Zone 1	Within 75 miles	\$0.00
Zone 2	Between 75 to 150 road miles	\$6.00
Zone 3	Between 150 to 300 road miles	\$7.00
Zone 4	In excess of 300 road miles	\$8.00

Workmen performing outside of the free zones shall receive the appropriate remote area allowance for not less than eight (8) hours per day. Remote area differential shall be considered part of the basic wage rate for the purpose of computing overtime hourly wage rates.

ADD PREMIUM PAY

First two (2) hours outside the regular constituted shift shall be at the rate of time and one-half (1½X). Saturdays up to the first twelve (12) hours shall be at the rate of time and one-half (1½X). All additional hours and Sundays and holidays shall be the rate of double time (2X). No work shall be performed on Labor Day, except to preserve life and property.

RECOGNIZED HOLIDAYS

New Year's Day, Memorial Day, 4th of July, Labor Day, Admission Day, Thanksgiving Day, the Friday after Thanksgiving, Christmas Day.

JOB DESCRIPTION

104.1 The Carpenters claim the layout, rigging, tagging, signaling, cutting, burning, welding, chain sawing, driving, setting and pulling of all soldier piles and soldier beams together with all necessary waling, shoring, underpinning, struts, bracing, capping and lagging necessary for construction of subterranean structures of all types to include, but not limited to subways, subway stations, buildings, storm drains, sewers, pipelines and all open cut and cover construction projects. The Carpenters further claim construction of all covers and access mats to include all necessary rigging for setting and removing, whether intermittently or regularly and installation and removal of timber decking.

(a) In addition to the work identified in Article I, the Pile Divers claim the operation of the following types of equipment when the operation of same is incidental to that work which falls under the jurisdiction of the United Brotherhood of Carpenters and Joiners of America or Pile Drivers Local Union No. 2375; mechanical forklifts of all types, boom trucks and any other mobile equipment as assigned by the employer necessary to complete the work. In addition, the operation of the power pack and vibratory hammer controls when driving or pulling, sheet pile, pile, soldier beams, cassinos or casing. . The work includes work on cast & drill holes and operation of the ABI machine.

(1) In the construction of waterfront and marine facilities, such as docks, piers, wharves, bulkheads, jetties, and similar structures, the pile driver classification should continue to apply, up to and including the decking thereof.

- (2) On all pile driving and caisson work on both land and water, the Pile Driver classification should apply.
- (3) In the construction of wooden bridges whether over land or over water, when composed of heavy timber, the Pile Driver classification should apply.
- (4) In the construction of concrete or steel bridges over land, the Pile Driver classification shall apply to the driving of piles and/or caisson work including the forms required for the capping of the piles or caissons immediately top of the piles or caissons. The capping of the piles is herein interpreted as being that concrete, wood, or other material resting on the top of the piles where driven or placed and does not include any further form work above the capping. In many instances it has been found that the capping is called the girder. The above shall apply on such concrete or steel bridges constructed over land, highways, railroads, overpasses and include cloverleafs, interchanges, etc.
- (5) In the construction of concrete or steel bridges over water, the Pile Driver classification shall apply up to and including all of the form work to the top of the column, piers, or abutments supporting the steel and/or any other superstructures.
- (6) In the erection of false work, when necessary for the support of work under the Pile Driver classification, then such false work shall fall within their classification. False work necessary for the support of work under the Carpenter classification shall be done within such Carpenter classification, with the exception that where pile driving or power equipment is used for heavy timber false work, then such work shall come under the Pile Driver classification. This would include all rigging, signaling and tagging incidental to the placing of the heavy timber.
- (7) In the construction of open-cut sewers, the Pile Driver classification shall apply on all piling including wood, steel or concrete sheet piling, all bracing timber and form work incidental to the construction thereof.

Craft: PLASTERER (Union Rate)

Prevailing wage rates include the base rate as well as all applicable fringes

Plasterer-Journeyman.....	55.62
Plasterer-Foreman.....	59.57

ADD ZONE RATE

In addition to PLASTERER rates add the applicable amounts per hour, calculated from the South Virginia and Mill Street, Reno, Nevada:

Zone 1	0 to 70 miles	\$0.00
Zone 2	70 miles and over	\$8.00

ADD PREMIUM PAY

OVERTIME: Eight (8) consecutive hours (exclusive of a meal period) shall constitute a day's work at straight time. Five (5) consecutive days of eight (8) consecutive hours (exclusive of a meal period), Monday through Friday, shall constitute a week's work. One and one half (1 ½) the regular straight time hourly rate shall be paid for the first two (2) hours worked over eight (8) hours Monday through Friday. Double the regular straight time rate shall be paid for all hours worked over ten (10) hours Monday through Friday. One and one half (1 ½) the regular straight time rate shall be paid for the first ten (10) hours on Saturday. Double the regular straight time rate shall be paid for all hours worked over ten (10) hours on Saturday. All hours worked on Sunday shall be paid at double the regular straight time rate.

RECOGNIZED HOLIDAYS

All work performed on the following holidays shall be paid for at double the regular straight time rate: New Year's Day, Memorial Day, Fourth of July, Labor Day, Admissions Day, Thanksgiving Day and the Friday after Thanksgiving and also Christmas Day.

If any of the above holidays fall on Sunday, the Monday following shall be considered a holiday.

No work shall be permitted on the Fourth of July or Labor Day, regardless of compensation or donation, except in case of emergency or to protect life and property. Permission to work shall be granted by the representative of the Union or its officer.

JOB DESCRIPTION: Excerpt from Agreement No NV. Plasterers Master Labor Agreement

This includes but is not limited to:

1. All building construction, including but not limited to the construction, erection, alteration, repair,modification, demolition, addition, or improvement in whole or in part of any building structures.
2. All interior or exterior plastering construction, restoration, repair and inspection of cement, stucco, stone imitation or any patent material when ornamental molded plaster, and the setting of same. All specialty finishes such as veneer, venetian, marmoreno and grasello. All custom and specialty finishes, including but not limited to custom rock, carved plaster, brick and block veneer, stone and wood. Smooth and finish surfaces of full system E.I.F.S. including sticking and shaping of foam pieces or surfaces by adhesive or mechanical installation. All spray or toweled on fireproofing, including cementitious and intumescent products. All plaster acoustical finish systems including, but not limited to, BASWA Phon and Fellert.
3. All work processes which represent technological change, replacement, modification or substitution for the work described above. In addition, all work and use of new materials or *2020-2024 Reno Plasterers Master Labor Agreement* 4 techniques involved in plaster construction including but not limited to what is known as green or sustainable construction technology.

Craft: PLUMBER/PIPEFITTER (Union Rate)

Prevailing wage rates include the base rate as well as all applicable fringes

Plumber/Pipefitter-Journeyman.....	76.10
Plumber/Pipefitter-Foreman.....	81.19
Plumber/Pipefitter-General Foreman.....	86.28

ADD ZONE RATE

In addition to PLUMBER/PIPEFITTER rates add the applicable amounts per statute air mile radius from the Nevada freeway interchange of Interstate 80 and 580.

Zone 1	0 to 75	\$0.00
Zone 2	Over 75 miles	\$8.00

A separate free zone will be established for employees permanently residing and working within a seventy-five (75) statute air mile radius of the Elko, Nevada Post Office.

Zone 1	0 to 75	\$0.00
Zone 2	Over 75 miles	\$8.00

ADD PREMIUM PAY

Premium pay for hours worked in excess of a shift of 8 hours or 12 hours or such other time increment set forth in the Collective Bargaining Agreement or on a weekend or holiday.

RECOGNIZED HOLIDAYS

New Year's Day, Memorial Day, Fourth of July, Labor Day, Nevada Admission Day, Thanksgiving Day, the Friday after Thanksgiving Day, Day Before Christmas and Christmas Day and any Friday preceding a Holiday falling on a Saturday, if worked, holidays shall be compensated at the double time rate.

JOB DESCRIPTION Excerpt from Agreement between LU 350 of United Assoc. of Journeymen and Apprentices of the Plumbing and Pipefitting Industry of United States and Canada

Installation of all heating and refrigeration systems and competent parts thereof, including fabrication, assembling, erection installation, dismantling, repairing, reconditioning, adjusting, altering servicing, handling, distributing, and tying on all piping materials appurtenances and equipment by method, including all hangars and supports of every description, all other work including the the trade relevant to oil burner and all other types of heating and refrigeration equipment including low voltage controls.

Craft: REFRIGERATION MECHANIC (Union Rate)

Prevailing wage rates include the base rate as well as all applicable fringes

Refrigeration-Journeyman.....	67.14
Refrigeration -Foreman.....	67.64

ADD PREMIUM PAY

Premium pay for hours worked in excess of a shift of 8 hours or 12 hours or such other time increment set forth in the Collective Bargaining Agreement or on a weekend or holiday.

RECOGNIZED HOLIDAYS

New Year's Day, Memorial Day, Fourth of July, Labor Day, Nevada Admission Day, Thanksgiving Day, the Friday after Thanksgiving Day, Day Before Christmas and Christmas Day and any Friday preceding a Holiday falling on a Saturday, if worked, holidays shall be compensated at the double time rate.

JOB DESCRIPTION Excerpt from Agreement between LU 350 of United Assoc. of Journeymen and Apprentices of the Plumbing and Pipefitting Industry of United States and Canada

Installation of all heating and refrigeration systems and competent parts thereof, including fabrication, assembling, erection installation, dismantling, repairing, reconditioning, adjusting, altering servicing, handling, distributing, and tying on all piping materials appurtenances and equipment by method, including all hangars and supports of every description, all other work including the trade relevant to oil burner and all other types of heating and refrigeration equipment including low voltage controls.

Craft: ROOFER (Non-Union Rate)
(Does not include sheet metal roofs)

Prevailing wage rates include the base rate as well as all applicable fringes

Rofer-Journeyman.....33.64

JOB DESCRIPTION

Includes but is not limited to:

1. Installing and covering roofs and structures with slate, asphalt, wood and other related materials, other than sheet metal, by using brushes, knives, punches, hammers and other tools;
2. Spraying roofs, sidings and walls with material to bind, seal, insulate or soundproof sections of a structure;
3. Installation of all plastic, slate, slag, gravel, asphalt and composition roofing, and rock asphalt mastic when used for damp and waterproofing;
4. Installation of all damp resisting preparations when applied on roofs with mop, three-knot brush, roller, swab or spray system;
5. All types of preformed panels used in waterproofing;
6. Handling, hoisting and storing of all roofing, damp and waterproofing materials;
7. The tear-off and/or removal of roofing and roofing materials.

Craft: SHEET METAL WORKERS (Union Rate)

Prevailing wage rates include the base rate as well as all applicable fringes

Sheet Metal Worker Journeyman.....	77.37
Sheet Metal Worker -Foreman.....	82.06
Sheet Metal Worker -General Foreman.....	86.75

ADD ZONE RATE

A separate free zone will be established for employees permanently residing and working within a seventy-five (75) mile radius of the Elko, Nevada Post Office. In addition to SHEET METAL rates add the applicable amounts per hour, calculated based on a road from the courthouse in Reno, Nevada:

Zone 1	0 to 75 miles	\$0.00
Zone 2	75 to 100 miles	\$5.00
Zone 3	Over 100 miles	\$10.00 the employee shall be provided reasonable lodging and meal expenses.

ADD PREMIUM PAY

All hourly rates are subject to Over Time (One and one half 1 ½) of the Regular rate:

1. For all hours worked over Eight (8) Hours in one day or shift.
2. For the first Eight (8) Hours work on Saturday.

All hourly rates are subject to Double Time of the Regular Rate:

1. For all hours worked over Ten (10) Hours in one day or shift.
2. For all hours worked over Eight (8) Hours on Saturday.
3. For all hours worked on Sunday, New Year’s Day, Memorial Day, Independence Day, Friday before Labor Day, Labor Day, Nevada Day, Thanksgiving Day, Day after Thanksgiving, Day before Christmas, and Christmas Day.

RECOGNIZED HOLIDAYS

New Year’s Day, Memorial Day, Independence Day, Friday before Labor Day, Labor Day, Nevada Day, Thanksgiving Day, Day after Thanksgiving, Day before Christmas, and Christmas Day

JOB DESCRIPTION: Excerpt from Sheet Metal Local 26 Collective Bargaining Agreement

(a) manufacture, fabrication, assembling, handling, erection, installation, dismantling, conditioning, adjustment, alteration, repairing and servicing of all ferrous or nonferrous metal work and all other materials used in lieu thereof and of all HVAC systems, air veyor systems, exhaust systems, and air-handling systems regardless of material used including the setting of all equipment and all reinforcements in connection therewith; (b) all lagging over insulation and all duct lining; (c) testing and balancing of all air-handling equipment and duct work; (d) the preparation of all shop and field sketches whether manually drawn or computer assisted used in fabrication and erection, including those taken from original architectural and engineering drawings or sketches; (e) metal exterior wall systems, metal roofing; and (f) all other work included in the jurisdictional claims of International Association of Sheet Metal, Air, Rail and Transportation Workers.

Craft: SOILS and MATERIAL TESTER (Non-Union Rate)

Prevailing wage rates include the base rate as well as all applicable fringes

Soil Tester (Certified).....	46.81
Soils and Materials Tester.....	46.81

Craft: SPRINKLER FITTER (Union Rate)

Prevailing wage rates include the base rate as well as all applicable fringes

Sprinkler Fitter-Journeyman.....	65.31
Sprinkler Fitter Foreman.....	68.31
Sprinkler Fitter General Foreman.....	70.56

ADD ZONE RATE

In addition to SPRINKLER FITTER rates add the applicable amounts per hour, calculated based on a road from the courthouse in Reno, Nevada:

Zone 1	0 to 60 miles	\$0.00
Zone 2	60 to 80 miles	\$23.00
Zone 3	80 to 100 miles	\$33.00
Zone 4	Over 100 miles	\$125.00

JOB DESCRIPTION

Installing, dismantling, maintenance, repairs, adjustments and corrections of all fire protection and fire control systems including the unloading, handling by hand, power equipment and installation of all piping or tubing, appurtenances and equipment pertaining thereto, including both overhead and underground water mains, fire hydrants and hydrant mains, standpipes, and hose connections to sprinkler systems, sprinkler tank heaters, air lines and thermal systems used in connection with sprinkler and alarms systems, also all tanks and pumps connected thereto. Also including shall be CO2 and Cardox Systems, Dry Chemical Systems, Foam Systems and all other fire protection systems, but excluding steam fire protection systems.

Craft: SURVEYOR (Union Rate)

Prevailing wage rates include the base rate as well as all applicable fringes.

Rodman/Chainman	72.97
Instrumentman.....	74.43
Chief of Party Surveyor.....	75.69

ADD ZONE RATE

In addition to: **OPERATING ENGINEER, STEEL FABRICATOR & ERECTOR, and OPERATING ENGINEER PILEDRIVER**, rates add the applicable amounts per hour calculated based on a road mile from the Carson City Courthouse or Washoe County Courthouse

Zone 1	0 to 75 miles	\$0.00
Zone 2	75 to 150 miles	\$5.00
Zone 3	150 to 300 miles	\$6.00
Zone 4	300 miles over	\$7.00

ADD PREMIUM PAY

1. One and one-half (1-1/2) times the applicable straight-time rate for the day, shift, work, equipment and classification shall be paid for all work (including repair work and field survey work) performed on Saturday and before a shift begins and after it ends, except when operating equipment servicing a craft that is receiving double time on commercial building construction, in which case double time shall be paid.

2. Overtime. The following rates shall apply on Sundays and holidays and all work before a shift begins and after it ends:

Saturday Shift Period. On any shift, Saturday shall be the twenty-four-hour period commencing at 12:00 midnight Friday.

Sunday Shift Period. On any shift, Sunday shall be the twenty-four-hour period commencing at 12:00 midnight Saturday.

3. For hours worked in excess of 12 on any such workday, an Employee shall be paid two (2) times the regular straight-time rate of pay for each hour so worked.

RECOGNIZED HOLIDAYS

Holidays. Double the applicable straight-time rate shall be paid for all work (including repair, maintenance and field survey work) performed on Sundays and the following holidays: New Year's Day (January 1); Memorial Day (last Monday in May); Independence Day (July 4); Labor Day (1st Monday in September); Nevada Admission Day (last Friday in October); Thanksgiving Day (4th Thursday in November); the day after Thanksgiving Day; and Christmas Day (December 25). Holidays falling on Sunday shall be observed on the following Monday. Holiday hours shall be reckoned on the same basis as Sunday hours.

JOB DESCRIPTION includes but is not limited to:

1. Planning ground surveys designed to establish base lines, elevation and other geodetic measurements;
2. Compiling data relevant to the shape, contour, gravitation, location, elevation and dimension of land and land features on or near the surface of the Earth for engineering, map making, mining, land evaluation, construction and other purposes;
3. Surveying bodies of water to determine navigable channels and to secure data for construction of breakwaters, piers and other marine structures;
4. Computing data necessary for driving and connecting underground passages, underground storage and volume of underground deposits.

Craft: TAPER (Union Rate)

Prevailing wage rates include the base rate as well as all applicable fringes

Taper-Journeyman.....	59.26
Taper-Foreman.....	63.54

ADD ZONE RATE

In addition to: TAPER rates add the applicable amounts per hour Zone Pay shall commence from the Washoe County Courthouse in Reno, Nevada, and shall be paid as follows:

Zone 1	0 to 40 miles	\$0.00
Zone 2	40 to 60 miles	\$2.50
Zone 3	over 60 miles	\$4.25

RECOGNIZED HOLIDAYS

New Year's Day, President's Day, Memorial Day, Independence Day, Labor Day, Veteran's Day, Thanksgiving Day, Day after Thanksgiving Day, Christmas Day. When holiday falls on a Sunday, the Monday following shall be observed as the holiday; holidays falling on Saturday shall be observed on the prior Friday.

ADD PREMIUM PAY

All overtime, except Sundays and holidays, will be time and one-half (1 1/2). Sundays and holidays will be paid double time (2X). Any and all work performed in excess of the regular workday of eight (8) hours, or ten (10) hours if mutually agreed to, and the regular workweek of forty (40) hours shall be considered overtime and shall be paid for at one and one-half (1 1/2) times the regular hourly rate.

JOB DESCRIPTION: Excerpt from Agreement between DC 16 and the independent Drywall Contractors of Northern Nevada

SECTION 1 -- The scope of work covered by this Agreement shall include (but not be limited to) all work operations, including distribution to the point of application, as follows:

- (a) Work or services pertaining to the preparation, spotting, pointing, detailing, flushing, sanding and finishing of interior and/or exterior gypsum, drywall, thin wall, concrete, steel, wood and plaster surfaces, spackling of all surfaces where adhesive materials are used; and all drywall pointing, taping and finishing.
- (b) Work or services pertaining to the application of all finish or flushing materials regardless of method of application or type of surface on which materials are applied, including but not limited to texture and simulated acoustic materials of all types and the application of radiant heat fill and steel fireproofing materials.
- (c) Work or services pertaining to the installation of protective coverings and masking prior to the application of finish materials.
- (d) The operation and care of all taping tools and texturing equipment used in the finishing and texturing of drywall and other surfaces including brushes, rollers, spray texturing equipment, miscellaneous hand, mechanical, and power tools, and the operation and maintenance of compressors required in the finishing and texturing of such surfaces.
- (e) No limitation shall be placed on the work covered by this Agreement by reason of the surface, type of material or purpose for which the materials used are designed or intended.
- (f) The cleanup of all materials and debris occasioned by any job operation at the site of construction, alteration, or repair undertaken whether such operation occurs on the interior or exterior of a building structure.

Craft: TILE SETTER/TERRAZZO WORKER/MARBLE MASON FINISHER (Union Rate)

Prevailing wage rates include the base rate as well as all applicable fringes

Tile Setter/Terrazzo Worker/Marble Mason - Finisher.....	42.32
Tile Setter/Terrazzo Worker/Marble Mason - Finisher Foreman.....	44.32
Tile Setter/Terrazzo Worker/Marble Mason Finisher- General Foremen.....	68.32

ADD ZONE RATE

In addition to TILE/TERRAZZO WORKER/MARBLE MASON FINISHER wage rates, employees shall receive the following hourly zone pay for all jobs located more than forty (40) miles from the Washoe County Courthouse in Reno, Nevada:

Zone 1	0 to 40 miles	\$0.00
Zone 2	40 to 50 miles	\$3.75
Zone 3	50 to 70 miles	\$5.00
Zone 4	Over 70 miles	\$10.00

ADD PREMIUM PAY

All work in excess of forty (40) hours during the established work week shall be paid at the rate of one and one-half (1-1/2) times the hourly base wage rate in effect.

Employees shall be paid one and one-half (1-1/2) times the hourly wage rate for all hours worked over eight (8) in a single day and double time after ten (10) hours in a single day, Monday through Friday, except recognized holidays.

Daily Overtime Saturdays the first ten (10) hours performed on Saturday shall be paid at one and one-half (1-1/2) times the straight time wage rate.

Daily Overtime Sunday- Employees shall be paid double time on Sundays if forty (40) straight time hours have been worked during the proceeding work week.

Holidays shall be paid double time for hours owed on recognized holidays.

RECOGNIZED HOLIDAYS

New Year's Day, President's Day, Memorial Day, Independence Day, Labor Day, Veteran's Day, Thanksgiving Day, Day after Thanksgiving Day, Christmas Day. Any holiday falling on a Sunday will be observed on Monday.

JOB DESCRIPTION: Excerpt from Agreement between BAC 13 Nevada of the Mountain West Administrative District Council Master Labor Agreement

FINISHER'S WORK:

Finisher's work shall consist of assisting, helping or supporting the tile, marble and terrazzo mechanic by performing their historic and traditional work assignments. required to complete the proper installation of the work covered by Sections 5, 7 and 8 of this Code.

Craft: TILE SETTER/TERRAZZO WORKER/MARBLE MASON (Union Rate)

Prevailing wage rates include the base rate as well as all applicable fringes

Tile Setter - Journeyman.....	52.37
Tile Setter - Foreman.....	54.37
Tile Setter - General Foreman.....	58.37
Terrazzo/Marble Mason - Journeyman	53.87
Terrazzo/Marble Mason - Foreman	55.87
Terrazzo/Marble Mason - General Foreman.....	59.87

ADD ZONE RATE

In addition to TILE SETTER/TERRAZZO/MARBLE MASON wage rates, employees shall receive the following hourly zone pay for all jobs located more than forty (40) miles from the Washoe County Courthouse in Reno, Nevada:

Zone 1	0 to 40 miles	\$0.00
Zone 2	40 to 50 miles	\$3.75
Zone 3	50 to 70 miles	\$5.00
Zone 4	Over 70 miles	\$10.00

ADD PREMIUM PAY

All work in excess of forty (40) hours during the established work week shall be paid at the rate of one and one-half (1-1/2) times the hourly base wage rate in effect.

Employees shall be paid one and one-half (1-1/2) times the hourly wage rate for all hours worked over eight (8) in a single day and double time after ten (10) hours in a single day, Monday through Friday, except recognized holidays.

Daily Overtime Saturdays the first ten (10) hours performed on Saturday shall be paid at one and one-half (1-1/2) times the straight time wage rate.

Daily Overtime Sunday- Employees shall be paid double time on Sundays if forty (40) straight time hours have been worked during the proceeding work week.

Holidays shall be paid double time for hours owed on recognized holidays.

RECOGNIZED HOLIDAYS

New Year's Day, President's Day, Memorial Day, Independence Day, Labor Day, Veteran's Day, Thanksgiving Day, Day after Thanksgiving Day, Christmas Day. Any holiday falling on a Sunday will be observed on Monday.

JOB DESCRIPTION: Excerpt from Agreement between BAC 13 Nevada of the Mountain West Administrative District Council Master Labor Agreement

TILE LAYERS' WORK:

Tile laying shall consist of, but not be limited to, the following work procedures and installation of the following materials:

A. The laying, cutting or setting of all tile where used for floors, walls, ceilings, walks, promenade roofs, stair treads, stair risers, facings, hearths, fireplaces, and decorative inserts, together with any marble plinths, thresholds or window stools used in connection with any tile work; also, preparing and setting all concrete, cement, brickwork, or other foundation or materials that may be required to properly set and complete such work; setting or bedding all tiling, stone, marble, composition, glass, mosaic, or other materials forming the facing, hearth or fireplace of a mantel, or the mantel complete, together with setting of all cement, brickwork, or other materials required in connection with the above work; also the slabbing and fabrication of tile mantels, counters and tile panels of every description, and the erection and installation of same; the building, shaping, forming, construction or repairing of all fireplace work, whether in connection with a mantel hearth facing or not, and the setting and preparing of all material, such as cement, plaster, mortar, brickwork, iron work or other materials necessary for the proper and safe construction and completion of such work, except that a mantel made exclusively of brick, marble or stone, shall be conceded to be bricklayers', marble setters' or stonemasons' work, respectively.

B. It will be understood that the word "tile" refers to all burned clay products, as used in the tile industry, either glazed or unglazed, and to all composition materials made in single units up to 15"x20"x2", except quarry tiles larger than 9"x9"x1 1/4", also to mixtures in tile form of cement, plastics and metals that are made for and intended for use as a finished floor surface, whether upon interior or exterior floors, stair treads, promenade roofs, garden walks, interior walls, ceilings, swimming pools, and all places where tile may be used to form a finished surface for practical use, sanitary finish or decorative purposes, for setting all accessories in connection therewith, or for decorative inserts in other materials.

C. All terra cotta called unit tile in sizes of 6"x12" or under, regardless of method of installation, quarry tile 9"x9"x1 1/4" or less; split brick or quarry tile or similar material where the bed is floated or screeded and the joints grouted. Where the work is installed by tile layers, the grouting and cleaning shall be supervised by the mechanic. The bedding, jointing, and pointing of the above materials shall be the work of the craft installing the same. All clay products known as terra cotta tile, unit tile, ceramic veneer and machine-made terra cotta, and like materials in sizes 6"x12" and less regardless of the method of installation. Where the preponderance of materials to be installed comes within the provisions of this Section and when there is also some material in excess of the sizes provided for in this Section, the tile setter shall install all such materials.

D. The preparation, setup, calibration, operation, cleaning, and routine maintenance of any mechanical devices or robotics used to install tile and related materials, or that otherwise assist the tile layer in performing any of the work described in Article II and Code 1 of the IU Constitution, as well as the preparation and ongoing maintenance of the work area to allow proper installation of tile and related materials.

Craft: TRAFFIC BARRIER ERECTOR (Union Rate)

Prevailing wage rates include the base rate as well as all applicable fringes

Traffic Barrier Erector.....50.78

ADD ZONE RATE

In addition to LABORER rates add the applicable amounts per hour, calculated based on a road miles from either the Carson City Courthouse or the Washoe County Courthouse:

Zone 1	0 to 75 miles	\$0.00
Zone 2	75 to 150 miles	\$5.00
Zone 3	150 to 300 miles	\$6.00
Zone 4	300 miles and over	\$7.00

No remote area pay shall be paid within ten (10) miles of employee’s permanent place of residence in the State of Nevada.

ADD PREMIUM PAY

One and one half (1 ½) the regular straight time hourly rate shall be paid:

1. For all hours worked over eight (8) hours in one day or shift.
2. For any hours worked on Saturday from midnight to midnight.

Double the regular straight time hourly rate shall be paid for all time:

1. For all hours worked over twelve (12) hours in one day or shift.
2. For any hours worked on Sunday from midnight to midnight.
3. For any hours worked on holidays from midnight to midnight.

RECOGNIZED HOLIDAYS

If any of these holidays fall on Sunday, the Monday following shall be considered a Holiday.

New Year’s Day, President’s Day, Memorial Day, Independence Day, Labor Day, Veteran’s Day, Thanksgiving Day, Day after Thanksgiving Day, Christmas Day.

JOB DESCRIPTION: Excerpt from Agreement between AGC and LIUNA Local 169

1. Distributing traffic control signs and markers along site in designated pattern;
2. Informing drivers of detour routes through construction sites;

Craft: Truck Driver (Non-Union Rate)

Prevailing wage rates include the base rate as well as all applicable fringes

Dump Trucks (Single or Multiple Units Including Semi's & Double Transfer Units), Dumpcretes and Bulk Cement Spreader

Under 4 yds. (water level).....	32.25
4 yds. & under 8 yds. (water level).....	32.25
8 yds. & under 18 yds. (water level).....	32.25
18 yds. & under 25 yds. (water level)	32.25
25 yds. & under 60 yds. (water level).....	32.25
60 yds. & under 75 yds. (water level)).....	32.25
75 yds. & under 100 yds. (water level)).....	32.25
100 yds. & under 150 yds. (water level)).....	32.25
150 yds. & under 250 yds. (water level)).....	32.25
250 yds. & under 350 yds. (water level)).....	32.25
350 yds. & over (water level).....	32.25

Transit Mix

Under 8 yds.....	32.25
Under 8 yds & including 12 yds.....	32.25
Over 12 yds.....	32.25

Transit Mix (Using Boom)

Transit mix with boom shall receive 16 cents per hour above the appropriate yardage classification rate of pay when such boom is used.....	32.25
--	-------

Water & Jetting Trucks

Up to 2,500 gallons.....	32.25
Up to 2,500 gallons & over.....	32.25
DW 20's & 21's & other similar Cat type, Terry Cobra LeTourneau pulls, Tournerocker, Euclid, & similar type equipment when pulling Aqua/Pak, Water Tank Trailers, & Fuel, and/or Grease Tank Trailer, or other miscellaneous Trailers, (except as defined under "Dump Trucks")	
Heavy Duty Transport (High Bed).....	32.25
Heavy Duty Transport(Gooseneck low bed).....	32.25
Tiltbed or Flatbed Pull Trailers..	32.25
Bootman, Comb. Bootman & Road Oiler.....	32.25
Flat Rack (2 or 3 axle unit).....	32.25

Bus & Manhaul Drivers

Up to 18,000 lbs. (single unit).....	32.25
18,000 lbs. and over	32.25
Warehousemen Spotter	32.25

Winch Truck & "A" Frame Drivers

Up to 18,000 lbs.	32.25
18,000 lbs. and over.....	32.25
Warehousemen Spotter.....	32.25
Warehouse Clerk.....	32.25
Tire Repairmen.....	32.25
Truck Repairmen.....	32.25
Pick Up Truck & Pilot Cars (Jobsite)	32.25
Pick Up Truck & Pilot Cars (Over the road)	32.25
Truck Oil Greaser.....	32.25
Fuel Truck Driver.....	32.25
Fuel Man & Fuel Island Man.....	32.25
Oil Tanker.....	32.25

Oil Tanker with Pup.....	32.25
Foreman.....	32.25

TRUCK DRIVER

Includes but is not limited to:

Driving a tractor trailer combination or a truck to transport goods or materials at the site of a public work or between sites of a public work. (Also, see descriptions listed with Truck Driver rates, if any.)

Craft: WELL DRILLER (Non-Union Rate)

Prevailing wage rates include the base rate as well as all applicable fringes

Well Driller.....60.78

JOB DESCRIPTION

1. Setting, operating or tending to portable drilling rig machinery and related equipment to drill wells;
2. Extending stabilizing jackscrews to support and level a drilling rig;
3. Installing water well pumps;
4. Drillings wells for industrial water supplies, irrigation water supplies or water supplies for any other purpose; dewatering or other similar purposes; exploration; hole drilling for geologic and hydrologic information; and core drilling for geologic information.

GROUP CLASSIFICATIONS

LABORER, includes but is not limited to:

Group 1

- All cleanup work of debris, grounds, and building including windows and tile
- Dumpmen or Spotter (other than asphalt)
- Handling and Servicing of Flares, Watchmen
- General Laborer
- Guideposts and Highway Signs
- Guardrail Erection and Dismantling
- Limber, Brushloader and Piler
- Pavement Marking and Highway Striping
- Traffic Barrier Erector
- Tending to portable space heaters
- Profilograph work all types manual, self propelled or carts
- Gabion basket, building, handling, installation and rigging
- Dry set paver work
- Traffic Barrier Erector

Group 2

- Choker setter or Rigger (clearing work only) Pittsburgh
- Chipper and similar type brush shredders
- Concrete worker (wet or dry) all concrete work not listed in Group 3 included but not limited to: concrete forms stripping, handling, cleaning, oiling and moving to the next point of installation.
- Crusher or Grizzly Tender
- Greasing Dowels
- Guinea Chaser (Stakemen)
- Panel Forms (wood or metal) handling, cleaning and stripping of Loading and unloading, (Carrying and handling of all rods and material for use in reinforcing concrete
- Railroad Trackmen (maintenance, repair or builders)
- Sloper
- Semi-Skilled Wrecker (salvaging of building materials other than those listed in Group 3)
- Waterproofing work
- Epoxy rebar/dowels and anchoring dowel baskets
- Placement pouring of concrete including any epoxy resin or similar materials, rodding, spreading and tamping concrete, brooming or brushing, hand application of curing compounds, applying topping (wet or dry) colors or grits, and exposed finishes for architectural work
- Concrete patching, dry packing, chipping, stoning, and grouting
- Concrete cold weather/rain protection and curing
- Placement /anchoring of all earth stabilization/filters fabrics,
- Mechanically stabilized Earth (MSE) and Keystone type retaining walls rigging, placing , aligning, backfilling and installation of dead men and any stabilization components

Group 3

- Asphalt Workers (Ironers, Shovelers, Cutting Machine)
- Buggymobile
- Chainsaw, Faller, Logloader and Bucker

- Compactor (all types)
- Concrete Mixer under 1/2 yard
- Concrete Pan Work (Breadpan type), handling, cleaning\stripping
- Concrete Saw, Chipping, Grinding, Sanding, Vibrator
- Cribbing, Shoring, Lagging, Trench Jacking, Hand-Guided Lagging Hammer
- Curbing or Divider machine
- Curb Setter (precast or cut)
- Ditching Machine (hand-guided)
- Drillers Helper, Chuck Tender
- Fence erector including safety, chain link, turtle, field and barbe wire fencing
- Form Raiser, Slip Forms
- Grouting of Concrete Walls, Windows and Door Jams
- Headerboardmen
- Jackhammer, Pavement Breaker, Air Spade
- Mastic Worker (wet or dry)
- Pipewrapper, Kettlemen, Potmen, and men applying asphalt, creosote and similar type materials
- All Power Tools (air, gas, or electric), Post Driver
- Riprap-Stonepaver and RockSlinger, including placing of sack concrete wet or dry
Rototiller
- Rigging and Signaling in connection with Laborers' work
- Sandblaster, Potmen, Gunmen or Nozzlemen water blasting not covered in group 5A
- Vibra-screed
- All demolition and wrecking work including but not limited t any torch work cutting, burning, plasma are, dust control, and salvaging (removing and salvaging of all materials, windows, doors, plumbing, and electrical fixtures) and use of customary tools and equipment for demolition and wrecking
- All underpinning foundation work, digging and underpinning pits, removal of debris with tuggers or other methods, cutting, handling and installing all shoring boards and lagging boards used for underpinning and foundation work, placement and tying of steel reinforcing for underpinning piers, all tiebacks and soil nail work drilling and grouting, all soldier beam work and us of customary tools and equipment for underpinning foundation work

Group 3A

- Concrete Specialist
- Setting screeds
- Screed pins
- Curb forms and curb and gutter forms,
- Using Darby and push floats,
- Hand trowels or hand floating
- Marking edging
- Using base cove or step tools
- Spreading and finishing gypsum
- Concrete grinding machines (the terms does not include Rotomill machines for highway overlay grinding)
- Troweling machines,
- Floating machines
- Finishing of epoxy or resin materials,
- Operation of skill saw
- Laser Screed
- Laser Level

- Curb and Slipform machines,
- Stamps or other means or texturing,
- Any new devices which are beneficial to the construction of or with concrete or related products.

Group 4

- Burning and Welding in connection with Laborers' work
- Joy Drill Model TWM-2A, Gardner Denver Model DN143 and similar type drills (in accordance with Memorandum of Understanding between Laborers and Operating Engineers dated at Miami, Florida, Feb. 3, 1954) and Track Drillers, Diamond Core Drillers, Wagon Drillers, Mechanical Drillers on Multiple Units
- High scalers including but not limited to laying, anchoring, pinning, cabling and stretching of any rock fall netting, mesh or wire fabric and use of customary tools and equipment for high scaling
- Concrete pump operator
- Heavy Duty Vibrator with Stinger 5" diameter or over
- Pipelayer, Caulker and Bander
- Pipelayer-waterline, Sewerline, Gasoline, Conduit and all other types of composition for any purpose buried under ground outside of building including, stringing, trench shoring, backfilling sanding, caution taping, all walk behind equipment and spotting
- Laborer work in connection with micro tunneling, directional drilling and pipe-jacking
- Cathodic protection, grounding for pipe work
- Cleaning of Utility Lines
- Slip Lining of Utility Lines (including operation of Equipment)
- TV Monitoring and Grouting of Utility Lines
- Asphalt Rakers and Asphalt dump Man
- All mechanical and pressurized pipe work, including the installation of pipe above and below ground, cathodic protection, bolt up, and support installation in connection to water conveyance, c

Group 4A

- Foreman

Group 5

- Construction Specialists
- Blasters and Powdermen, all work of loading, placing, and blasting of all powder and explosives of any type, regardless of method used for such loading and placing
- Asbestos removal
- Lead abatement
- Hazardous waste
- Material removal

Group 5A

- Pavement Marking and Highway Striping
- Pavement Marking and Highway Striping Foreman
- Pavement Marking and Highway Striping work includes but is not limited to: All work by any method performed in connection with the permanent or temporary application and installation of pavement marking of any kind, brand, type or style on parking lots, airfields, highways, streets and other such surfaces and all work performed in connection with removal of pavement.

Group 6

- Gunit Foremen, Nozzlemen, Rodmen, Gunmen, Materialmen, Reboundmen

- Tunnel and shaft workers/miners and use of customary tools and equipment for tunnel and mine work All worked performed in a compressed air tunnel shaft or chamber including the use of hand, power tools or equipment as necessary in connection with compressed air work
-

OPERATING ENGINEER, includes but is not limited to:

Group 1

- Engineer Assistant

Group 1A

- Oiler (Construction)
- Partsman

Group 2

- Compressor Operator
- Material Loader and/or Conveyor Operator (handling building materials)
- Pump Operator

Group 3

- Bobcat or similar loader, 1/4 cu. yd. or less
- Concrete Curing Machines (streets, highways, airports, canals)
- Conveyor Belt Operator (tunnel)
- Forklift (under 20)
- Engineer Generating Plant (500 K.W.)
- Mixer Box Operator (concrete plant)
- Motorman
- Rodman/Chainman
- Rotomist Operator
- Oiler (truck crane)

Group 4

- Concrete Mixer Operator, Skip type
- Dinky Operator
- Forklift (20' or over) or Lumber Stacker
- Ross Carrier
- Skip Loader Operator (under one (1) cu. yd.)
- Tie Spacer

Group 5

- Concrete Mixers (over one (1) cu. yd.)
- Concrete Pumps or Pumpcrete Guns
- Elevator and Material Hoist (one (1) drum)
- Groundman for Asphalt Milling and similar

Group 6

- Auger type drilling equipment up to and including 30 ft. depth digging capacity M.R.C.
- Boom Truck or Dual-Purpose a-Frame Truck
- B.L.H. Lima Road Pactor or similar
- Chip Box Spreader (Flaherty type or similar)
- Concrete Batch Plant (wet or dry)
- Concrete Saws (highways, streets, airports, canals)
- Locomotives (over thirty (30) tons)
- Maginnis International Full Slab Vibrator (airports, highways, canals and warehouses)
- Mechanical Finishers (concrete) (Clary, Johnson, Bidwell Bridge Deck or similar types)

- Mechanical Burn, Curb and/or Curb and Gutter Machine (concrete or asphalt)
- Pavement Breaker, Truck Mounted, with compressor combination
- Pavement Breaker or Tamper (with or without compressor combination)
- Power Jumbo Operator (setting slip-forms, etc., in tunnels)
- Roller Operator (except asphalt)
- Self-Propelled Tape Machine
- Self-Propelled Compactor (single engine)
- Self-Propelled Power Sweeper Operator
- Slip-Form Pump (power-driven by hydraulic, electric, air, gas, etc. lifting device for concrete forms)
- Small Rubber-Tired Tractors
- Snooper Crane, Paxton-Mitchell or similar
- Stationary Pipe Wrapping, Cleaning and Bending Machine Operator

Group 7

- Auger type drilling equipment over 30 ft. depth digging capacity M.R.C.
- Compressor (over 2)
- Concrete Conveyor or Concrete Pump, truck or equipment mounted (any assistance required shall be performed by an Assistant to Engineer) Boom length to apply Concrete Conveyor, Building Site
- Drilling and Boring Machine, vertical and horizontal (not to apply to waterliners, wagon drills or jack hammers)
- Crusher Plant Engineer
- Generators
- Instrument Man
- Kolman Loader
- Material Hoist (two (2) or more drums)
- Mine or Shaft Hoist
- Pipe Bending Machines (pipeline only)
- Pipe Cleaning Machines (tractor-propelled and supported)
- Pipe Wrapping Machines (tractor-propelled and supported)
- Portable Crushing and Screening Plants
- Post Driller And/or Driver
- Pumps (over 2)
- Screedman (except asphaltic or concrete paving)
- Self-Propelled Boom-Type Lifting Device (center mount) (on ten (10) ton capacity or less)
- Slusher Operator
- Soil Tester (Certified)
- Soils and Materials Tester
- Surface Heater and Planer Operator
- Trenching Machine (maximum digging capacity three (3) ft. depth) (Any assistance in the operation, if needed, shall be performed by an Assistant to Engineer)
- Truck-Type Loader
- Welding Machines (gasoline or diesel)

Group 8

- Articulated on-Site Dump Trucks
- Asphalt Plant Engineer
- Asphalt Milling Machine

- Cast-In-Place Pipe-Laying Machine
- Combination Slusher and Motor Operator
- Concrete Batch Plant (multiple units)
- Dozer Operator
- Drill Doctor
- Elevating Grader Operator
- Stiff Frame Off Road Haul Trucks
- Grooving and Grinding Machine (highways)
- Ken Seal Operator
- Marination Plant
- Loader (up to and including two and one-half (2 1/2) cu. yds)
- Mechanical Finishers or Spreader Machine (asphalt, Barber-Greene or similar)
- Shuttle Buggy
- Mechanical Trench Shield
- Mixermobile
- Push Cats
- Road Oil Mixing Machine Operator Wood-Mixer (and other similar Pugmill equipment)
- Roller Operator (asphalt)
- Rubber-Tired Earthmoving Equipment (up to and including thirty-five (35) cu. yds. "struck " M.R.C., Euclids, T-Pulls, DW10, 20, 21 and similar)
- Water Pull
- Screedman (Barber-Greene and similar) (asphaltic or concrete paving)
- Self-Propelled Compactors with Dozer; Hyster 450, Cat 825 or similar
- Sheepfoot
- Small Tractor (with boom)
- Soil Stabilizer (P & H or equal)
- Timber Skidder (rubber-tired) or similar equipment
- Track Loader
- Tractor-Drawn Scraper
- Tractor Operator
- Tractor-Mounted Compressor Drill Combination
- Trenching Machine Operator (over three (3) feet depth)
- Tri-Batch Paver
- Tunnel Badger or Tunnel Boring Machine Operator
- Tunnel Mole Boring Machine
- Vermeer T-600b Rock Cutter
- Vacuum Truck(excludes trailer mounted vaccums)

Group 9

- Chicago Boom
- Combination Backhoe and Loader (up to and including 3/8 cu. yd.)
- Combination Mixer and Compressor (gunite)
- Heavy Duty Repairman and/or Welder
- Lull Hi-Lift (twenty (20) feet or over)
- Mucking Machine
- Sub-Grader (Gurries or other types)
- Tractor (with Boom) (D6 or larger)
- Track-Laying-Type Earthmoving Machine (single engine with tandem scrapers)

Group 10

- Boom-Type Backfilling Machine
- Bridge Crane
- Cary-Lift or similar
- Chemical Grouting Machine
- Chief of Party
- Derricks (two (2) Group 10 Operators required when swing engine remote from hoist)
- Derrick Barges (except excavation work)
- Euclid Loader and similar types
- Heavy Duty Repairman
- Heavy Duty Rotary Drill Rigs
- Lift-Slab (Vagtborg and similar types)
- Loader (over two and one-half (2 1/2 cu. yds. up to and including four (4) cu. yds.)
- Locomotive (over one hundred (100) tons, single or multiple units)
- Multiple-Engine Earthmoving Machines (Euclid Dozers, etc.)
- Pre-Stress Wire Wrapping Machine
- Rubber-Tired Scraper, Self-Loading
- Single-Engine Scraper (over thirty-five (35) cu. yds.)
- Shuttle Car (Reclaim Station)
- Train Loading Station
- Trenching Machine multi-engine with sloping attachments (Jefco or similar)
- Vacuum Cooling Plant
- Whirley Crane (up to and including twenty-five (25) tons)

Group 10A

- Backhoe-Hydraulic (up to and including one (1) cu. yd.)
- Backhoe (up to and including one (1) cu. yd.) (Cable)
- CMI Dual Lane Auto-Grader SP30 or similar type
- Cranes (not over twenty-five (25) tons) (hammerhead and gantry)
- Finish Blade
- Gradalls (up to and including one (1) cu. yd.)
- Motor Patrol Operator
- Power Shovels, Clamshells, Draglines, Cranes (up to and including one (1) cu. yd.)
- Rubber-Tired Scraper, Self-Loading (twin engine)
- Self-Propelled Boom-Type Lifting Device, center mount (over 10 tons up to and including 25 tons)

Group 11

- Automatic Asphalt or Concrete Slip-Form Paver
- Automatic Railroad Car Dumper
- Canal Trimmer
- Cary Lift, Campbell or similar type
- Cranes (over twenty-five (25) tons)
- Euclid Loader when controlled from the Pullcat
- Finish Blade
- Gradesetter, Grade Checker
- Highline Cableway Operator
- Loader (over four (4) cu. yds. up to and including twelve (12) cu. yds.)
- Multi-Engine Earthmoving Equipment (up to and including seventy-five (75) cu. yds. struck m.r.c.)
- Multi-Engine Scrapers (when used to Push Pull)

- Power Shovels, Clamshells, Draglines, Backhoes Gradalls (over one (1) cu. yd. and up to and including seven (7) cu. yds. m.r.c.)
- Self-Propelled Boom-Type Lifting Device (center mount) (over 25 tons m.r.c.)
- Self-Propelled Compactor (with multiple-propulsion power units)
- Single-Engine Rubber-Tired Earthmoving Machine, with Tandem Scraper
- Slip-Form Paver (concrete or asphalt)
- Tandem Cats and Scraper
- Tower Crane Mobile (including Rail Mount)
- Truck Mounted Hydraulic Crane when remote control equipped (over 10 tons up to and including 25 tons)
- Universal Liebherr and Tower Cranes (and similar types)
- Wheel Excavator (up to and including seven hundred fifty (750) cu. yds. per hour)
- Whirley Cranes (over twenty-five (25) tons)

Group 11A

- Band Wagons (in conjunction with Wheel Excavators)
- Operator of Helicopter (when used in construction work)
- Loader (over twelve (12) cu. yds.)
- Multi-Engine Earthmoving Equipment (over seventy-five (75) cu. yds. "struck" m.r.c.)
- Power Shovels, Clamshells, Draglines, Backhoes, and Gradalls (over seven (7) cu. yds. m.r.c.)
- Remote-Controlled Earth Moving Equipment
- Wheel Excavator (over seven hundred fifty (750) cu. yds. per hour)

Group 11B

- Holland Loader or similar or Loader (over 18 cu. yds.)
-

OPERATING ENGINEERS - Steel Fabricator & Erector

Group 1

- Cranes over 100 tons
- Derrick over 100 tons
- Self-Propelled Boom Type Lifting Devices over 100 tons

Group 2

- Cranes over 45 tons up to and including 100 tons
- Derrick, 100 tons and under
- Self-Propelled Boom Type Lifting Device, over 45 tons
- Tower Crane

Group 3

- Cranes, 45 tons and under
- Self-Propelled Boom Type Lifting Device, 45 tons and under

Group 4

- Chicago Boom
- Forklift, 10 tons and over
- 59
- Heavy Duty Repairman/Welder

Group 5

- Boom Cat
-

OPERATING ENGINEER -PILEDRIVER

Group 1

- Derrick Barge Pedestal mounted over 100 tons
- Clamshells over 7 cu. yds.
- Self-Propelled Boom Type Lifting Device, over 100 tons
- Truck Crane or Crawler, land or barge mounted over 100 tons

Group 2

- Derrick Barge Pedestal mounted 45 tons up to and including 100 tons
- Clamshells up to and including 7 cu. yds.
- Self-Propelled Boom Type Lifting Device over 45 tons
- Truck Crane or Crawler, land or barge mounted, over 45 tons up to and including 100 tons

Group 3

- Derrick Barge Pedestal mounted under 45 tons
- Self-Propelled Boom Type Lifting Device 45 tons and under
- Skid/Scow Piledriver, any tonnage
- Truck Crane or Crawler, land or barge mounted 45 tons and under

Group 4

- Assistant Operator in lieu of Assistant to Engineer
- Forklift, 10 tons and over
- Heavy Duty Repairman/Welder

Group 5

No current classification

Group 6

- Deck Engineer

Group 7

No current classification

Group 8

- Deckhand
 - Fireman
-



DEPARTMENT OF BUSINESS AND INDUSTRY
OFFICE OF THE LABOR COMMISSIONER

2024-2025 Prevailing Wage

Amendment 1

- **AMENDMENT 1**
- **Classification – Ironworker**
- **County – All Regions**
- **Effective – January 1, 2025**

The following represents the amended wage rates

Prevailing wage rates include the base rate as well as all applicable fringes

Ironworker-Journeyman.....	86.36
Ironworker -Foreman.....	91.46

SECTION 01200 - PROJECT MEETINGS

PART 1- GENERAL

1.1 RELATED DOCUMENTS

- A. Drawings and general provisions of the Contract, including all bid documents and addendums associated with this project shall apply to this section.

1.2 SUMMARY

- A. This section includes administrative and procedural requirements for project meetings including, but not limited, to the following:
 - 1. Pre-Construction Conference
 - 2. Pre-Installation Conferences
 - 3. Coordination Meetings
 - 4. Progress Meetings
 - 5. Start-up / Training
 - 6. Service, maintenance, warranty review.
- B. Construction Schedules are specified in Division 1 SECTION 01310-A – PROGRESS SCHEDULES.

1.3 PRE-CONSTRUCTION CONFERENCE

- A. The Contractor shall schedule a pre-construction conference and organizational meeting at the project site or other convenient location no later than fifteen (15) days after execution of the Contract and prior to commencement of any construction activities. The Contractor shall conduct the meeting to review scope, responsibilities, personnel assignments, Permits, submittals, safety, emergency action plans, contacts, schedule, etc.
- B. Attendees: Owner; Architect, and their consultants; Contractor and their Superintendent and major sub-contractors; and manufacturers, suppliers and other concerned appropriate parties shall each be represented at the conference by persons familiar with and authorized to conclude matters relating to the work.
- C. Agenda: Discuss items of significance that could affect progress including such topics as:
 - 1. Construction schedule

SECTION 01200 - PROJECT MEETINGS

2. Critical work sequencing
3. Designation of responsible personnel
4. Procedures for processing field decisions and change orders
5. Procedures for processing Applications for Payment
6. Submittal of Shop Drawings, product data and samples
7. Preparation of Record Documents
8. Use of the premises
9. Office, work and storage areas
10. Equipment deliveries and priorities
11. Safety and Security, emergency procedures
12. Housekeeping
13. Working hours

1.4 PRE-INSTALLATION CONFERENCES

- A. Conduct a pre-installation conference at the site before each major construction activity that requires coordination with other construction. The installer and representatives of manufacturers and fabricators involved in or affected by the installation, and its coordination of integration with other materials and installations that have preceded or will follow, shall attend the meeting. The Contractor shall advise the Architect of scheduled meeting dates.
- B. Review the progress of other construction activities and preparations for the particular activity under consideration at each pre-installation conference, including requirements for:
 1. Contract Documents
 2. Options
 3. Related Change Orders
 4. Purchases
 5. Deliveries

SECTION 01200 - PROJECT MEETINGS

6. Shop Drawings, products data and quality control samples
 7. Possible conflicts
 8. Compatibility problems
 9. Time schedules
 10. Weather limitations
 11. Manufacturer's recommendations
 12. Compatibility of materials
 13. Acceptability of substrates
 14. Temporary facilities
 15. Space and access limitations
 16. Governing regulations
 17. Inspection and testing requirements
 18. Required performance results
 19. Recording requirements
 20. Protections
- C. Record significant discussions and agreements and disagreements of each conference, along with the approved schedule. Distribute the minutes of the meeting to everyone concerned, promptly, including the Owner and the Architect.
- D. Do not proceed if the conference cannot be successfully concluded. Initiate whatever actions are necessary to resolve impediments to performance of work and reconvene the conference at the earliest feasible date.

1.5 PROGRESS MEETINGS

- A. Conduct a weekly progress meeting at the project site at regularly scheduled intervals. Coordinate with the Owner and the Architect of scheduled meeting dates. Coordinate dates of meetings with preparation of the payment request, Change Order request, mockup reviews, etc.

SECTION 01200 - PROJECT MEETINGS

- B. Attendees: In addition to representatives of the Owner, Architect, Construction Manager each sub-contractor, supplier or other entity concerned with current progress or involved in planning, coordination or performance of future work shall be represented at these meetings by persons familiar with the project and authorized to conclude matters relating to progress.
- C. Agenda: Review and correct or approve minutes of the previous progress meeting. Review other items of significance that could affect progress. Include topics for discussion as appropriate to the current status of the project.
 - 1. Contractor's Construction Schedule: Review progress since the last meeting. Determine where each activity is in relation to the Contractor's construction schedule, whether on time or ahead or behind schedule. Determine how construction that is behind schedule will be expedited; and secure commitments from parties involved to do so. Discuss whether schedule revisions are required to ensure that current and subsequent activities will be completed within the allotted contract time.
 - 2. Review the present and future needs of each entity present, including such items as:
 - a. Interface requirements
 - b. Time
 - c. Sequence
 - d. Deliveries
 - e. Off-site fabrication problems
 - f. Access
 - g. Site utilization
 - h. Temporary facilities
 - i. Hours of work
 - j. Hazards of work
 - k. Housekeeping
 - l. Quality and work standards
 - m. Change Orders
 - n. Documentation of information for payment requests
- D. Reporting: No later than three (3) days after each progress meeting date, distribute copies of minutes of the meeting to each party present and to other parties who should have been present. Include a brief summary, in narrative form, of progress since the previous meeting and report.
 - 1. Schedule Updating: update the construction progress schedule after each progress meeting where modifications to the schedule have been made or recognized. Issue the updated schedule concurrently with the report of each meeting.

SECTION 01200 - PROJECT MEETINGS

1.6 GUARANTEE/WARRANTIES; BONDS; AND SERVICE AND MAINTENANCE CONTRACTS REVIEW MEETING:

- A. Eleven (11) months following the date of Substantial Completion of the work, hold a meeting for the purpose of review of guarantees/warranties; bonds; and service and maintenance contracts for materials and equipment.
- B. Meeting location shall be at a mutually agreed upon site, as convenient as possible for all parties.
- C. Attending shall be representatives of the following:
 - 1. Owner
 - 2. Architect
 - 3. Owner's and Architect's Consultants, as appropriate to the agenda
 - 4. Construction Manager
 - 5. Commissioning Agent
 - 6. Contractor
 - 7. Sub-contractors, as appropriate to the agenda
 - 8. Suppliers, as appropriate to the agenda
 - 9. Others, as appropriate to the agenda
- D. Owner will prepare an agenda for the meeting and distribute it to the attendees a minimum of seven (7) calendar days in advance of the scheduled meeting date.
- E. The Contractor shall take action as appropriate to implement repair or replacement of defective items and to extend service and maintenance contracts.
- F. Owner or Owners Representative shall take meeting notes and distribute them to all attendees. Attendees taking exception to anything in the meeting notes shall state in writing to the Owner within five (5) working days, following receipt of meeting notes.

PART 2 – PRODUCTS (Not Applicable)

PART 3 – EXECUTION (Not Applicable)

END OF SECTION 01200

SECTION 01300 – SUBMITTALS

PART 1 - GENERAL

1.1 RELATED DOCUMENTS

- A. Drawings and general provisions of the Contract, including all bid documents and addendums associated with this project shall apply to this section.

1.2 SUMMARY

- A. This section includes administrative and procedural requirements for submittals required for performance of the work, including the following:
 - 1. Submittal Schedule
 - 2. Daily Construction Reports
 - 3. Shop Drawings
 - 4. Product Data
 - 5. Samples
 - 6. Quality Assurance Submittals
 - 7. Record Drawings
 - 8. Record Specifications
- B. Administrative Submittals: Refer to other Division 1 Sections and other contract documents for requirements for administrative submittals. Such submittals include, but are not limited to, the following:
 - 1. Permits
 - 2. Applications for Payment
 - 3. Performance and Labor & Material Bonds
 - 4. Insurance Certificates
 - 5. List of Sub-Contractors
- C. Related Sections: The following sections contain requirements that relate to this section:

SECTION 01300 – SUBMITTALS

1. Division 1 SECTION 01027 – APPLICATION FOR PAYMENT specifies requirements for submittal of the Schedule of Values.
2. Division 1 SECTION 01040 - COORDINATION specifies requirements governing preparation and submittal of required coordination drawings.
3. Division 1 SECTION 01200 – PROJECT MEETING specifies requirements for submittal and distribution of meeting and conference minutes.
4. Division 1 SECTION 01400 – QUALITY CONTROL specifies requirements for submittal of inspection and test reports.
5. Division 1 SECTION 01700 – CONTRACT CLOSEOUT specifies requirements for submittal of project Record Documents and warranties at project closeout.

1.3 DEFINITIONS

- A. Coordination drawings show the relationship and integration of different construction elements that require careful coordination during fabrication or installation to fit in the space provided or to function as intended.
 1. Preparation of coordination drawings is specified in Division 1 SECTION 01040 - COORDINATION and may include components previously shown in detail on Shop Drawings or Product Data.
- B. Field samples are full size physical examples erected onsite to illustrate finishes, coatings or finish materials. Field samples are used to establish the standard by which the work will be judged.
- C. Mockups are full size assemblies for review of construction, coordination, testing or operation; they are not samples.

1.4 SUBMITTAL PROCEDURES

- A. Coordination: Coordinate preparation and processing of submittals with performance of construction activities. Transmit each submittal sufficiently in advance of performance of related construction activities to avoid delay.
 1. Coordinate each submittal with fabrication, purchasing, testing, delivery, other submittals and related activities that require sequential activity.
 2. Coordinate transmittal of different types of submittals for related elements of the work so processing will not be delayed by the need to review submittals concurrently for coordination.

SECTION 01300 – SUBMITTALS

- a. The Architect reserves the right to withhold action on a submittal requiring coordination with other submittals until all related submittals are received.
3. Processing: To avoid the need to delay installation as a result of the time required to process submittals, allow sufficient time for submittal review, including time for resubmittals.
 - a. Allow three (3) weeks for initial review. Allow additional time if the Architect must delay processing to permit coordination with subsequent submittals, or needs additional information to complete review.
 - b. If an intermediate submittal is necessary, process the same as the initial submittal.
 - c. Allow two (2) weeks for reprocessing each submittal.
 - d. No extension of contract time, overhead or profit will be authorized because of failure to transmit submittals to the Architect sufficiently in advance of the work to permit processing.
 - e. Allow four (4) weeks for initial review of any submittal requiring review by Authority Having Jurisdiction (AHJ). A listing of these known submittals is indicated on the contract drawings, but this is not necessarily exhaustive.
- B. Submittal Preparation: Place a permanent label or title block on each submittal for identification. Indicate the name of the entity that prepared each submittal on the label or title block.
 1. Provide a space approximately 4" x 5" (100 x 125 mm) on the label or beside the title block on the Shop Drawings to record the Contractor's review and approval markings and the action taken.
 2. Include the following information on the label for processing and recording action taken:
 - a. Project Name
 - b. Date
 - c. Name and Address of the Architect
 - d. Name and Address of the Contractor
 - e. Name and Address of Sub-Contractor
 - f. Name and Address of Supplier
 - g. Name of the Manufacturer
 - h. Number and Title of appropriate specification section
 - i. Drawing Number and detail references, as appropriate
- C. Submittal Transmittal: Package each submittal appropriately for transmittal and handling. Transmit each submittal from the Contractor to the Architect using a transmittal form. The Architect will not accept submittals received from sources other than the Contractor.

SECTION 01300 – SUBMITTALS

1. On the transmittal, record relevant information and requests for data. On the form, or separate sheet, record deviations from contract document requirements, including variations and limitations. Include Contractor's certification that information complies with contract document requirements.
2. Transmittal Form: Use AIA Document G810.

1.5 SUBMITTAL SCHEDULE

- A. After development and acceptance of the Contractor's construction schedule, prepare a complete schedule of submittals. Submit the schedule within ten (10) days of the date required for submittal of the Contractor's construction schedule.
 1. Coordinate submittal schedule with the list of sub-contracts, schedule of values and the list of products as well as the Contractor's construction schedule.
 2. Prepare the schedule in chronological order. Provide the following information:
 - a. Scheduled date for the first submittal
 - b. Related section number
 - c. Submittal category (Shop Drawings, Product Data or Samples)
 - d. Name of the Sub-Contractor
 - e. Description of the part of the work covered
 - f. Scheduled date for resubmittal
 - g. Scheduled date for the Architect's final release or approval
- B. Distribution: Following response to the initial submittal, print and distribute copies to the Architect, Owner, Sub-Contractors and other appropriate parties required to comply with submittal dates indicated. Post copies in the project meeting room and field office.
 1. When revisions are made, distribute to the same parties and post in the same locations. Delete parties from distribution when they have completed their assigned portion of the work and are no longer involved in construction activities.
- C. Schedule Updating: Revise the schedule after each meeting or activity where revisions have been recognized or made. Issue the updated schedule concurrently with the report of each meeting.

1.6 DAILY CONSTRUCTION REPORTS

- A. Prepare a daily construction report recording the following information concerning events at the site and submit duplicate copies to the Architect and Owner daily:

SECTION 01300 – SUBMITTALS

1. List of sub-contractors at the site
2. Exact count of personnel at the site from each contractor or sub-contractor
3. Time spent by each person working on site vs off the job site
4. High and low temperatures, general weather conditions
5. Accidents and unusual events
6. Meetings and significant decisions
7. Stoppages, delays, shortages and losses
8. Emergency procedures
9. Orders and requests of governing authorities
10. Change Orders received, implemented
11. Services connected, disconnected
12. Equipment or system tests and startups
13. Partial Completions, occupancies
14. Substantial Completions authorized
15. Record Drawing identified changes
16. Record Specification identified changes

1.7 SHOP DRAWINGS

- A. Submit newly prepared information drawn accurately to scale. Highlight, encircle or otherwise indicate deviations from the contract documents. Do not reproduce contract documents or copy standard information as the basis of Shop Drawings. Standard information prepared without specific reference to the project is not a Shop Drawing.
- B. Shop Drawings include fabrication and installation drawings, setting diagrams, schedules, patterns, templates and similar drawings. Include the following information:
 1. Dimensions

SECTION 01300 – SUBMITTALS

2. Identification of products and materials included by sheet and detail number
3. Compliance with specified standards
4. Notation of coordination requirements
5. Notation of dimensions established by field measurement
6. Sheet Size: Except for templates, patterns and similar full size drawings, submit Shop Drawings on sheets at least 8½" x 11" but, no larger than 30" x 42".
7. Submit in the quantity the Contractor requires to be returned, together with four (4) additional copies each of brochures, catalog cuts and similar material for mechanical, electrical, hardware and elevator items; and three (3) additional copies for all others.
8. Do not use Shop Drawings without an appropriate final stamp indicating action taken.

1.8 PRODUCT DATA

- A. Collect Product Data into a single submittal for each element of construction or system. Product Data includes printed information, such as manufacturer's installation instructions, catalog cuts, standard color charts, roughing in diagrams and templates, standard wiring diagrams and performance curves.
 1. Mark each copy to show applicable choices and options. Where printed, Product Data includes information on several products that are not required, mark copies to indicate the applicable information. Include the following information:
 - a. Manufacturer's printed recommendations
 - b. Compliance with trade association standards
 - c. Compliance with recognized testing agency standards
 - d. Application of testing agency labels and seals
 - e. Notation of dimensions verified by field measurement
 - f. Notation of coordination requirements
 2. Do not submit Product Data until compliance with requirements of the contract documents has been confirmed.
 3. Preliminary Submittal: Submit a preliminary single copy of Product Data where selection of options is required.

SECTION 01300 – SUBMITTALS

4. Submittals: Submit three (3) copies of each required submittal; submit four (4) copies where required for maintenance manuals. The Architect will retain one and will return one (1) marked with action taken and corrections or modifications required. One (1) copy with review comments will be supplied to the Owner.
 - a. Unless non-compliance with contract document provisions is observed, the submittal may serve as the final submittal.
5. Distribution: Furnish copies of final submittal to installers, sub-contractors, suppliers, manufacturers, fabricators and others required for performance of construction activities. Show distribution on transmittal forms.
 - a. Do not proceed with installation until a copy of Product Data is in the installer's possession.
 - b. Do not permit use of unmarked copies of Product Data in connection with construction.

1.9 SAMPLES

- A. Submit full size, fully fabricated samples cured and finished as specified and physically identical with the material or product proposed. Samples include partial sections of manufactured or fabricated components, cuts or containers of materials, color range sets and swatches showing color, texture and pattern.
 1. Mount or display samples in the manner to facilitate review of qualities indicated. Prepare samples to match the Architect's sample. Include the following:
 - a. Specification section number and reference
 - b. Generic description of the sample
 - c. Sample source
 - d. Product name or name of the manufacturer
 - e. Compliance with recognized standards
 - f. Availability and delivery time
 2. Submit samples for review of size, kind, color, pattern, texture, and lead content testing for all paints and painted materials. Submit Samples for a final check of these characteristics with other elements and a comparison of these characteristics between the final submittal and the actual component as delivered and installed.
 - a. Where variation in color, pattern, texture or other characteristic is inherent in the material or product represented, submit at least three (3) multiple units that show approximate limits of the variations.

SECTION 01300 – SUBMITTALS

- b. Refer to other specification sections for requirements for samples that illustrate workmanship, fabrication techniques, details of assembly, connections, operation and similar construction characteristics.
 - c. Refer to other sections for samples to be returned to the Contractor for incorporation in the work. Such samples must be undamaged at time of use. On the transmittal, indicate special requests regarding disposition of sample submittals.
 - d. Samples not incorporated into the work, or otherwise designated as the Owner's property, are the property of the Contractor and shall be removed from the site prior to Substantial Completion.
 - e. Samples that are tested by WCSO to have any lead content shall be rejected.
 3. Preliminary Submittals: Submit a full set of choices where samples are submitted for selection of color, pattern, texture or similar characteristics from a range of standard choices.
 - a. The Architect will review and return preliminary submittals with the Architect's notation, indicating selection and other action.
 4. Submittals: Except for samples illustrating assembly details, workmanship, fabrication techniques, connections, operation and similar characteristics, submit three (3) sets. The Architect will return one set marked with the action taken.
 5. Maintain sets of samples, as returned, at the project site, for quality comparisons throughout the course of construction.
 - a. Unless non-compliance with contract document provisions is observed, the submittal may serve as the final submittal.
 - b. Sample sets may be used to obtain final acceptance of the construction associated with each set.
- B. Distribution of Samples: Prepare and distribute additional sets to sub-contractors, manufacturers, fabricators, suppliers, installers and others as required for performance of the work. Show distribution on transmittal forms.
 1. Field samples are full size examples erected on site to illustrate finishes, coatings or finish materials and to establish the project standard.
 - a. Comply with submittal requirements to the fullest extent possible. Process transmittal forms to provide a record of activity.

1.10 QUALITY ASSURANCE SUBMITTALS

SECTION 01300 – SUBMITTALS

- A. Submit quality control submittals, including design data, certifications, manufacturer's instructions, manufacturer's field reports and other quality control submittals as required under other sections of the specifications.
- B. Certifications: Where other sections of the specifications require certification that a product, material or installation complies with specified requirements, submit a notarized certification from the manufacturer certifying compliance with specified requirements.
 - 1. Signature: Certification shall be signed by an officer of the manufacturer or other individual authorized to sign documents on behalf of the company.
- C. Inspection and Test Reports: Requirements for submittal of inspection and test reports from independent testing agencies are specified in Division 1 SECTION 01400 – QUALITY CONTROL.

1.11 ARCHITECT'S ACTION

- A. Except for submittals for the record or information, where action and return is required, the Architect will review each submittal, mark to indicate action taken and return promptly.
 - 1. Compliance with specified characteristics is the Contractor's responsibility.
- B. Action Stamp: The Architect will stamp each submittal with a uniform, action stamp. The Architect will mark the stamp appropriately to indicate the action taken, as follows:
 - 1. Final Unrestricted Release: When the Architect marks a submittal "No Exceptions Taken," the work covered by the submittal may proceed provided it complies with requirements of the contract documents. Final payment depends on that compliance.
 - 2. Final-But-Restricted Release: When the Architect marks a submittal "Implement Exception Noted," the work covered by the submittal may proceed provided it complies with notations or corrections on the submittal and requirements of the contract documents. Final payment depends on that compliance.
 - 3. Returned for Resubmittal: When the Architect marks a submittal "Not Approved, Revise and Resubmit," do not proceed with work covered by the submittal, including purchasing, fabrication, delivery or other activity. Revise or prepare a new submittal according to the notations; resubmit without delay. Repeat if necessary to obtain different action mark.

SECTION 01300 – SUBMITTALS

- a. Do not use, or allow others to use, submittals marked "Not Approved, Revise and Resubmit" at the project site or elsewhere where work is in progress.
 - b. When the submittal review action stamp is marked "Rejected", do not proceed with that portion of the work covered by the submittal including, but not limited to, purchasing, fabrication, delivery or other activity. Make a new submittal in accordance with the review notations on the submittal and resubmit without delay in the same manner and number as for the original submittal. Resubmit as often as necessary as required to obtain an unrestricted or restricted release action. "Rejected" review action stamp notation shall not be construed by the Contractor as a valid reason for an increase in contract time.
4. Other Action: Where a submittal is for information or record purposes or special processing or other activity, the Architect will return the submittal marked "Action Not Required."
- C. Unsolicited Submittals: The Architect will return unsolicited submittals to the sender without action.

PART 2 – PRODUCTS (Not Applicable)

PART 3 – EXECUTION (Not Applicable)

END OF SECTION 01300

SECTION 01310A – PROGRESS SCHEDULES

PART 1 - GENERAL

1.1 THIS SECTION INCLUDES:

- A. Schedule Submittal Requirements
- B. Schedule Submittal Format
- C. CPM Schedule Structural Requirements
- D. Updating Schedules
- E. Schedule Revisions
- F. Time Extensions
- G. Three (3) Week Projection Schedule

1.2 RELATED SECTIONS

- A. Division 1 SECTION 01010 – SUMMARY OF WORK
- B. Schedule of Values
- C. Division 1 SECTION 01027 – APPLICATION FOR PAYMENT
- D. Change Order Procedures
- E. Division 1 SECTION 01300 – SUBMITTALS

1.3 SCHEDULE SUBMITTAL REQUIREMENTS

- A. Submit, in duplicate, as described in Part 1.5 A., to the Owner and the Architect at the Pre-Construction Conference the following preliminary documents defining planned operations:
 - 1. Baseline Schedule
- B. The Architect and the Owner will review schedule submittals; such review shall not constitute an approval or acceptance of the Contractor's construction means, methods, sequencing or its ability to complete the work in a timely manner.
- C. The preliminary documents will illustrate, at a minimum, a detailed baseline schedule for those activities commencing within the first ten (10) calendar days after the Notice to Proceed is issued by the Owner.

SECTION 01310A – PROGRESS SCHEDULES

- D. The Contractor shall submit the completed Baseline documents to the Architect within thirty (30) calendar days from the Notice of Award. The schedules shall integrate the activities of the preliminary schedules, and include all activities required for contract completion.
1. Within fifteen (15) calendar days after receipt of the complete Baseline Schedule, the Owner and Architect will communicate in writing their comments and concerns to the Contractor. Within five (5) working days, the Contractor shall adjust the schedule and progress curve to incorporate comments from the Owner and Architect and resubmit.
 2. Upon Owner and Architect receipt and acknowledgment of revisions to the Baseline Schedule, it shall become part of the contract documents. Payment to the Contractor shall be withheld until such schedule, satisfactory in form and substance to the Owner and Architect, has been received.
- E. Changes in logic and/or durations shall not be made without first noticing on the need to change with the Owner and Architect. Changes will be accepted where they are reasonable. Changes will be accepted or denied without liability. Changes to simply accommodate a perception of still being on schedule will not be accepted. At the discretion of the Architect and the Owner, the Baseline Schedule no longer represents the actual prosecution and progress of the work, the Architect and Owner will require a Recovery Schedule.
- F. Failure to provide the required schedule information at the required times will result in denial of the relative portion of progress payments until such time that the schedule information is submitted in the correct format at the sole option of the Owner.

1.4 SCHEDULE SUBMITTAL FORMAT

- A. Follow the guidelines below when submitting a baseline, update, or projection schedule.
1. Required Diagrams:
 - a. Gantt/Bar Chart or Time Scaled Logic Diagram; sheet size to be a maximum of 30 x 42 inches, organized by building and/or area, sorted by early start and early finish dates.
 - b. The formatting of the (hard copy submission) Baseline Schedule, schedule updates and three (3) week projection schedules shall include the following information (order and content of columns):
 - i. Activity Description
 - ii. Original Duration

SECTION 01310A – PROGRESS SCHEDULES

- iii. Remaining Duration
 - iv. Percent Complete
 - v. Total Float
 - vi. Target Early Start (except on Baseline Schedule)
 - vii. Target Early Finish (except on Baseline Schedule)
 - viii. On all updates and projections, show Baseline Schedule as Target (with Target Early Start and Target Early Finish dates)
 - ix. Format title block to include (at a minimum) the Contractor's name, school name, project number, file name, data date and run date.
- c. The Contractor will be responsible for planning, scheduling, managing, and reporting the progress of the work in accordance with all of the specific methods and submittals described in this section.
 - d. The construction schedule shall be prepared by a competent scheduler, and used by the Contractor to plan, prosecute and coordinate the work in an orderly and expeditious manner. The schedule will be used by the Owner and the Architect to evaluate progress and status at the various stages of the project, allocate funds, determine the impact of any changes to the Contract and establish the basis for progress payments.

1.5 CPM SCHEDULE STRUCTURAL REQUIREMENTS

- A. The following requirements have been defined in an effort to create consistency across all project schedules for purpose of analysis.
 - 1. Structure of Schedule:
 - a. The schedule should be broken down into logical areas of work. We suggest separate areas of the building and that sitework be divided into appropriate areas. We expect to see, at a minimum, the following areas (where applicable):
 - i. Milestones
 - ii. Prepare & Issue Submittals
 - iii. Review Submittals
 - iv. Material Procurement & Delivery
 - v. On Site Work
 - vi. Off Site Work
 - vii. Area A
 - viii. Area B
 - ix. Area C
 - x. Area D
 - xi. Plant

SECTION 01310A – PROGRESS SCHEDULES

- xii. Etc.
- b. Tasks related to the submittal/procurement of material or equipment shall be included as separate activities in the project schedule. Examples of procurement activities include, but are not limited to:
 - i. Material/Equipment submittal preparation
 - ii. Submittal and approval of material/equipment
 - iii. Delivery of O&M manuals
 - iv. Material/equipment fabrication and delivery
 - v. Delivery of extra parts/extra stock/special tools
 - vi. Notification of Owner furnished materials/equipment delivery requirements
 - vii. Contractor's original network diagram submittal shall become the Baseline Schedule, once it is found acceptable by the Owner. The Baseline Schedule shall be duplicated and utilized as the Current Schedule and shown graphically over the Baseline.
- c. Construction activities shall include at a minimum, but are not limited to:
 - i. Tasks corresponding to each specification section covered in the Specification Index in Divisions 2 through 16
 - ii. Tasks related to mobilization / demobilization
 - iii. Tasks related to Owner; Owner provide materials, FFE delivery and setup, Move in prior to substantial and final completion
 - iii. The installation of temporary or permanent work by tradesman
 - iv. Testing and inspections of installed work by technicians, inspectors, or engineers
 - v. System utility outages and tie ins
 - vi. Start up and testing of equipment, commissioning of building and related systems
 - vii. Scheduling of specified manufacturer's representatives
 - viii. Final clean up
 - ix. Training to be provided
 - x. Punch list completion
 - xi. Maintenance period
 - xii. Administrative tasks necessary to start, proceed with, accomplish or finalize the contract

1.6 UPDATING SCHEDULES

- A. Updated Schedules shall accompany the monthly Application for Payment, reflecting progress since previous month's submittal.

SECTION 01310A – PROGRESS SCHEDULES

- B. The schedule update shall show the status of all activities, including those in progress, completed or not started, indicated by start and finish dates, whether forecasted or actual, completion percentages based on time, original and remaining durations, any changes in network logic or activity durations and any other relevant information. Refer to Part 1.8 for revisions to the Schedule.
- C. Identify activities modified since previous submittal, major changes in work, changes associated with approved Change Orders and any other identifiable changes.
- D. Actual start and finish dates shall not be automatically updated by default mechanisms that may be included in the CPM scheduling software system. Actual start and actual finish dates on the CPM schedule shall match the dates of actual work accomplished in the field and not on projected completion dates. Out of sequence progress (if applicable) shall be handled through Retained Logic, not the option of Progress override.
- E. With each updated schedule submission, the Contractor shall submit a brief narrative report, including descriptions of schedule revisions such as changes in network logic, planned activity start dates, duration or in the critical path. The report will include a description of the amount of progress during the last month, a description of any problem areas, current or anticipated delays and their estimated schedule impacts. In the narrative report, the Contractor shall provide explanation for any slippage in contractual completion or other milestone dates. Additionally, the Contractor shall propose remedial measures necessary to recover any lost time, whether actual or forecasted. Contractor shall take such additional steps as are necessary in order to effectively eliminate or minimize such delays and to comply with the contract schedule.

1.7 SCHEDULE REVISIONS

- A. Updating the schedule to reflect actual progress made up to the data date of a schedule update shall not be considered revisions to the Baseline Schedule.
- B. If, as a result of a schedule update, it appears the baseline schedule no longer represents the actual prosecution and progress of the work, the Architect or Owner shall request a revised schedule from the Contractor. The revision shall address the Contractor's current construction plan for completing the work without impacting contract time and cost. Approved

revisions to the schedule shall be incorporated into the Baseline Schedule at the next schedule update submission.
- C. If the Architect or Owner recognizes at any time, regardless of, reason that the work has fallen behind the scheduled contract time, milestone, phase dates or for work activity on the latest schedule that indicates more than a critical five (5) day delay to

SECTION 01310A – PROGRESS SCHEDULES

the project, the Contractor shall submit a written and documented Recovery Schedule within seven (7) calendar days of the Architect's/Owner's written request. The Contractor will document in the Recovery Schedule and narrative, all additional resources, including materials equipment and labor and modifications of operations which will be provided so as to meet the schedule. The Contractor will provide all such additional resources and modifications of operations without additional cost to the Owner. Such additional resources and modifications shall include but not be limited to:

1. Required overtime for the Contractor's personnel
2. Increased construction manpower in such quantities as will substantially eliminate the backlog of work and put the project back on schedule
3. Increase numbers of shifts per working day, working days per week or the amount of construction equipment or any combination of the foregoing which will put the project back on schedule
4. Reschedule activities to achieve the maximum practical concurrence of accomplishment of activities to put the project back on schedule
5. Supplemental progress schedules detailing the specific operation changes instituted to regain the contract schedule

The Contractor will implement the Recovery Schedule without additional cost to the Owner and provide for completion of the work in accordance with the remaining milestone dates without a time extension. Should the logic and/or durations of the Recovery Schedule not receive acceptance of the Architect and the Owner, the Contractor is responsible to use concurrent operations, additional manpower, additional shifts, overtime, etc., including 24 hour production work day, seven (7) day work week operation, as required to put the project back on schedule at no additional cost to the Owner.

- D. The Contractor may also request revisions to the Baseline Schedule in the event the Contractor's planning for the work is revised. If the Contractor desires to make changes in the Baseline Schedule to reflect revisions in its method of operating and scheduling of the work, the Contractor shall notify the Architect and Owner in writing stating the reason for the proposed revisions and accompanied by a copy of the Contractor's electronic CPM Schedule. The revision shall address the Contractor's current construction plan for completing the work without impacting contract time and cost. Accepted revisions to the schedule shall be incorporated into the Baseline Schedule at the next schedule update submission.
- E. If changes in the method of operation and scheduling are desired, the Owner and/or Architect shall be notified in writing stating the reasons for the change. If the Owner and/or Architect considers these changes to be of a major nature, the Contractor

SECTION 01310A – PROGRESS SCHEDULES

may be required to revise and submit for acceptance, without additional cost to the Owner, the network diagrams and required sorts. A change may be considered of a major nature if the estimated time required or actually used for an activity or the network logic is varied from the original plan to a degree that there is a reasonable doubt as to the effect on the contract completion date(s) (or phase completion dates). Changes that affect activities with adequate float time shall be considered a major change when their cumulative effect could extend the contract completion dates.

- F. Use of float suppression techniques, such as:
1. Preferential sequencing (arranging critical path through activities more susceptible to Owner and/or Architect caused delay);
 2. Special lead/lag logic restraints;
 3. Zero total or free float constraints;
 4. Extended activity times, or imposing constraint dates other than as required by the contract;

shall be cause for rejection of the project schedule or its updates. The use of resource Leveling (or similar software features) used for the purpose of artificially adjusting activity durations to consume float and influence the critical path is expressly prohibited.

- G. Definitions of Float or Slack
1. Free float is the length of time the start of an activity can be delayed without delaying the start of a successor activity.
 2. Total float is the length of time along a given network path that the actual start and finish of activity(ies) can be delayed without delaying the project completion date.
 3. Project float is the length of time between the Contractor's early completion (or Substantial Completion) and the contract completion date.
 4. Project float is for the benefit of the project and for the mutual use of the Owner and the Contractor.
 5. Contractor's non-work weather days bank of time activity shall not be defined as "Float or Slack" for this project. It is Contractor time identified in item 1.9.G which follows.
- H. Negative float will not be a basis for requesting time extensions. Any extension of time will be addressed in accordance with item 1.9 Time Extensions. Scheduled

SECTION 01310A – PROGRESS SCHEDULES

completion dates(s) that extend beyond the contract (or phase) completion date(s) (evidenced by negative float) may be used in computation for assessment of payment withholdings. The use of this computation is not to be construed as a means of acceleration.

1.8 TIME EXTENSIONS

- A. Extensions of time to the Contract may be granted only for delays to activities on the critical path that actually delay the project completion beyond the date of Substantial Completion or for delays to activities that transform that activity onto the critical path, and, as a result, delay completion beyond the contract Substantial Completion date.
- B. Seasonal weather conditions and resulting impacts shall be included in the planning and scheduling of all work influenced by wind, cold or warm weather, smoke, snow, and/or precipitation to ensure completion of all work within the Contract time.

If all the work, or the portion(s) of the work which are the currently controlling operation(s), are suspended for weather so as not to prosecute the work, a time extension at the Owners discretion, **may be awarded if the following conditions are satisfied**

- a. The weather shall actually be the delay to the Substantial Completion Date of the project and the delay must be beyond the control and without the fault or negligence of Contractor; weather will be evaluated based on the original baseline schedule without revision if revision is the result of contractor performance; **and**
- b. The weather recorded by NOAA / NWS (WS Form: F6) website: (www.weather.gov/climate/index), Reno location or owner approved location of work during the Contract period shall be found to occur more frequently than the weather normally recorded by NOAA / NWS to be anticipated is documented more frequently occurring than 5 Year NOAA / NWS (WS Form: F6) Averages for all project locations; or
- c. Owner/Architect orders the stoppage or suspension of the work in the interest of public safety or health or due to specification requirements.

Weather is defined for the purposes of this Contract to be compared to current recorded National Oceanic and Atmospheric Administration (NOAA) / National Weather Service Preliminary Local Climatological Data (WS FORM: F-6) for Station: Reno, Nevada, or for owner approved alternate project location, as follows:

- **PRECIPITATION** water equivalent of greater than or equal to 0.1 inch

SECTION 01310A – PROGRESS SCHEDULES

- recorded for the 24-hour period, of the date, and /or
- **AVERAGE** wind speed of greater than or equal to 20 miles per hour recorded for the 24-hour period for the date of occurrence. **NOT** 2 Minute Sustained or Gusts as recorded in (WS FORM:F6).

The schedule of anticipated weather delays is based on current National Oceanic and Atmospheric Administration (NOAA) / National Weather Service (NWS) records kept as Preliminary Local Climatological Data (WS FORM: F-6) for Station: Reno, Nevada, (e.g. 5 Year NOAA / NWS (WS Form: F6) Averages) for all project locations **and will constitute the baseline for the total Contract Time weather delay evaluations.** Contractor's CPM schedule shall be understood to include as a minimum, the amount of weather delay days lost in all Contractors' weather dependent activities occurring during the activity.

1.9 THREE (3) WEEK PROJECTION SCHEDULE

- A. As deemed necessary by the Owner or Architect, the Contractor shall provide a three (3) week detailed short interval schedule for each building story, and area of the work, at regularly scheduled progress meetings. The format shall be satisfactory to the Owner and Architect. Short interval schedules shall be based upon the most current precedence Network Diagram and will indicate the actual progress achieved the previous week as well as the detailed activities scheduled for the next two (2) weeks and will show anticipated durations, start and completion dates for activities, and how the schedule tracks to the baseline schedule. All projection schedules shall be derived from the baseline schedule.

PART 2 – PRODUCTS (NOT USED)

PART 3 – EXECUTION (NOT USED)

END OF SECTION 01310A

SECTION 01400 – QUALITY CONTROL

PART 1 - GENERAL

1.1 RELATED DOCUMENTS

- A. Drawings and general provisions of the Contract, including all contract documents and addendums associated with this project shall apply to this section.

1.2 SUMMARY

- A. This section includes administrative and procedural requirements for quality control services.
- B. Quality control services include inspections, tests and related actions, including reports performed by the Contractor, by independent agencies and by governing authorities. They do not include contract enforcement activities performed by the Architect.
- C. Inspection and testing services are required to verify compliance with requirements specified or indicated. These services do not relieve the Contractor of responsibility for compliance with contract document requirements.
- D. Requirements of this section relate to customized fabrication and installation procedures, not production of standard products.
 - 1. Specific quality control requirements for individual construction activities are specified in the sections that specify those activities. Requirements in those sections may also cover production of standard products.
 - 2. Specified inspections, tests and related actions do not limit the Contractor's quality control procedures that facilitate compliance with contract document requirements.
 - 3. Requirements for the Contractor to provide quality control services required by the Architect, Owner or Authorities Having Jurisdiction (AHJ) are not limited by provisions of this section.
- E. Related Sections: The following sections contain requirements that relate to this section:
 - 1. Division 1 SECTION 01045 – CUTTING AND PATCHING specifies requirements for repair and restoration of construction disturbed by inspection and testing activities.
 - 2. Division 1 SECTION 01300 – SUBMITTALS specifies requirements for development of a schedule of required tests and inspections.

SECTION 01400 – QUALITY CONTROL

1.3 RESPONSIBILITIES

- A. Owners Responsibilities: Unless otherwise indicated as the responsibility of another identified entity, the Owner or Owners representatives/agents, project managers, QA/QC inspectors, coordinators etc. shall provide inspections, tests and other quality control services specified elsewhere in the contract documents and required by AHJ.
1. Where individual sections specifically indicate that certain inspections, tests and other quality control services are the Contractor's responsibility, the Contractor shall employ and pay a qualified independent testing agency to perform quality control services. Costs for these services are included in the contract sum.
 2. Where individual sections specifically indicate that certain inspections, tests and other quality control services are the Owner's responsibility, the Owner will employ and pay a qualified independent testing agency to perform those services.
 - a. Where the Owner has engaged a testing agency for testing and inspecting part of the work and the Contractor is also required to engage an entity for the same or related element, the Contractor shall not employ the entity engaged by the Owner, unless agreed to in writing by the Owner.
- B. Retesting: The Contractor is responsible for retesting where results of inspections, tests or other quality control services prove unsatisfactory and indicate non-compliance with contract document requirements, regardless of whether the original test was the Contractor's responsibility.
1. The cost of retesting construction, revised or replaced by the Contractor, is the Contractor's responsibility where required tests performed on original construction indicated non-compliance with contract document requirements.
- C. Associated Services: Cooperate with agencies performing required inspections, tests and similar services and provide reasonable auxiliary services as requested. Notify the agency sufficiently in advance of operations to permit assignment of personnel. Auxiliary services required include, but are not limited to, the following:
1. Provide access to the work.
 2. Furnish incidental labor and facilities necessary to facilitate inspections and tests.

SECTION 01400 – QUALITY CONTROL

3. Take adequate quantities of representative samples of materials that require testing or assist the agency in taking samples.
 4. Provide facilities for storage and curing of test samples.
 5. Deliver samples to testing laboratories.
 6. Provide the agency with a preliminary design mix proposed for use for materials mixes that require control by the testing agency.
 7. Provide security and protection of samples and test equipment at the project site.
- D. Duties of the Testing Agency: The independent agency engaged to perform inspections, sampling and testing of materials and construction specified in individual sections shall cooperate with the Architect and the Contractor in performance of the agency's duties. The testing agency shall provide qualified personnel to perform required inspections and tests.
1. The agency shall notify the Architect and the Contractor promptly of irregularities or deficiencies observed in the work during performance of its services.
 2. The agency is not authorized to release, revoke, alter or enlarge requirements of the contract documents or approve or accept any portion of the work.
 3. The agency shall not perform any duties of the Contractor.
- E. Coordination: Coordinate the sequence of activities to accommodate required services with a minimum of delay. Coordinate activities to avoid the necessity of removing and replacing construction to accommodate inspections and tests.
1. The Contractor is responsible for scheduling times for inspections, tests, taking samples and similar activities. The Contractor will also be responsible for standby charges from the Owner's laboratory if they are due to a scheduling error by the Contractor.

1.4 SUBMITTALS

- A. Unless the Contractor is responsible for this service, the independent testing agency shall submit a certified written report, in duplicate, of each inspection, test or similar service to the Architect. If the Contractor is responsible for the service, submit a certified written report, in duplicate, of each inspection, test or similar service through the Contractor.

SECTION 01400 – QUALITY CONTROL

1. Submit additional copies of each written report directly to the governing authority, when the authority so directs.
2. Report Data: Written reports of each inspection, test, or similar service include, but are not limited to, the following:
 - a. Date of issue
 - b. Project title and number
 - c. Name, address and telephone number of testing agency
 - d. Dates and locations of samples and tests or inspections
 - e. Names of individuals making the inspection or test
 - f. Designation of the work and test method
 - g. Identification of product and specification section
 - h. Complete inspection or test data
 - i. Test results and an interpretation of test results
 - j. Ambient conditions at the time of sample taking and testing
 - k. Comments or professional opinion on whether inspected or tested work complies with the contract document requirements
 - l. Name and signature of laboratory inspector
 - m. Recommendations on retesting

1.5 QUALITY ASSURANCE

- A. Qualifications for Service Agencies: Engage inspection and testing service agencies, including independent testing laboratories, that are prequalified as complying with the American Council of Independent Laboratories' *Recommended Requirements for Independent Laboratory Qualification* and that specialize in the types of inspections and tests to be performed.
 1. Each independent inspection and testing agency engaged on the project shall be authorized by AHJ to operate in the State of Nevada.

PART 2 - PRODUCTS (Not Applicable)

PART 3 - EXECUTION

3.1 REPAIR AND PROTECTION

- A. General: Upon completion of inspection, testing, sample taking and similar services, repair damaged construction and restore substrates and finishes. Comply with the contract document requirements for Division 1 SECTION 01045 – CUTTING AND PATCHING
- B. Protect construction exposed by or for quality control service activities and protect repaired construction.

SECTION 01400 – QUALITY CONTROL

- C. Repair and protection is the Contractor's responsibility, regardless of the assignment of responsibility for inspection, testing or similar services.

END OF SECTION 01400

SECTION 01420 – REFERENCES

PART 1 - GENERAL

1.1 DESCRIPTION

- A. This section includes abbreviations and acronyms, additional definitions, and reference standards used in the contract documents.
- B. Refer to Drawings and general provisions of the Contract, including all contract documents and addendums associated with this project for further information.

1.2 ABBREVIATIONS AND ACRONYMS

- A. The following abbreviations and acronyms may be used in the contract documents. Refer uncertainties to the Architect for a decision before proceeding.

AA	Aluminium Association
AAADM	American Association of Automatic Door Manufacturers
AAMA	Architectural Aluminum Manufacturers' Association
AASHTO	American Association of State Highway and Transportation Officials
AATCC	American Association of Textile Chemists and Colorists
ACI	American Concrete Institute
ADA	Americans with Disabilities Act
AFPA	American Forest and Paper Association
AIA	American Institute of Architects
AIMA	Acoustical and Insulation Materials Association
AISC	American Institute of Steel Construction
AMCA	American Movement and Control Association
ANSI	American National Standards Institute
APA	The Engineered Wood Association (formerly the American Plywood Association)
ARI	Air Conditioning and Refrigeration Institute
ASA	American Standards Association
ASHRAE	American Society of Heating, Refrigerating, and Air-Conditioning Engineers
ASME	American Society of Mechanical Engineers
ASTM	American Society for Testing and Materials
AWI	Architectural Woodwork Institute
AWPA	American Wood Preservers' Association
AWWA	American Water Works Association
AWS	American Welding Society
BHMA	Builders Hardware Manufacturers' Association
BIA	Brick Institute of America
CAL/OSHA	State of California Construction Safety Orders
CALTRANS	State of California, Business and Transportation Agency,

SECTION 01420 – REFERENCES

	Department of Transportation, <i>Standard Specifications</i>
CCR	California Code of Regulations
CDA	Copper Development Association
CISCA	Ceilings and Interior Systems Construction Association
CFFA	Chemical Fabrics and Film Association, Inc.
CFMG	Cabinet and Fixture Manufacturers Guild
CLFMI	Chain Link Fence Manufacturers' Institute
CPA	Composite Panel Association (formerly the National Particleboard Association)
CRI	Carpet and Rug Institute
CRSI	Concrete Reinforcing Steel Institute
CPSC	United States Consumer Products Safety Commission
CS	Commercial Standard, United States Department of Commerce
CSA	Canadian Standards Association
DASMA	Door and Access Systems Manufacturers Association International
EIMA	EIFS Industry Members Association
EPA	Environmental Protection Agency
ESO	Electrical Safety Orders
FAA	Federal Aviation Administration, United States Department of Transportation
FCC	Federal Communications Commission
FGMA	Flat Glass Marketing Association (now the GANA)
FM	Factory Mutual System, Factory Mutual Engineering Corporation
FS	Federal Specification Unit
GA	Gypsum Association
GANNA	Glass Association of North America (formerly the Flat Glass Marketing Association and Glass Tempering Association)
GRI	Geosynthetic Research Institute
GTA	Glass Tempering Association (now the GANA)
HMA	Hardwood Manufacturers Association
HPMA	Hardwood Plywood Manufacturers Association
HPVA	Hardwood Plywood and Veneer Association
HUD	United States Department of Housing and Urban Development
IEEE	Institute of Electrical and Electronic Engineers
IGCC	Insulating Glass Certification Council
ITS-WH	Intertek Testing Service - Warnock Hersey
LSGA`	Laminator's Safety Glass Association
MIA	Marble Institute of America or the Masonry Institute of America

SECTION 01420 – REFERENCES

MIL	Military Standardization Document, United States Department of Defense
MIW	Masonry Institute of Washington
ML/SFA	Metal Lath/Steel Framing Association
MM	“Materials Manual”, State of California, Business and Transportation Agency, Department of Transportation
NAAMM	National Association of Architectural Metal Manufacturers
NBGQA	National Building Granite Quarries Association, Inc.
NBS	National Bureau of Standards (now the NIST)
NCMA	National Concrete Masonry Association
NEC	National Electrical Code
NEMA	National Electric Manufacturers' Association
NFPA	National Fire Protection Association
NFPA	National Forest Products Association (now the AFPA)
NFRC	National Fenestration Rating Council
NHLA	National Hardwood Lumber Association
NIST	National Institute of Standards and Technology, United States Department of Commerce (formerly the National Bureau of Standards)
NOFMA	National Oak Flooring Manufacturers Association
NPDES	National Pollutant Discharge Elimination System
NRCA	National Roofing Contractors Association
NSF	NSF International (formerly National Sanitary Foundation)
NTMA	National Terrazzo and Mosaic Association
NWWDA	National Wood Window and Door Association (now WDMA)
OSA	Office of the State Architect, State of California
OSHPD	Office of Statewide Health Planning and Development, State of California
PCI	Precast / Prestressed Concrete Institute
PS	Product Standard, United States Department of Commerce
RCW	Revised Code of Washington, State of Washington
RIS	Redwood Inspection Service
SDI	Steel Deck Institute or the Steel Door Institute
SFM	Office of State Fire Marshal, State of California
SIGMA	Sealed Insulated Glass Manufacturer's Association
SMACNA	Sheet Metal and Air Conditioning Contractors National Association
SSPC	Society for Protective Coatings (formerly the Steel Structures Painting Council)
SWI	Steel Window Institute
TCA	Tile Council of America

SECTION 01420 – REFERENCES

UBC	Uniform Building Code
UFC	Uniform Fire Code
UL	Underwriters Laboratories, Inc.
UMC	Uniform Mechanical Code
UPC	Uniform Plumbing Code
USPS	United States Postal Service
USS	United States Standard
WAC	Washington Administrative Code, State of Washington
WCLIB	West Coast Lumber Inspection Bureau
WDMA	Window and Door Manufacturers Association (formerly the National Wood Window and Door Association)
WIC	Woodwork Institute of California
WLPDIA	Western Lath Plaster /Drywall Industries Association (now the WWCCA)
WSDOT	Washington State Department of Transportation
WWCCA	Western Wall & Ceiling Contractors Association
WWPA	Woven Wire Products Association or Western Wood Products Association

- B. Additional abbreviations, used only on the drawings, are listed and defined thereon.

USE SECTION 1.03 ONLY IF THESE DEFINITIONS ARE NOT INCLUDED IN THE GENERAL CONDITIONS FOR THE SPECIFIC CONTRACT.

1.03 ADDITIONAL DEFINITIONS

- A. In addition to the terms defined in the General Conditions, the following terms are used in the contract documents and are defined as follows:

Accepted Equal	As accepted by the Architect as being of equivalent quality, utility and appearance.
Addenda	Written or graphic instruments issued by the Owner/Architect prior to the execution of the Contract which modify or interpret the bidding documents by additions, deletions, clarifications or corrections.
By Owner	Work on this project that will be performed by the Owner or its agents, at the Owner's cost.
By Others	Work on this project that is outside the Scope of Work to be performed by the Contractor under this Contract, but that will be performed by the Owner, other contractors or other means.
Consultant Directed	A consultant to the Architect Directed by the Architect

SECTION 01420 – REFERENCES

Furnish Indicated	Supply only; do not install
Install	As shown and/or noted on the drawings
Owner-Furnished, Contractor-Installed	Install or apply only; do not furnish
Project Manual	The Owner will furnish at their cost and the Contractor shall install under their contract for this work.
	The Project Manual consists of two volumes: Volume 1 includes the bidding and contract requirements and Specifications; and Volume 2 includes the details and schedules. One volume which includes the bidding and contract requirements and specifications and the details and schedules.
Provide Site Specified	Furnish and install
	Geographical location of the project
	As written in the specifications

1.4 REFERENCE STANDARDS

- A. Specified standards of the construction industry shall have the same force and effect on the performance of the work as if bound or copied directly into the contract documents. Such standards are made a part of the contract documents by reference.
- B. Each entity or person engaged in the work shall be familiar with the industry standards applicable to its construction activity.
- C. Where compliance with two (2) or more standards is specified and the standards establish different or conflicting requirements for minimum qualities or quality levels, comply with the most stringent requirement. Refer uncertainties and requirements that are different, but apparently equal, to the Architect for a decision before proceeding.
- D. Copies of applicable standards are not bound with the contract documents. Where copies are required for proper performance of the work, obtain and pay for authorized copies directly from publication source and maintain at the site during submittals, planning and performance of work until final acceptance by the Owner. Make such copies of standards available to the Owner and Architect for review upon request.
- E. For products or quality of installation specified by association, trade, military, federal or other reference standards, comply with requirements of the standard, except when more rigid requirements are specified in the contract documents or are required by applicable codes and/or public Authorities Having Jurisdiction (AHJ).
 - 1. Except as otherwise indicated or specified, where compliance with a reference standard is required, comply with the standard in effect as of the

SECTION 01420 – REFERENCES

date established for the receipt of bids. Where a reference standard has been revised and reissued after the date established for the receipt of bids and before performance of the work affected, notify the Architect in writing and request a decision on how to proceed. The Architect may issue a contract modification or an Architect's Supplemental Instruction (ASI) for proceeding in accordance with the updated standard.

2. The contractual relationship of the parties to the Contract shall not be altered from the contract documents by mention or inference otherwise in a reference standard. The provisions of the bidding requirements; contract documents including, but not limited to all issued addendums; and the Contract shall void the general, but not technical, provisions of a reference standard in conflict therewith.

PART 2 – PRODUCTS (Not Used)

PART 3 – EXECUTION (Not Used)

END OF SECTION 01420

SECTION 01600 – MATERIALS AND EQUIPMENT

PART 1 – GENERAL

1.1 RELATED DOCUMENTS

- A. Drawings and general provisions of the Contract, including all contract documents and addendums associated with this project shall apply to this section.

1.2 SUMMARY

- A. This section includes administrative and procedural requirements governing the Contractor's selection of products for use in the project.
- B. Related Sections: The following sections contain requirements that relate to this Section:
 - 1. Division 1 SECTION 01420 - REFERENCES specifies the applicability of industry standards to products specified.
 - 2. Division 1 SECTION 01300 – SUBMITTALS specifies requirements for submittal of the Contractor's construction schedule and the submittal schedule.
 - 3. Division 1 SECTION 01631 – SUBSTITUTIONS specifies administrative procedures for handling requests for substitutions made after award of the contract.

1.3 DEFINITIONS

- A. Definitions used in this section are not intended to change the meaning of other terms used in the contract documents such as *Specialties*, *Systems*, *Structure*, *Finishes*, *Accessories* and similar terms. Such terms are self-explanatory and have well recognized meanings in the construction industry.
 - 1. *Products* are items purchased for incorporation in the work, whether purchased for the project or taken from previously purchased stock. The term *Product* includes the terms *Material*, *Equipment*, *System* and terms of similar intent.
 - a. *Named Products* are items identified by the Manufacturer's product name, including make and model number or other designation, shown or listed in the Manufacturer's published product literature that is current as of the date of the contract documents.
 - b. *Foreign Products* as distinguished from domestic products are items substantially manufactured fifty percent [(50%) or more of value] outside the United States and its possessions. Products produced or supplied by entities substantially owned [more than fifty percent (50%)] by persons who are not citizens of, nor living within, the United States and its possessions.

SECTION 01600 – MATERIALS AND EQUIPMENT

2. *Materials* are products substantially shaped, cut worked, mixed, finished, refined or otherwise fabricated, processed or installed to form a part of the work.
3. *Equipment* is a product with operational parts, whether motorized or manually operated, that requires service connections, such as wiring or piping.

1.4 SUBMITTALS

- A. Product List: A list of products required is included at the end of this section. Prepare a schedule in tabular form showing each product listed. Include the Manufacturer's name and proprietary product names for each item listed.
1. Coordinate product list with the Contractor's construction schedule and the schedule of submittals.
 2. Form: Prepare product list with information on each item tabulated under the following column headings:
 - a. Related Specification Section Number
 - b. Generic name used in the contract documents
 - c. Proprietary Name, Model Number and similar designations
 - d. Manufacturer's Name and Address
 - e. Supplier's Name and Address
 - f. Installer's Name and Address
 - g. Projected Delivery Date or time span of delivery period
 3. Initial Submittal: Within thirty (30) days after date of commencement of the work, submit three (3) copies of an initial product list. Provide a written explanation for omissions of data and for known variations from the contract requirements.
 - a. At the Contractor's option, the initial submittal may be limited to product selections and designations that must be established early in the contract period.
 4. Completed List: Within sixty (60) days after date of commencement of work, submit three (3) copies of the completed product list. Provide a written explanation for omissions of data and for known variations from the contract requirements.
 5. Architect's Action: The Architect will respond in writing to Contractor within two (2) weeks of receipt of the completed product list. No response within this period constitutes no objection to listed manufacturers or products but does not constitute a waiver of the requirement that products comply with the contract documents. The Architect's response will include a list of unacceptable product selections containing a brief explanation of reasons for this action.

SECTION 01600 – MATERIALS AND EQUIPMENT

1.5 QUALITY ASSURANCE

- A. Source Limitations: To the fullest extent possible, provide products of the same kind from a single source.
 - 1. When specified products are available only from sources that do not, or cannot, produce a quantity adequate to complete project requirements in a timely manner, consult with the Architect to determine the most important product qualities before proceeding. Qualities may include attributes, such as visual appearance, strength, durability or compatibility. When a determination has been made select products from sources producing products that possess these qualities to the fullest extent possible.
- B. Compatibility of Options: When the Contractor is given the option of selecting between two (2) or more products for use on the project, the product selected shall be compatible with products previously selected, even if previously selected products were also options.
 - 1. Each Prime Contractor is responsible for providing products and construction methods that are compatible with products and construction methods of other prime or separate contactors.
 - 2. If a dispute arises between Prime Contractors over concurrently selectable, but incompatible products, the Architect will determine which products shall be retained and which are incompatible and must be replaced.
- C. Foreign Product Limitations: Except under one or more of the following conditions, provide domestic products, not foreign products, for inclusion in the work:
 - 1. No available domestic product complies with the contract documents.
 - 2. Domestic products that comply with the contract documents are available only at prices or terms substantially higher than foreign products that comply with the contract documents.
- D. Nameplates: Except for required labels and operating data, do not attach or imprint manufacturers or producer's nameplate or trademarks on exposed surfaces of products that will be exposed to view in occupied spaces or on the exterior.
 - 1. Labels: Locate required product labels and stamps on concealed surfaces, or where required for observation after installation, on accessible surfaces that are not conspicuous.
 - 2. Equipment Nameplates: Provide a permanent nameplate on each item of service connected or power operated equipment. Locate on an easily accessible

SECTION 01600 – MATERIALS AND EQUIPMENT

surface that is inconspicuous in occupied spaces. The nameplate shall contain the following information and other essential operating data:

- a. Name of Product and Manufacturer
- b. Model and Serial Number
- c. Capacity
- d. Speed
- e. Ratings

1.6 PRODUCT DELIVERY, STORAGE AND HANDLING

A. Deliver, store and handle products according to the Manufacturer's recommendations, using means and methods that will prevent damage, deterioration and loss, including theft.

1. Schedule delivery to minimize long term storage at the site and to prevent overcrowding of construction spaces.
2. Coordinate delivery with installation time to assure minimum holding time for items that are flammable, hazardous, easily damaged or sensitive to deterioration, theft and other losses.
3. Deliver products to the site in an undamaged condition in the manufacturer's original sealed container or other packaging system, complete with labels and instructions for handling, storing, unpacking, protecting and installing.
4. Inspect products upon delivery to ensure compliance with the contract documents and to ensure that products are undamaged and properly protected.
5. Store products at the site in a manner that will facilitate inspection and measurement of quantity or counting of units.
6. Store heavy materials away from the project structure in a manner that will not endanger the supporting construction.
7. Store products subject to damage by the elements above ground, under cover in a weather tight enclosure, with ventilation adequate to prevent condensation. Maintain temperature and humidity within range required by manufacturer's instructions.

PART 2 – PRODUCTS

2.1 PRODUCT SELECTION

SECTION 01600 – MATERIALS AND EQUIPMENT

- A. General Product Requirements: Provide products that comply with the contract documents that are undamaged and, unless otherwise indicated, new at the time of installation.
1. Provide products complete with accessories, trim, finish, safety guards, and other devices and details needed for a complete installation and the intended use and effect.
 2. Standard Products: Where available, provide standard products of types that have been produced and used successfully in similar situations on other projects.
- B. Product Selection Procedures: The contract documents and governing regulations govern product selection. Procedures governing product selection include the following:
1. Proprietary Specification Requirements: Where specifications name only a single product or manufacturer, provide the product indicated. No substitutions will be permitted.
 2. Semi Proprietary Specification Requirements: Where specifications name two (2) or more products or manufacturers, provide one (1) of the products indicated. No substitutions will be permitted.
 - a. Where specifications specify products or manufactures by name, accompanied by the term “or equal” or “or approved equal.” Comply with the contract document provisions concerning *Substitutions* to obtain approval for use of an unnamed product.
 3. Non-Proprietary Specifications: When specifications list products or manufacturers that are available and may be incorporated in the work, but do not restrict the Contractor to use of these products only, the Contractor may propose any available product that complies with contract requirements. Comply with contract document provisions concerning *Substitutions* to obtain approval for use of an unnamed product.
 4. Descriptive Specification Requirements: Where specifications describe a product or assembly, listing exact characteristics required, with or without use of a brand or trade name, provide a product or assembly that provides the characteristics and otherwise complies with contract requirements.
 5. Performance Specification Requirements: Where specifications require compliance with performance requirements, provide products that comply with these requirements and are recommended by the manufacturer for the application indicated.

SECTION 01600 – MATERIALS AND EQUIPMENT

- a. Manufacturer's recommendations may be contained in published product literature or by the Manufacturer's Certification of Performance.
6. Compliance with Standards, Codes, and Regulations: Where specifications only require compliance with an imposed code, standard or regulation, select a product that complies with the standards, codes or regulations specified.
7. Visual Matching: Where specifications require matching an established sample, the Architect's decision will be final on whether a proposed product matches satisfactorily.
 - a. Where no product available within the specified category matches satisfactorily and complies with other specified requirements, comply with provisions of the contract documents concerning *Substitutions* for selection of a matching product in another product category.
8. Visual Selection: Where specified product requirements include the phrase "...as selected from Manufacturer's standard colors, patterns, textures..." or a similar phrase, select a product and Manufacturer that comply with other specified requirements. The Architect will select the color, pattern and texture from the product line selected.
9. Allowances: Refer to individual specification sections and *Allowance* provisions in Division 1 for allowances that control product selection and for procedures required for processing such selections.

PART 3 – EXECUTION

3.1 INSTALLATION OF PRODUCTS

- A. Comply with Manufacturer's instructions and recommendations for installation of products in the applications indicated. Anchor each product securely in place, accurately located and aligned with other work.
 1. Clean exposed surfaces and protect as necessary to ensure freedom from damage and deterioration at time of Substantial Completion.

END OF SECTION 01600

SECTION 01631 - SUBSTITUTIONS

PART 1 - GENERAL

1.1 RELATED DOCUMENTS

- A. Drawings and general provisions of the Contract, including all bid documents and addendums associated with this project shall apply to this section.

1.2 SUMMARY

- A. This Section includes administrative and procedural requirements for handling requests for substitutions made after award of the Contract.
- B. Related Sections: The following sections contain requirements that relate to this Section:
 - 1. Division 1 SECTION 01420 - REFERENCES specifies the applicability of industry standards to products specified.
 - 2. Division 1 SECTION 01300 - SUBMITTALS specifies requirements for submitting the Contractor's Construction Schedule and the Submittal Schedule.

1.3 DEFINITIONS

- A. Definitions in this article do not change or modify the meaning of other terms used in the contract documents.
- B. Substitutions: Changes in products, materials, equipment, and methods of construction required by the contract documents proposed by the Contractor after award of the Contract are considered to be requests for substitutions. The following are not considered to be requests for substitutions:
 - 1. Substitutions requested during the bidding period, and accepted by addendum prior to award of the Contract, are included in the contract documents and are not subject to requirements specified in this section for substitutions.
 - 2. Revisions to the Contract Documents requested by the Owner or Architect.
 - 3. Specified options of products and construction methods included in the contract documents.
 - 4. The Contractor's determination of and compliance with governing regulations and orders issued by governing authorities.

1.4 SUBMITTALS

SECTION 01631 - SUBSTITUTIONS

- A. Substitution Request Submittal: The Architect will consider requests for substitution if received within sixty (60) days after commencement of the work. Requests received more than sixty (60) days after commencement of the work may be considered or rejected at the discretion of the Architect.
1. Submit three (3) copies of each request for substitution for consideration. Submit requests in the form and according to procedures required for change-order proposals and include the Product Evaluation Questionnaire (CP-F116) found within these bid documents.
 2. Identify the product or the fabrication or installation method to be replaced in each request. Include related specification section and drawing numbers.
 3. Provide complete documentation showing compliance with the requirements for substitutions, and the following information, as appropriate:
 - a. Coordination information, including a list of changes or modifications needed to other parts of the work and to construction performed by the Owner and separate contractors, that will be necessary to accommodate the proposed substitution.
 - b. A detailed comparison of significant qualities of the proposed substitution with those of the work specified. Significant qualities may include elements, such as performance, weight, size, durability, and visual effect.
 - c. Product Data, including drawings and descriptions of products and fabrication and installation procedures.
 - d. Samples, where applicable or requested.
 - e. A statement indicating the substitution's effect on the Contractor's Construction Schedule compared to the schedule without approval of the substitution. Indicate the effect of the proposed substitution on overall Contract Time.
 - f. Cost information, including a proposal of the net change, if any in the Contract Sum.
 - g. The Contractor's certification that the proposed substitution conforms to requirements in the Contract Documents in every respect and is appropriate for the applications indicated.
 - h. The Contractor's waiver of rights to additional payment or time that may subsequently become necessary because of the failure of the substitution to perform adequately.

SECTION 01631 - SUBSTITUTIONS

4. Architect's Action: If necessary, the Architect will request additional information or documentation for evaluation within one (1) week of receipt of a request for substitution. The Architect will notify the Contractor of acceptance or rejection of the substitution within three (3) weeks of receipt of the request, or two (2) weeks of receipt of additional information or documentation, whichever is later. Acceptance will be in the form of a change order.
 - a. Use the product specified if the Architect cannot make a decision on the use of a proposed substitute within the time allocated.

PART 2 - PRODUCTS

2.1 SUBSTITUTIONS

- A. Conditions: The Architect will receive and consider the Contractor's request for substitution when one or more of the following conditions are satisfied, as determined by the Architect. If the following conditions are not satisfied, the Architect will return the requests without action except to record noncompliance with these requirements.
 1. Extensive revisions to the contract documents are not required.
 2. Proposed changes are in keeping with the general intent of the contract documents.
 3. The request is timely, fully documented, and properly submitted.
 4. The specified product or method of construction cannot be provided within the Contract Time. The Architect will not consider the request if the product or method cannot be provided as a result of failure to pursue the work promptly or coordinate activities properly.
 5. The request is directly related to an "or-equal" clause or similar language in the contract documents.
 6. The requested substitution offers the Owner a substantial advantage, in cost, time, energy conservation, or other considerations, after deducting additional responsibilities the Owner must assume. The Owner's additional responsibilities may include compensation to the Architect for redesign and evaluation services, increased cost of other construction by the Owner, and similar considerations.
 7. The specified product or method of construction cannot receive necessary approval by a governing authority, and the requested substitution can be approved.

SECTION 01631 - SUBSTITUTIONS

8. The specified product or method of construction cannot be provided in a manner that is compatible with other materials and where the Contractor certifies that the substitution will overcome the incompatibility.
 9. The specified product or method of construction cannot be coordinated with other materials and where the Contractor certifies that the proposed substitution can be coordinated.
 10. The specified product or method of construction cannot provide a warranty required by the contract documents and where the Contractor certifies that the proposed substitution provides the required warranty.
- B. The Contractor's submittal and the Architect's acceptance of shop drawings, product data, or samples for construction activities not complying with the contract documents do not constitute an acceptable or valid request for substitution, nor do they constitute approval.

PART 3 - EXECUTION (Not Applicable)

END OF SECTION 01631

SECTION 01631 - SUBSTITUTIONS

PRODUCT EVALUATION QUESTIONNAIRE

When proposing to substitute products for those specified or proposing a product to meet a specified performance standard, please furnish the following information to assist the Owner and Architect in evaluating the proposed product.

Bid/Quote #: _____

Project: _____

Specification Section: _____

Division: _____

Article #: _____

Name of Product: _____

Manufacturer's Name and Address: _____

1. Attach manufacturer's complete technical data and all information relating to limitations of the product information requiring further testing be deemed necessary by the Architect, the cost of the prescribed test shall be borne by the Contractor. Contractor shall send product samples upon request.
2. Attach a list of projects where comparable use has been made of this product. List the name and location of the project, name of Owner or Architect, Engineer, General Contractor, and Subcontractor (if applicable), and the year installed.
3. List any problems encountered with this product on projects where it has been used. What corrective measures were required?
4. Provide a detailed comparison of the proposed substitute product with that of the specified product. Differences are to be highlighted and called out.
5. Submit a detailed specification, conforming to the format of the technical specifications herein contained, tailored to this project for installation of this product.
6. Will the services of an expert field representative be furnished to supervise the installation of this product?

SECTION 01631 - SUBSTITUTIONS

- 7. Describe maintenance requirements for this product and availability of expert repair service, if needed.
- 8. Will the proposed substitution result in a change in Contract price or time of completion? If so, submit itemization of price change and explain effect on time of completion.
- 9. Will the use of the proposed product necessitate a change in the contract drawings or specifications?
- 10. Will the use of this product necessitate the payment of any license fees or royalties?
- 11. Furnish information establishing financial responsibility of the manufacturer. (Number of years in business, volume of business, Dunn & Bradstreet rating, etc.)
- 12. The Contractor certifies that he or she understands the conditions of use to which this product will be put and he/she warrants this product as stipulated in the General Conditions.

Name of Contractor

Signature of Officer, Owner or Partner

Date

SECTION 01700 - CONTRACT CLOSEOUT

PART 1 - GENERAL

1.1 RELATED DOCUMENTS

- A. Drawings and general provisions of the Contract, including all bid documents and addendums associated with this project shall apply to this section.

1.2 SUMMARY

- A. This section includes administrative and procedural requirements for Contract closeout including, but not limited to, the following:

1. Inspection Procedures
2. Submittal of Project Record Document
3. Submittal of Operation and Maintenance Manual
4. Submittal of Warranties
5. Final Cleaning
6. Submittal of Regulated Systems [ACBM (Asbestos Containing Building Materials) & Lead] Closeout Documents
7. Submittal of any Final Prevailing Wage Reports

- B. Closeout requirements for specific construction activities are included in the appropriate sections in Divisions 2 through 16.

1.3 SUBSTANTIAL COMPLETION

- A. Preliminary Procedures: Before requesting inspection for certification of Substantial Completion, complete the following. List exceptions in the request.

1. In the Application for Payment that coincides with, or first follows, the date Substantial Completion is claimed, show one hundred percent (100%) completion for the portion of the work claimed as substantially complete.
 - a. Include supporting documentation for completion as indicated in these Contract Documents and a statement showing an accounting of changes to the contract sum.
 - b. If one hundred percent (100%) completion cannot be shown, include a list of incomplete items, the value of incomplete construction, and reasons the work is not complete.

SECTION 01700 - CONTRACT CLOSEOUT

- c. Provide a list of all warranties, provide warranty duration, complete contract information of firm, and name of individual who will be performing work – post one (1) year. extended warranties will be submitted on a separate spread sheet within the closeout documents in the following format. Specification #, Company responsible for performing the warranty work, Local contact for responsible individual, phone number and email address, warranty description, warranty period, warranty start and end dates.
2. Advise the Owner of pending insurance changeover requirements.
3. Submit specific warranties, workmanship bonds, maintenance agreements, final certifications, and similar documents.
4. Obtain and submit releases enabling the Owner unrestricted use of the work and access to services and utilities.
5. Include occupancy permits, operating certificates, and similar releases.
6. Submit record drawings, maintenance manuals, final project photographs, damage or settlement surveys, property surveys, and similar final record information.
7. Submit all required training meeting minutes and video recordings of all training courses.
8. Deliver tools, spare parts, extra stock, and similar items.
9. Make final changeover of permanent locks and transmit keys to the Owner. Advise the Owner's personnel of changeover in security provisions.
10. Complete startup testing of systems and videoed training instruction of/for the Owner's Operation and Maintenance personnel.
11. Discontinue and remove temporary facilities from the site, along with mockups, construction tools, and similar elements.
12. Complete final clean-up requirements, including touch up painting.
13. Touch-up and otherwise repair and restore marred, exposed finishes.
14. Provide Contractor furnished fixtures, furnishings, and equipment individually valued over \$5,000 including description, manufacturer model and serial number, location at site, and specific value for equipment.

SECTION 01700 - CONTRACT CLOSEOUT

B. Inspection Procedures: On receipt of a request for inspection, the Architect will either proceed with inspection or advise the Contractor of unfilled requirements. The Architect will prepare the Certificate of Substantial Completion following inspection or advise the Contractor of construction that must be completed or corrected before the certificate will be issued.

1. The Architect will repeat inspection when requested and assured that the work is substantially complete.
2. Results of the completed inspection will form the basis of requirements for final acceptance.
3. The cost for any Architectural services for reinspection is the Contractor's sole responsibility.

1.4 FINAL ACCEPTANCE

A. Preliminary Procedures: Before requesting final inspection for certification of final acceptance and final payment, complete the following. List exceptions in the request.

1. Submit the final payment request with releases and supporting documentation not previously submitted and accepted. Include insurance certificates for products and completed operations where required.
2. Submit an updated final statement, accounting for final additional changes to the Contract Sum.
3. Submit a certified copy of the WCSD's, Architect's & Engineer's final inspection lists of items to be completed or corrected, endorsed, and dated by the Architect. The certified copy of the list shall state that each item has been completed or otherwise resolved for acceptance and shall be endorsed and dated by the Architect.
4. Submit consent of surety to final payment.
5. Submit a final liquidated damages settlement statement.
6. Submit evidence of final, continuing insurance coverage complying with insurance requirements.
7. Submit final meter readings for utilities, a measured record of stored fuel, and similar data as of the date of Substantial Completion or when the Owner took possession of and assumed responsibility for corresponding elements of the work.

SECTION 01700 - CONTRACT CLOSEOUT

- B. Reinspection Procedure: The Architect will reinspect the work upon receipt of notice that the work, including inspection list items from earlier inspections, has been completed, except for items whose completion is delayed under circumstances acceptable to the Architect.
1. Upon completion of reinspection, the Architect will prepare a Certificate of Final Acceptance. If the work is incomplete, the Architect will advise the Contractor of work that is incomplete or of obligations that have not been fulfilled but are required for final acceptance.
 2. If necessary, reinspection will be repeated.

1.5 RECORD DOCUMENT SUBMITTALS

- A. General: Do not use record documents for construction purposes. Protect record documents from deterioration and loss in a secure, fire-resistant location. Provide access to record documents for the Architect's reference during normal working hours.
- B. Record Drawings: Maintain a clean, undamaged set black line white prints of Contract Drawings and Shop Drawings or continuous live electronic as built drawings with appropriate mark ups. Mark the set to show the actual installation where the installation varies from the work as originally shown. Mark which drawing is most capable of showing conditions fully and accurately. Where Shop Drawings are used, record a cross reference at the corresponding location on the Contract Drawings. Give particular attention to concealed elements that would be difficult to measure and record at a later date. At the conclusion of the project, this record set of prints shall be submitted to the Architect for his/her review and comment. If the record set of prints is found to be complete and accurate, the prints shall be returned to the Contractor for submittal to the Owner with other closeout documents.

Record drawings must be reviewed and approved prior to each pay request by the Owner's representative. The drawings should reflect the work that has been accomplished during the time period of the pay request. Lack of record drawings approval at the time of submittal of a pay request will result in a potential delay in the processing of the pay request.

1. Mark record sets with red erasable pencil or electronic. Use other colors to distinguish between variations in separate categories of work.
2. Mark new information that is important to the Owner but was not shown on Contract Drawings or Shop Drawings.
3. Note related change order numbers where applicable.
4. Organize record drawing sheets into manageable sets.

SECTION 01700 - CONTRACT CLOSEOUT

5. Provide one Bound set of record drawings with durable paper cover sheets; print suitable titles, dates and other identification on the cover of each set.
 6. Provide record drawings using electronic media, including one PDF and one Auto Cad compatible. Original media will be provided for Contractor to make required record drawing notations.
- C. Record Specifications: Maintain one complete copy of the Project Manual, including addenda. Include with the Project Manual, one copy of other written construction documents, such as Change Orders and modifications issued in printed form during construction.

Record specifications must be reviewed and approved prior to each pay request by the Owner's representative. The specifications should reflect the work that has been accomplished during the time period of the pay request. Lack of record specification approval at the time of submittal of a pay request will result in a potential delay in the processing of the pay request.

1. Mark these documents to show substantial variations in actual work performed in comparison with the text of the specifications and modifications.
 2. Give particular attention to substitutions and selection of options and information on concealed construction that cannot otherwise be readily discerned later by direct observation.
 3. Note related record drawing information and product data.
 4. Upon completion of the work, submit an electronic record specifications to the Architect for the Owner's records.
- D. Record Product Data: Maintain one (1) copy of each Product Data submittal. Note related Change Orders and markup of record drawings and specifications.
1. Mark these documents to show significant variations in actual work performed in comparison with information submitted. Include variations in products delivered to the site and from the manufacturer's installation instructions and recommendations.
 2. Give particular attention to concealed products and portions of the work that cannot otherwise be readily discerned later by direct observation.
 3. Upon completion of markup, submit complete set of record Product Data to the Architect for the Owner's records.

SECTION 01700 - CONTRACT CLOSEOUT

- E. Record Sample Submitted: Immediately prior to Substantial Completion, the Contractor shall meet with the Architect and the Owner's personnel at the project site to determine which samples are to be transmitted to the Owner for record purposes. Comply with the Owner's instructions regarding delivery to the Owner's sample storage area.
- F. Miscellaneous Record Submittals: Refer to other specification sections for requirements of miscellaneous record keeping and submittals in connection with actual performance of the work. Immediately prior to the date or dates of Substantial Completion, complete miscellaneous records and place in good order. Identify miscellaneous records properly and bind or electronic file, ready for continued use and reference. Submit to the Architect for the Owner's records.
- G. Maintenance Manuals: Organize operation and maintenance data into suitable sets of manageable size. Bind 2 copies (1 hard copy / 1 electronic) properly indexed data in individual, heavy duty, 2-inch, 3-ring, vinyl covered binders, with pocket folders for folded sheet information. Mark appropriate identification on front and spine of each binder. Include the following types of information:
1. Emergency instructions
 2. Spare parts list
 3. Copies of warranties
 4. Wiring diagrams
 5. Recommended turn around cycles
 6. Inspection procedures
 7. Shop Drawings and Product Data
 8. Fixture lamping schedule
 9. Any other applicable information
- H. Warranty Manuals: organize warranty data into suitable set of manageable size, Bind 1 copy and 1 electronic properly indexed in individual, heavy duty 3 ring binder. Mark appropriate identification on front and spine. Include the following types of information:
1. All products with extended warranties beyond 1 year, including duration (start and end date, similar to what is described in 1.3, A, 1,c)
 2. Manufacturer

SECTION 01700 - CONTRACT CLOSEOUT

3. Model / Serial where applicable
4. Manufacturer contact information
- I. Provide one complete download of all Procore Files properly organized and linked in PDF versions. Contractor to ensure original Procore file and documentation remains in place on Procore for use by owner. Owner shall instruct the contractor of the proper file structure

PART 2 - PRODUCTS (Not Applicable)

PART 3 - EXECUTION

3.1 CLOSEOUT PROCEDURES

- A. Operation and Maintenance Instructions: Arrange for each installer of equipment that requires regular maintenance to meet with the Owner's personnel to provide instruction in proper operation and maintenance. Film Document each training and demonstration. Provide instruction by manufacturer's representatives if installers are not experienced in operation and maintenance procedures. Include a detailed review of the following items:
 1. Maintenance manuals
 2. Record documents
 3. Spare parts and materials
 4. Tools
 5. Lubricants
 6. Fuels
 7. Identification systems
 8. Control sequences
 9. Hazards
 10. Cleaning
 11. Warranties and bonds
 12. Maintenance agreements and similar continuing commitments

SECTION 01700 - CONTRACT CLOSEOUT

B. As part of instruction for operating equipment, demonstrate the following procedures:

1. Start-up
2. Shut down
3. Emergency operations
4. Noise and vibration adjustments
5. Safety procedures
6. Economy and efficiency adjustments
7. Effective energy utilization

END OF SECTION 01700

SECTION 01710 - FINAL CLEANING

PART 1 - GENERAL

1.1 RELATED DOCUMENTS

- A. Drawings and general provisions of the Contract, including all contract documents and addendums associated with this project shall apply to this section.

1.2 SUMMARY

- A. This section includes administrative and procedural requirements for final cleaning at Substantial Completion.
- B. Related Sections: The following sections contain requirements that relate to this Section:
 - 1. Division 1 SECTION 01500 – CONSTRUCTION FACILITIES AND TEMPORARY CONTROLS specifies general cleanup and waste removal requirements.
 - 2. Division 1 SECTION 1700 – CONTRACT CLOSEOUT specifies general contract closeout requirements.
 - 3. Special cleaning requirements for specific construction elements are included in appropriate sections of Divisions 2 through 16.
- C. Multiple Prime Contracts: Each Prime Contractor is responsible for final cleaning their own work. The Contractor for General Construction is responsible for coordinating final cleaning of an area or piece of equipment where more than one (1) Prime Contractor is involved.
- D. Environmental Requirements: Conduct cleaning and waste disposal operations in compliance with local laws and ordinances. Comply fully with federal and local environmental and antipollution regulations.
 - 1. Do not dispose of volatile wastes, such as mineral spirits, oil, or paint thinner, in storm or sanitary drains.
 - 2. Burning or burying of debris, rubbish, or other waste material on the premises is not permitted.

PART 2 - PRODUCTS

2.1 MATERIALS

- A. Cleaning Agents: Use cleaning materials and agents recommended by the manufacturer or fabricator of the surface to be cleaned. Do not use cleaning agents

SECTION 01710 - FINAL CLEANING

that are potentially hazardous to health or property or that might damage finished surfaces.

PART 3 - EXECUTION

3.1 FINAL CLEANING

- A. General: Provide final-cleaning operations to all work spaces and any adjacent spaces affected by the work performed. Employ experienced workers or professional cleaners for final cleaning. Clean each surface or unit of Work to the condition expected from a commercial building cleaning and maintenance program. Comply with manufacturer's instructions.
- B. Complete the following cleaning operations before requesting inspection for certification of Substantial Completion for the entire Project or a portion of the Project.
 - 1. Clean the Project Site, yard and grounds, in areas disturbed by construction activities, including landscape development areas, of rubbish, waste material, litter, and foreign substances.
 - 2. Sweep paved areas broom clean. Rake grounds that are neither planted nor paved to a smooth, even-textured surface.
 - 3. Remove petrochemical spills, stains, and other foreign deposits.
 - 4. Remove tools, construction equipment, machinery, and surplus material from the site.
 - 5. Remove snow and ice to provide safe access to the building.
 - 6. Clean exposed exterior and interior hard surfaced finishes to a dirt free condition, free of stains, films, and similar foreign substances. Avoid disturbing natural weathering of exterior surfaces. Restore reflective surfaces to their original condition. Wax any required flooring to the District standard.
 - 7. Remove debris and surface dust from limited access spaces, including roofs, plenums, shafts, trenches, equipment vaults, manholes, attics, and similar spaces.
 - 8. Broom clean concrete floors in unoccupied spaces.
 - 9. Vacuum clean carpet and similar soft surfaces, removing debris and excess nap. Shampoo, if required.

SECTION 01710 - FINAL CLEANING

10. Clean transparent materials, including mirrors and glass in doors and windows. Remove glazing compounds and other substances that are noticeable vision-obscuring materials. Replace chipped or broken glass and other damaged transparent materials. Polish mirrors and glass, taking care not to scratch surfaces.
 11. Remove labels that are not permanent labels.
 12. Touch up and otherwise repair and restore marred, exposed finishes and surfaces. Replace finishes and surfaces that cannot be satisfactorily repaired or restored or that already show evidence of repair or restoration.
 - a. Do not paint over "UL" and similar labels, including mechanical and electrical nameplates.
 13. Wipe surfaces of mechanical and electrical equipment, elevator equipment, and similar equipment. Remove excess lubrication, paint and mortar droppings, and other foreign substances.
 14. Clean plumbing fixtures to a sanitary condition, free of stains, including stains resulting from water exposure.
 15. Replace disposable air filters and clean permanent air filters. Clean exposed surfaces of diffusers, registers, and grills.
 16. Clean ducts, blowers, and coils if units were operated without filters during construction.
 17. Clean food-service equipment to a sanitary condition, ready and acceptable for its intended use.
 18. Clean light fixtures, lamps, globes, and reflectors to function with full efficiency. Replace burned-out bulbs and defective and noisy starters in fluorescent and mercury vapor fixtures.
 19. Leave the Project clean and ready for occupancy.
- C. Pest Control: Engage an experienced, licensed exterminator to make a final inspection and rid the Project of rodents, insects, and other pests. Comply with regulations of local authorities. This section is only applicable for a new facility or an addition to an existing facility.
- D. Removal of Protection: Remove temporary protection and facilities installed during construction to protect previously completed installations during the remainder of the construction period.

SECTION 01710 - FINAL CLEANING

- E. Compliances: Comply with regulations of Authorities Having Jurisdiction and safety standards for cleaning. Do not burn waste materials. Do not bury debris or excess materials on the Owner's property. Do not discharge volatile, harmful, or dangerous materials into drainage systems. Remove waste materials from the site and dispose of lawfully.
- 1. Where extra materials of value remain after completion of associated Work, they become the Owner's property. Dispose of these materials as directed by the Owner.

END OF SECTION 01710



895 Roberta Lane, Suite 104, Sparks, NV 89431
(775) 359-3303 Fax (775) 359-3329

dyssey ENGINEERING
INCORPORATED

March 31, 2025

Caitlin Davis
Design Project Manager II
WCSD Capital Projects Department
14101 Old Virginia Road
Reno, NV 89521-8912

**RE: 25-151-130-01 – Roy Gomm Elementary School Drainage Channel Addition
Engineer’s Scope of Work Narrative**

Caitlin,

Below is a brief narrative for the scope of work to be completed with this project.

Demolition

The work comprising this item shall include all labor, equipment, materials, and incidentals necessary for this portion of the project to be completed to the satisfaction of WCSD personnel. This item shall include: sawcutting of sidewalk, removal of wooden planter bed and arch structure, removal of portion of existing chainlink fence, removal of tetherball poles, removal of concrete picnic table pads, and removal of all debris created.

Grading

The work comprising this item shall include all labor, equipment, materials, and incidentals necessary for this portion of the project to be completed to the satisfaction of WCSD personnel. This item shall include: grading and preparation of the site for the proposed curb & channel, rip-rap swale, rip-rap reinforced slopes, decomposed granite area, picnic table pads, curb, and valley gutter.

Decomposed Granite

The work comprising this item shall include all labor, equipment, materials, and incidentals necessary for this portion of the project to be completed to the satisfaction of WCSD personnel. This item shall include: placement and compaction of decomposed granite to the depth and compaction level noted in plans.

Type 2 Class B Aggregate Base

The work comprising this item shall include all labor, equipment, materials, and incidentals necessary for this portion of the project to be completed to the satisfaction of WCSD personnel. This item shall include placement and compaction of type 2 class B aggregate base to the depth and compaction level noted in plans for: curb & channel, curb, picnic table pads, and valley gutter

Class 150 Rip-Rap

The work comprising this item shall include all labor, equipment, materials, and incidentals necessary for this portion of the project to be completed to the satisfaction of WCSD personnel. This item shall include placement of class 150 rip-rap to the depth noted in plans utopfor: rip-rap lined swale, 3:1 slope areas around curb, 3:1 slope areas around curb & channel, and landscape areas requested by WCSD.

Longitudinal Valley Gutter

The work comprising this item shall include all labor, equipment, materials, and incidentals necessary for this portion of the project to be completed to the satisfaction of WCSD personnel. This item shall include: construction of longitudinal valley gutter on furnished and compacted aggregate base and modification of existing valley gutter at point of connection.

P.C.C. Curb

The work comprising this item shall include all labor, equipment, materials, and incidentals necessary for this portion of the project to be completed to the satisfaction of WCSD personnel. This item shall include: construction of P.C.C. curb on furnished and compacted aggregate base and modification of play area wall for construction to be returned to existing dimensions after construction has concluded.

P.C.C. Curb & Channel

The work comprising this item shall include all labor, equipment, materials, and incidentals necessary for this portion of the project to be completed to the satisfaction of WCSD personnel. This item shall include: construction of P.C.C. curb and channel on furnished and compacted aggregate base.

Chainlink Fence

The work comprising this item shall include all labor, equipment, materials, and incidentals necessary for this portion of the project to be completed to the satisfaction of WCSD personnel. This item shall include: construction of chainlink fence, footings, supports, and connection to existing fence to form one continuous barrier free from gaps or holes.

P.C.C. Picnic Table Pad

The work comprising this item shall include all labor, equipment, materials, and incidentals necessary for this portion of the project to be completed to the satisfaction of WCSD personnel. This item shall include: construction of concrete pad on furnished and compacted aggregate base and bolting down of reused picnic tables to newly constructed pads.

As Needed Tree Removal

The work comprising this item shall include all labor, equipment, materials, and incidentals necessary for this portion of the project to be completed to the satisfaction of WCSD personnel. This item shall include: evaluation of which trees on site will hamper or pose risks to crews during construction, aesthetic and shade bearing value of a given tree, feasibility of tree protection during construction, and survivability of trees in their current location after construction has been completed. For trees deemed necessary to remove, in addition to disposal of the tree the stumps must be ground down, chips removed and replaced with fill and decomposed granite.

Metal Planter Relocation

The work comprising this item shall include all labor, equipment, materials, and incidentals necessary for this portion of the project to be completed to the satisfaction of WCSD personnel. This item shall include: emptying metal planters of existing soil, moving metal planters to their new location shown on plans, refilling metal planters completely with soil suitable for future planting.

24" Sidewalk Crossdrain

The work comprising this item shall include all labor, equipment, materials, and incidentals necessary for this portion of the project to be completed to the satisfaction of WCSD personnel. This item shall include: construction of sidewalk crossdrain to match detail provided on plans.

Clean On-Site Storm Drain System

The work comprising this item shall include all labor, equipment, materials, and incidentals necessary for this portion of the project to be completed to the satisfaction of WCSD personnel. This item shall include: cleaning of all storm drain inlets, pipes, and conveyance infrastructure to a functional state. This includes all facilities on the premises and not shown on plan set. Contact WCSD personnel for further guidance.

Erosion Control

The work comprising this item shall include all labor, equipment, materials, and incidentals necessary for this portion of the project to be completed to the satisfaction of WCSD personnel. This item shall include: cleaning and mitigations efforts necessary to prevent runoff and wind transfer of material off site during demolition and construction. Reference SWPPP for best practices.

Temporary Fencing

The work comprising this item shall include all labor, equipment, materials, and incidentals necessary for this portion of the project to be completed to the satisfaction of WCSD personnel. This item shall include: construction and maintenance of temporary fencing to protect site and prevent unauthorized access.

Please contact us if you have any questions or require additional materials.

Sincerely,
Odyssey Engineering



Alec Morgan, E.I.

WASHOE COUNTY SCHOOL DISTRICT
MATERIAL, WATER, AND LEAD DISTURBANCE PERMIT

FACILITY AND MATERIAL LOCATION: Gomm ES

MDP #25-091

DESCRIPTION OF WORK TO BE PERFORMED: Site Drainage Improvements

IT IS THE RESPONSIBILITY OF THE CONTRACTOR/WORKER TO IDENTIFY MATERIAL TYPE PRIOR TO DISTURBANCE. ONLY MATERIALS LISTED ON THIS PERMIT MAY BE DISTURBED. ANY NEW MATERIAL DISCOVERED OR ANY MATERIAL WHOSE EXACT NATURE OR CHARACTER IS UNCERTAIN REQUIRES A NEW PERMIT PRIOR TO DISTURBANCE. ANY CITATIONS OR ASBESTOS/LEAD CONTAMINATION RESULTING FROM THE IMPROPER OR UNAUTHORIZED DISTURBANCE OF ASBESTOS OR LEAD MATERIALS IS SOLELY THE RESPONSIBILITY OF THE CONTRACTOR. A COPY OF THIS PERMIT MUST BE SIGNED BY THE CONTRACTOR AND SUBMITTED TO THE DISTRICT PRIOR TO STARTING THE PROJECT.

ALL ITEMS	MATERIAL DESCRIPTION: SEE FACS REPORT
AHERA MATERIAL NUMBER: N/A	CONTAINS ASBESTOS ?: SEE FACS REPORT
MATERIAL DISTURBANCE INSTRUCTIONS: MATERIAL DISTURBANCE INSTRUCTIONS: THE PLANNING DEPARTMENT USED AN OUTSIDE CONSULTING COMPANY (FACS) TO CREATE AN ASBESTOS AND LEAD ASSESSMENT FOR THIS PROJECT. FOR LEAD AND ASBESTOS INFORMATION REFER TO THE FACS REPORT DATED 3/24/25.	
ANY QUESTIONS RELATED TO ASBESTOS AND LEAD CONTENT, OR DISTURBANCE REQUIREMENTS SHOULD BE ADDRESSED TO THE PLANNING DEPARTMENT, PROJECT MANAGER, OR FACS.	

NOTE: THE ASBESTOS MATERIAL DISTURBANCE INSTRUCTIONS LISTED ABOVE ARE BASED ON THE AHERA REGULATION. THERE MAY EXIST OTHER REGULATIONS THAT MAY BE MORE STRINGENT THEN THESE RECOMMENDATIONS. IT IS THE RESPONSIBILITY OF THE CONTRACTOR TO ENSURE COMPLIANCE WITH ALL REGULATIONS THAT ARE APPLICABLE TO THE DISTURBANCE OF ASBESTOS/LEAD CONTAINING MATERIALS. ASBESTOS IS A MICROSCOPIC FIBER AND THE CLEANING OF ASBESTOS DEBRIS MUST BE CONDUCTED TO A MICROSCOPIC LEVEL. IN THE EVENT THAT ANY VISIBLE DEBRIS IS DISCOVERED FROM A DISTURBANCE OR AIR SAMPLING RESULTS ARE NOT PROVIDED TO THE DISTRICT, THE DISTRICT WILL IMMEDIATELY HIRE A THIRD PARTY LEAD/ASBESTOS CONSULTANT TO INVESTIGATE POSSIBLE LEAD/ASBESTOS CONTAMINATION AND AN LEAD/ASBESTOS ABATEMENT CONTRACTOR TO PERFORM ANY RECOMMENDED CLEAN-UP. THE CONTRACTOR WILL BE REQUIRED TO REIMBURSE THE DISTRICT FOR ALL COSTS INCURRED. IF AIR MONITORING IS REQUIRED, AIR MONITORING MUST BE CONDUCTED THROUGHOUT THE PROJECT. AIR MONITORING RESULTS FAXED DIRECTLY FROM THE LAB TO THE ES&A DEPARTMENT @ 851-5695, WITHIN 48 HOURS OF THE DISTURBANCE

DATE ISSUED: March 27, 2025

WASHOE COUNTY SCHOOL DISTRICT MATERIAL, WATER, AND LEAD DISTURBANCE PERMIT CONTINUATION PAGE

Material Water & Lead Disturbance Permit, Water System Disturbance Permit Appendix Page #1

Contractors, their sub-contractors or workers are responsible in completing all work without impacting the water quality of District facilities and the domestic water supplies which feed district facilities. This Water System Disturbance Permit identifies the minimum requirements that Contractors, their sub-contractors and all workers will utilize to perform disturbance to the Districts water systems.

The following general requirements shall apply to any person who will be disturbing a District water system. In addition, they must contact the Environmental, Safety and Assessment Department (ES&A Dept) prior to any disturbance at 325-8494. This phone number has an answering machine and can be accessed 24 hours a day. These disturbances will be logged in and documented by the ES&A department.

All requirements for isolation are designed to protect the facility's potable water source from existing as well as potential cross-connections and to prevent any backflow occurrences in the form of backpressure or backsiphonage. The Water Disturbance Procedures listed are not site or incident specific and great care must be taken by technicians during all valving and isolation activities within a facility to prevent a potential backflow occurrence. There may be additional requirements that must be utilized to prevent any cross-connection or backflow occurrence, and each entity performing the disturbance is responsible for ensuring none occur and utilizing any additional steps as necessary to ensure none result from the completion of this project.

Any costs to correct any cross-connections and/or any backflow occurrences that result from the performance of this project are solely the responsibility of the Contractor, their sub-contractor and workers and the signing of this ES&A Department Disturbance Permit on acknowledges and agrees to this requirement.

FACILITY ISOLATION MINIMUM REQUIREMENTS

MECHANICAL ROOMS:

When turning off or disrupting the water service to a mechanical room all applicable requirements below must be conducted per this permit

1. Remove all hoses from custodial faucets and bibs in location to be effected.
2. Shut down all boiler and chiller circulating pumps. Heating, Cooling and Domestic.
3. Shut down boiler, chiller and cooling tower if present.
4. Isolate boiler, cooling tower, chiller and relieve pressure from boiler.
5. Shut down hot water return pump, isolate any hot water heaters and turn off heating source.
6. Isolate domestic service to mechanical room.
7. Re-establish service to mechanical room in reverse order.

BASIC WING:

When turning off or disrupting the water service to a facility wing all applicable requirements below must be conducted per this permit

1. Remove all hoses from custodial, art and science faucets along with bibs in location to be effected.
2. Isolate all water utilizing chemical dispensers in location to be effected.
3. Shut down and isolate any water using equipment if applicable. Hot water heaters, domestic make ups for heat exchangers, photo labs, etc.
4. Isolate domestic cold water main to wing.
5. Re-establish service to wing in reverse order. Flush system at the end of each lateral to remove any and all foreign material and air.

**WASHOE COUNTY SCHOOL DISTRICT
MATERIAL, WATER, AND LEAD DISTURBANCE PERMIT
CONTINUATION PAGE**

Material Water & Lead Disturbance Permit, Water System Disturbance Permit Appendix Page #2

FACILITY:

When turning off or disrupting the water service to a facility all applicable requirements below must be conducted per this permit. Turning off or disturbing the waters services to a facility should only be done as a last resort. If it is possible to isolate the area of disturbance without disrupting facilities entire water service that is the way the project is to be accomplished. This will also keep the contractor, his sub-contractors or workers from having to perform all the listed requirements.

1. Remove all hoses from custodial, art and science faucets along with bibs in entire facility.
2. Isolate mechanical room. See above requirements.
3. Isolate each individual wing where possible. See above requirements.
4. Isolate all irrigation laterals connected to the domestic potable water supply.
5. Isolate domestic cold water main at all locations present to allow as little drain back as possible.
6. Re-establish service to facility in reverse order. Flush system at the end of each lateral to remove any foreign material and air.

WASHOE COUNTY SCHOOL DISTRICT MATERIAL, WATER, AND LEAD DISTURBANCE PERMIT CONTINUATION PAGE

PAINTS AND COATINGS – Material Disturbance Permit Appendix - Lead in Paints and Coatings in WCSD Facilities

Lead containing paints and coating are present in WCSD facilities. Bidders/Contractors that disturb lead containing or potentially lead containing paints or coatings, by law, are required to know all applicable regulations applicable and comply with all state and federal regulations that apply to the disturbances to lead paints and coating they are conducting. The regulations that requires by a contractor to be properly trained and knowledgeable, related to lead disturbance includes, but is not limited to the following:

- OSHA Regulation CFR 1926.62 – Lead & Appendix A, B, C, & D – Lead Construction Standard.
- OSHA Regulation CFR 1910. 1025 - Lead & Appendix A, B, C, & D – General Industry Standard.
- EPA, 40 CFR Part 745 – Lead; Renovation, Repair, and Painting Regulation.

Bidders/Contractors accept and acknowledge by signing this Material Disturbance Permit, the existence of lead related regulations, and accept all liability related to the disturbance of lead containing materials, citation resulting from, or any other costs the District may incur by the action of all parties of the bidders company or companies hired by the successful bidder to complete this project.

LEAD CATEGORY #N/A	PAINTS, COATINGS & CERAMIC TILE IN BUILDINGS
CONTAINS LEAD?: SEE FACS REPORT	Buildings: ALL
<p><u>Lead Containing or Assumed Lead Containing Paints and Coatings Disturbance Instructions</u> The planning department used FACS to create an asbestos and lead assessment for this project. For lead and asbestos information refer to the FACS report dated 3/24/25.</p> <p><u>OSHA Requirements</u> All persons performing <u>any</u> disturbance to coatings or paints to paints and coating in and on the buildings listed above must have taken an OSHA lead action level training class from a WCSD, ES&A department approved training provider, and utilize lead safe work practices. In addition, all work must be completed, as a minimum, utilizing the lead safe work practices identified in the EPA guidance document titled “steps to lead safe renovation, repair and painting”, pages 12 thru 23. This document is available electronically at the following link: HTTP://WWW.EPA.GOV/LEAD/PUBS/STEPS.PDF.</p> <p><u>EPA Renovation, Repair and Painting Regulation Requirements</u> In general, all firms that disturb 6 square feet of painted surface in a room or 20 square feet on the exterior within a 30 day period in this facility must comply with the EPA’s Renovation, Remodel and Repair (RR&P) regulation and must be registered with the federal EPA. Per the Regulation, the area of disturbance is calculated, by adding up the entire surface areas being removed/disturbed, which then determines the amount of painted surface area disturbed. Work that involves window replacement or demolition of a painted surface, the RR&P regulation applies regardless of size. This regulation also requires that the contractor must assign a RR&P trained supervisor that is responsible for ensuring and documenting all work is conducted in compliance with the RR&P regulation and there are extensive record keeping and notification requirements that the Contractor must perform. In addition, This is a general overview of the regulation and the contractor must refer to regulation for additional requirements and information. Fines are expensive and the compliance with this regulation rests solely on the Contractor so it is very important that Bidders/Contractors are well versed in this regulation.</p>	
<p>– CONTINUED SEE NEXT PAGE #11</p>	

**WASHOE COUNTY SCHOOL DISTRICT
MATERIAL, WATER, AND LEAD DISTURBANCE PERMIT
CONTINUATION PAGE**

LEAD CATEGORY #N/A	PAINTS, COATINGS & CERAMIC TILE IN BUILDINGS CONSTRUCTED BEFORE 1978
CONTAINS LEAD?: SEE FACS REPORT	Buildings: ALL
<p>– CONTINUED FROM PAGE #10</p> <p><u>WCSD Requirements</u></p> <p>In addition to regulatory requirements, the WCSD has requirements that must be met by the Contractor/Bidder. The contractor is responsible for submitting to the ES&A department lead disturbance procedures that outline the lead safe work practices to be utilized and that procedure must comply with the Districts minimum lead disturbance requirements. The current minimum lead disturbance requirements, which will apply to this project, follow these tables.</p> <p>OSHA action level training and RR&P training certification and RR&P firm certification must be submitted to the project manager and they are to submit a copy to the ES&A department. The ES&A department must review, verify, and approve all required documentation prior to the contractor being able to perform any disturbance, so time for review must be taken into account when developing schedules. Once the ES&A department has approved the procedures and training and firm certification, the contractor may proceed but they must notify the ES&A department at 325-8490 of any paint/coating disturbance immediately disturbance prior to the disturbance. ES&A department personnel, project managers and assistant project managers and other district personnel will spot check in the field, to ensure compliance with the contractors submitted and approved procedures.</p> <p>Refer to section listed below regarding lead sampling that may be available.</p>	

WASHOE COUNTY SCHOOL DISTRICT MATERIAL, WATER, AND LEAD DISTURBANCE PERMIT CONTINUATION PAGE

A NOTE ABOUT SAMPLING AND SAMPLING REQUEST PROCEDURES

Only approximately 20% of the paints and coatings in the District have been found to contain lead. The majority of white and off-white paints on sheetrock and block walls does not contain lead in facilities constructed after approx. 1990. Brighter or more colorful paints/coatings on any surface, or all paints and coatings on metals, are much more likely to be found to contain lead in all facilities. In addition, ceramic tile in any age facility is very likely to contain lead. It is highly recommended that sampling be done to confirm lead content unless time does not allow a delay for processing samples through the WCSD ES&A department. If paints and coatings are not sampled, all paints and coatings must be assumed to be lead containing, above 5000 parts per million (lead based), and treated in accordance with all lead regulations, lead specifications, and requirements identified in this permit.

The process to request lead sampling is for anyone requiring sampling to submit through their project's Project Manager. The designated WCSD Project Manager will submit the required sampling forms, and sampling will be coordinated by the ES&A department. A minimum of 10 days will be allowed before sampling results are provided to the Project Manager for them to be distributed to all interested parties. All lead sampling must be processed through the ES&A department, and sampled by ES&A approved and trained lead professionals.

Any paints or coatings that are not specifically addressed on this permit, or on the project drawings, has to be assumed to be lead containing, and above 5000 parts per million (lead based) – no exceptions. Any disturbance to those paints and coatings not specifically addressed on this permit or on the project drawings must be done by properly trained (Minimum of OSHA action level training) personnel, and those disturbances must be performed in accordance with all lead requirements listed in this permit, as well as any applicable regulations and local requirements. Many times scope modifications are required after the bid, and new areas of the facility may need to be disturbed. These areas would not have been addressed on this permit, since they were unknown at the time of issuance. Additional sampling could be conducted by requesting lead sampling through their project's Project Manager, but there will be a delay getting sampling requests and a new MDP would be required. The District reserves the right to direct the Contractor to assume new paints and coatings, due to scope changes, are lead containing and the contractor would then be required to treat all paints and coatings as lead containing in compliance with all requirements of this permit.

REPLACEMENT PAINTS, COATINGS, CERAMIC TILE, AND OTHER LEAD CONTAINING MATERIALS

Unless otherwise specifically allowed by this projects specifications, the Contractor shall not reinstall any lead containing paints/coatings in any detectable levels during the process of completing this project. "lead containing" is defined as any paint or coating that has ANY detectable lead level when paint chip sampling is conducted and chip is analyzed by the ICP method. The District may perform sampling of replacement materials and if analysis finds any detectable levels of lead, the Contractor will be liable for all costs to properly remove that material and re-apply paints and coatings with no detectable levels of lead. Contractors are encouraged to pre-sample paints they may be using to determine the actual amount in paint/coatings used.

WASHOE COUNTY SCHOOL DISTRICT MATERIAL, WATER, AND LEAD DISTURBANCE PERMIT CONTINUATION PAGE

MINIMUM REQUIREMENTS TO PERFORM ATTACHMENTS AND PENETRATIONS IN WCSD FACILITIES

Below are the minimum requirements to perform any Attachment and Penetration activity to a known or assumed asbestos and/or lead containing material in Washoe County School District (WCSD) facilities. This document is not provided to address demolition, stabilization, abatement, or removal activities. If any work to known or assumed asbestos or lead materials need to be done on this project, and it is anything other than the installation of screws, the removal of screws, or the drilling of holes, the successful bidder must comply with, in addition to these minimum requirements, all applicable District asbestos and lead specifications and requirements. Regarding these procedures, the District has done its best to provide a complete and regulatory compliant attachment and penetration procedure, but by signing this MDP, the Contractor acknowledges that it is the successful bidder's sole responsibility for compliance with this MDP, as well as any other applicable regulatory requirements.

ASBESTOS/LEAD PROCEDURE SUBMISSION PROCESS

Prior to starting this project, each contractor working on this project is required to submit to the WCSD ES&A department an asbestos/lead procedure that includes all District requirements listed below. To simplify the procedure submittal process, an electronic PDF fillable template of these requirements will be provided to the successful bidder of this project. This document is available by contacting the assigned WCSD Capital Projects Project Manager for this project. Contractors must utilize the most current above-mentioned electronic template and fill out all required information, add company letterhead, sign, and date the document. The completed procedures will be e-mailed to the Project Manager by all contractors working on this project that will performing any applicable disturbances. Once submitted, the WCSD Project Manager will pass the document onto the ES&A department for approval. Successful bidders are required to add time to their project schedule for this procedure submittal and approval process.

The Contractor has the option to submit a site-specific or blanket district-wide applicable procedure. A district-wide blanket procedure applies to a scheduled project, as well as all future sites where a contractor will be performing disturbances. The site specific procedure will apply to just one site or project. District-wide procedures are valid for one year from the date the procedure is signed by the ES&A department. Site specific procedures will be valid for the term of the project. Each Contractor must receive a signed and approved procedure prior to performing any disturbances to all asbestos/lead paint or assumed asbestos/lead paint materials. The procedure is a combined procedure and it addresses both asbestos and lead disturbances. A minimum of one work day will be required by the ES&A department for the review and approval process.

In addition to the Material Disturbance Permit (MDP), the Contractors must also have a copy of the approved procedures on site at all times. The purpose of this procedure is to document the agreement between the Contractor and the District that all lead and asbestos disturbances performed by staff of the Contractor will be done per all noted District requirements, District Specifications, and project specifications. Again, Contractors must ensure that their procedure has been approved, and the approved signed procedure is on site prior to any disturbance.

MINIMUM REQUIREMENTS

1. Receive approved Lead/Asbestos procedures as identified above.
2. Technicians performing disturbances will be required to have a minimum of AHERA 16 Hour O&M training and OSHA action level training per 29 CFR 1926.62 (i) (2) lead training. In addition, as applicable, contractors must comply with the EPA RR&P training and certifications requirements listed in the RR&P section of this appendix. Copies of training certifications, including a refresher within the last 12 months, will be provided to the ES&A Department **prior** to the start of any project. Only personnel with the proper minimum training will be authorized to perform any disturbance to asbestos/lead paint or assumed asbestos/lead paint containing materials, or be in the adjacent area of a disturbance.
3. Notify the ES&A Department at **325-8490** and leave a message with the time, name of the technician doing the work, date and exact locations in the school where they will be performing any disturbance. This call should take place immediately prior to disturbance, this phone number (**325-8490**) will go to voice mail, and the contractors are to provide notifications with above identified information, 24 hours a day. The Contractor is also required to notify their assigned WCSD Construction Department Project Managers and Assistant Project Managers of scheduled disturbances so they can also verify compliance with the contractors approved disturbance procedures.

WASHOE COUNTY SCHOOL DISTRICT
MATERIAL, WATER, AND LEAD DISTURBANCE PERMIT
CONTINUATION PAGE

4. Contractors must refer to this Material Disturbance Permit to determine what materials contain asbestos or lead and utilize the applicable lead/asbestos procedures. Some materials cannot be disturbed, and each specific material disturbance permit will identify what can be disturbed and provided material disturbance instructions. The minimum disturbance permits in this section of the material permit are in addition to any requirements listed in the material disturbance instructions. Any instance where 100% of the minimum asbestos/lead requirements are not followed, the District will immediately hire an environmental remediation contractor as well as an environmental consultant to properly clean up the contamination and perform air sampling. The contractor will be responsible for reimbursing the District for all costs due to any improper or unauthorized disturbances.
5. Contractors or technicians who are new to performing asbestos/lead paint or assumed asbestos/lead paint disturbances for the District must contact the Capital Projects PM/PCI Department and schedule a disturbance. A Capital Projects PM/PCI employee will be scheduled to review the technician's compliance with the disturbance procedures in the field. Once a technician has demonstrated on a minimum of two (2) occasions to the Capital Projects Department that he has an understanding of the District disturbance requirements and has proper equipment, the ES&A Department will then authorize that technician to perform disturbances without prior approval of the Capital Projects Department. Notifications prior to starting all disturbances as listed above will still be required and technicians should expect unannounced random compliance inspections, from the ES&A Department. A list of approved technicians is available upon request from the ES&A department.
6. Post the appropriate "Danger Lead - Keep Out" or "Danger Asbestos Keep Out" signs on the entry side of all doors leading into classrooms, hallways, bathrooms, offices or mechanical rooms where drilling is to occur. Doors will be closed. It is the contractor /technician's responsibility to take adequate means to keep the public or school staff out of the disturbance area.
7. Large rooms, such as multipurpose rooms, will have yellow caution tape placed across all entries to the room in addition to signage but access to these areas must be restricted to ensure no unprotected person can enter the areas where disturbances are taking place. If unprotected personnel can see the activity, this is not a large enough area of demarcation.
8. A 6 ml plastic drop will be placed under the disturbance in a manner that extends 6' out in all directions from the disturbance area. This poly drop can be reused if properly wet-wiped or HEPA-vacuumed off after use.
9. Worker will don the respiratory protection and a protective suit, (protective suits are optional for lead disturbance, "attachments and penetration" disturbances if the Contractor will not exceed the lead action level) and initiate personal air monitoring procedures per item #10 below. Respiratory protection is required throughout all asbestos/lead paint or assumed asbestos/lead paint disturbances in WCSD regardless of air sampling results.
10. If a Contractor is performing a **lead** attachments and penetrations (see the definition in #20 below), air sampling will be conducted at the start of the project. If air sampling results show the technicians performing the work is below the OSHA Lead Action Level, air sampling can be suspended unless the work being performed is changed. Air sampling will be performed for each type of lead attachment and penetration activity to develop a representative sample for each lead activity. Air sampling will be performed during **all** asbestos disturbances, no exceptions.
11. Drill the hole or holes as required using an HEPA VAC and a shrouded or dust collecting apparatus (i.e. Bit Buddy. A HEPA VAC is to remain running during this whole process to ensure all debris is cleared from hole. All clean-up must be conducted the HEPA Vacuum. If a contractor fails to properly control the asbestos/lead containing dust, the District will then hire an environmental remediation contractor as well as an environmental consultant to properly clean up the contamination. The contractor will be responsible for reimbursing the District for all costs due to improper disturbances that result in debris exiting the area of disturbance.
12. All HEPA vacuums used will have been DOP challenge tested prior to first use and annually thereafter. If this project involves 30 or more disturbances over the span of this project, the HEPA vacuum will be DOP tested on-site prior to the start of the project.

**WASHOE COUNTY SCHOOL DISTRICT
MATERIAL, WATER, AND LEAD DISTURBANCE PERMIT
CONTINUATION PAGE**

13. If required, to be determined by the technician, an encapsulant material may be sprayed or brushed on to the area of the holes.
14. A device, backing, box or raceway, or any other equipment will then be mounted using anchors installed per #11 above, with the HEPA VAC running and properly directed at the area of the disturbance.
15. A HEPA VAC or wet methods will be used to clean up any debris on 6ml poly drop, around device box, technician's suit, and any surfaces below holes, such as tops of chalkboards and base boards.
16. The poly drop, if utilized, will be folded into itself in such a manner as to not spread any debris, the HEPA vacuum hose sealed, and personal air monitoring time logged appropriately. This poly drop can be reused if it is properly wet-wiped or HEPA-vacuumed off after use.
17. All signs and equipment are to be removed, and the technician is to move to the next location. The contaminated suit should be removed and a new suit utilized at the new disturbance location, unless the suit can be properly decontaminated.
18. Upon completion of a shift, air samples will be dated and sent in to a properly accredited lab to be analyzed. Results will be forwarded to WCSD. Lab results will be e-mailed directly from the lab to the ES&A Department within 48 hours of the disturbance. All lab results will reference the Material Disturbance Permit (MDP) # located on the top of the first page of this permit. Results without the MDP number prefix will be returned to the lab for clarification and the addition of the MDP tracking number
19. All debris, waste, poly drop, suits, etc. will be placed in 6 mil poly waste bags (double bagged) and disposed of properly.
20. The definition of "Attachment and Penetrations" in this document is only the drilling of holes through a HEPA shrouded device, the installation of screws through a HEPA shrouded device, or the removal of screws through a HEPA shrouded device. Any other activity that is not attachments and penetrations as listed in item #20 must be designed by an asbestos or lead project designer, done per a lead specification, and supervised by the District or District hired outside asbestos/lead consultant. Contractors cannot perform any work, other than "Attachments and Penetrations" without an onsite District or District hired asbestos or Lead Consultant being present.
21. All asbestos abatement or lead disturbances, other than "Attachment and Penetrations", must be completed in full compliance with applicable regulations, the District's Asbestos Abatement Specifications, and District hired asbestos or lead consultants supplement specifications. If in error, an asbestos abatement bid or quote is put forth without the District Asbestos Abatement Specifications, Contractors are required to request a copy of the most current asbestos abatement specifications from the bid or quote entity through the formal bid inquiry process

THE UNDERSIGNED AGREES TO COMPLY WITH THE CONDITIONS OF THIS MATERIAL, WATER & LEAD DISTURBANCE PERMIT, APPENDIXES, & ALL APPLICABLE REGULATIONS. UNDERSIGNED ACKNOWLEDGES LIABILITY FOR ANY COSTS THE DISTRICT MAY INCUR TO INVESTIGATE & CLEAN UP ANY DISCOVERY OF IMPROPER AND/OR UNAUTHORIZED DISTURBANCES DONE BY UNDERSIGNED'S EMPLOYEE(S) OR SUB-CONTRACTOR(S) TO MATERIALS LISTED AS LEAD/ASBESTOS-CONTAINING BY THE DISTRICT. IN ADDITION, THE UNDERSIGNED AGREES TO ALL REQUIREMENTS OF THE WATER & LEAD APPENDIX.

SIGNED BY (PRINT): _____ SIGNATURE: _____

COMPANY (PRINT): _____

DATE RECEIVED: _____



March 24, 2025

Asbestos & Lead Survey Report

**Washoe County School District
Gomm Elementary School
Site Drainage Project
4000 Mayberry Drive
Reno, NV 89519**

Prepared for:

**Caitlin Davis, Design Project Manager II
Capital Projects & Planning
Washoe County School District
14101 Old Virginia Road
Reno, NV 89521
(775) 690-4938 |
john.caramore@washoeschools.net**

Prepared By:

**Daniel Prado, Assistant Director
Forensic Analytical Consulting Services
4600 Kietzke Lane, B118
Reno, NV 89502
775-391-3524 | danny.prado@facs.com**

FACS Project #PJ85697

Contents

List of Acronyms.....	1
Executive Summary	2
Introduction.....	4
Scope of Work	4
Site Characterization.....	4
Survey Methods	4
Regulations	7
Findings and Recommendations.....	8
Limitations.....	10

**Appendix A: Asbestos Survey Summary,
Sample Chain-of-Custody and Laboratory
Results Report**

**Appendix B: Lead Paint Chip Summary, Sample
Chain-of-Custody and Laboratory Results
Report**

**Appendix C: Site Photos and Sample Location
Drawings**

**Appendix D: Certifications of Personnel and
Laboratories**

List of Acronyms

AAC	Asbestos Abatement Consultant
AAS	Atomic Absorption Spectroscopy
ACM	Asbestos Containing Material
AHERA	Asbestos Hazard Emergency Response Act
AIHA	American Industrial Hygiene Association
CFR	Code of Federal Regulation
DIR	Division of Industrial Relations
ELAP	Environmental Laboratory Accreditation Program
EPA	Environmental Protection Agency (EPA)
FACS	Forensic Analytical Consulting Services, Inc.
FALI	Forensic Analytical Laboratories, Inc.
LCP	Lead-Containing Paints and Coatings
LBP	Lead-Based Paints and Coatings
ND	None Detected
NESHAP	National Emissions Standard Hazardous Air Pollutants
NIOSH	National Institute for Occupational Safety and Health
NIST	National Institute of Science and Technology
NVLAP	National Voluntary Laboratory Accreditation Program
PCM	Phase Contrast Microscopy
PLM	Polarized Light Microscopy
SGS	SGS - Forensic Laboratories
TEM	Transmission Electron Microscopy
TTLC	Total Threshold Limit Concentration

Executive Summary

Forensic Analytical Consulting Services, Inc. (FACS) was retained by Washoe County School District to perform an asbestos and lead paint survey at Gomm Elementary School, located at 4000 Mayberry Drive in Reno, Nevada. The survey included any suspect asbestos-containing materials (ACM) and suspect lead-containing paints and coatings which may be disturbed during the planned site drainage project. A summary list of suspect asbestos-containing materials which were identified and sampled is included in Appendix A of this report. A table reporting suspect lead-containing paints or coatings which were identified and sampled is included in Appendix B of this report. The survey was performed on March 4 and 10, 2025.

Asbestos

The following materials sampled during this survey were identified to **not contain** asbestos by laboratory analysis:

- Asphalt Patch
- Concrete Sidewalk
- Concrete Drains
- Concrete Playground Footings
- Concrete Fence Footings
- Concrete “Valley” Gutters
- Blue Vinyl Coating
- Black Vinyl Coating
- Red Vinyl Coating
- Dark Brown Vinyl Coating

Please see Appendix A for a complete listing of material samples at the project areas from this survey.

Any suspect materials not included must be assumed to be asbestos-containing materials until tested and proven not to contain asbestos.

Lead

The following paints sampled during this survey were found to be **lead-based** by laboratory analysis:

- Blue Paint on Metal Swing Set Pole
- Red Paint on Metal Hydrant

The following paints sampled during this survey and past surveys by the WCSD ES&A Department were found to be **lead-containing** by laboratory analysis:

- Light Blue Paint on Asphalt Lot
- Yellow Paint on Metal Play Structure
- Green Paint on Metal Handrail
- Red Paint on Concrete Curb

The following paints were found to **not contain** detectable amounts of lead by laboratory analysis:

- Blue Paint on Asphalt Lot
- Brown Paint on Asphalt Lot
- Green Paint on Asphalt Lot
- Seafoam Green Paint on Asphalt Lot
- Purple Paint on Asphalt Lot
- Red Paint on Asphalt Lot
- White Paint on Asphalt Lot
- Yellow Paint on Asphalt Lot
- Bright Yellow Paint on Asphalt Lot
- Black Paint on Metal Play Structure
- Black Paint on Metal Bench
- Blue Paint on Metal Bench
- Blue Paint on Metal Play Structure
- Green Paint on Metal Play Structure
- Kelly Green Paint on Metal Play Structure
- Orange Paint on Metal Table
- Burnt Orange Paint on Metal Play Structure
- Red Paint on Metal Tetherball Pole
- White Paint on Metal Play Structure
- Dusty Yellow Paint on Metal Play Structure

Please see Appendix B for a complete listing of results from the paints sampled at the project areas during this survey.

Any paints or coatings not included in the survey must be handled as lead-containing unless sampled and proven otherwise.

FACS recommends that the results of this report be incorporated into any renovation plans provided for this project for informational purposes.

Introduction

Forensic Analytical Consulting Services, Inc. (FACS) was retained by Washoe County School District to perform an asbestos and lead paint survey at Gomm Elementary School, located at 4000 Mayberry Drive in Reno, Nevada. The survey included any suspect asbestos-containing materials (ACM) and suspect lead-containing paints and coatings which may be disturbed during the planned site drainage project. The survey was performed on March 4 and 10, 2025.

Scope of Work

The purpose of this survey was to identify asbestos-containing materials (ACMs) and lead-containing paints and coatings which may be disturbed during the upcoming site drainage project. The visual inspection, bulk sampling, and survey documentation were performed by Daniel Prado, Danny Erickson, and Zachary Ramos. Mr. Prado, Mr. Erickson, and Mr. Ramos are licensed by the Division of Industrial Relations (DIR) as Asbestos Abatement Consultants (AAC), are US EPA-accredited Asbestos Hazard Emergency Response Act (AHERA) Building Inspectors, and are US EPA Certified Lead Inspectors. The scope of the survey and the services provided by FACS included:

- Performing a visual inspection to identify accessible suspect asbestos-containing materials (ACMs) and lead-containing paints and coatings that will be disturbed during the upcoming project;
- Collection of bulk samples for asbestos analysis by polarized light microscopy (PLM);
- Collection of bulk paint chip samples for lead analysis using inductively coupled plasma (ICP);
- Ensuring the technical quality of all work by using Asbestos Hazard Emergency Response Act (AHERA) accredited Building Inspectors;
- Ensuring the technical quality of all work by using a US EPA Certified Lead Inspector / Assessor; and
- Consolidating data and findings into a report format.

Site Characterization

The areas of the upcoming project involve the outdoor playground sections of the school on the east and south sides of the campus. Suspect asbestos-containing paints include various types of concrete, vinyl tread and glue on the play structures, and asphalt sealants. Suspect lead-containing paints were observed on all play structures, asphalt lots, curbs, benches, poles, and picnic tables.

Survey Methods

Document Review

Project plans were reviewed prior to the inspection. The extent of the planned site drainage project was provided by Caitlin Davis, Design Project Manager II, of Capital Projects and Planning for Washoe County School District.

Previous sampling results from the WCSD ES&A department were incorporated into this report as applicable.

Visual Inspection

Accessible building materials were visually inspected using the methods presented in the Federal AHERA regulations (40 CFR, Part 763). AHERA inspection methodology is required to be used for inspections of K-12 schools and is generally accepted as the industry standard for all ACM inspections regardless of structure or facility type. Suspect ACMs were also physically assessed for friability, condition and possible disturbance factors.

All areas were accessible during this inspection.

Asbestos Inspection

Bulk Sample Collection

Bulk samples of identified homogeneous materials were collected in building areas that may be impacted by the planned renovation/demolition activities. Samples were collected of each separate homogeneous area. A homogeneous area is defined as a surfacing material, thermal system insulation, or miscellaneous material that is uniform in use, color and texture. An example of a homogeneous area could include:

- Concrete
- Vinyl Coating & Glue
- Asphalt Sealant

The specific number of samples collected was determined by using the methods required by the Federal AHERA regulations (40 CFR, Part 763.86) as noted below:

- 1) For Surfacing Material:
 - 1,000 ft² or less - collect 3 samples
 - 1,001 to 5,000 ft² - collect 5 samples
 - 5,001 ft² or greater - collect 7 samples
- 2) For Thermal System Insulation:
 - “In a randomly distributed manner” - collect 3 samples
 - 6 linear feet of patching or less - collect 1 sample
 - cementitious pipe fittings - “In a manner sufficient to determine”
- 3) For all Miscellaneous Material:
 - Collect samples "In a manner sufficient to determine whether material is ACM (asbestos-containing material) or not ACM..."

Collect “A minimum of three bulk samples shall be collected of each homogeneous miscellaneous material, except that a single sample may suffice for small manufactured items such as HVAC vibration dampeners, gaskets and friction products. This exception applies to individual components of less than 6 ft² (0.557 m²) in size and not to multiple installations of similar components.” – ASTM E2356 – 18 Standard

The suspect ACMs were sampled using a knife, chisel, scraper, drill or other similar coring device suitable to the type of material sampled to cut through its entire thickness and to ensure that a cross-section of the material was obtained. The material was then placed in an appropriately labeled container that was sealed and submitted to WCSD Environmental Safety and Assessment (ES&A) Department.

Bulk Sample Analysis

A total of thirty (30) bulk samples were collected from a total of ten (10) suspect materials.

All bulk samples were delivered to WCSD Environmental Safety and Assessment (ES&A) Department for submission to Schneider Laboratories Global, Inc. (SLG) in Richmond, Virginia.

SLG is accredited by the National Institute of Science and Technology's (NIST) National Voluntary Laboratory Accreditation Program (NVLAP). SLG participates in the National Institute for Occupational Safety and Health (NIOSH) Proficiency Analytical Testing Program and has substantial experience in the analysis of asbestos.

All samples were analyzed using Polarized Light Microscopy with Dispersion Staining (PLM/DS) techniques in accordance with the methodology approved by the U.S. Environmental Protection Agency (EPA). The percentage of asbestos present in the samples was determined on the basis of a visual area estimation. The EPA defines asbestos-containing materials (ACM) as any material containing more than one percent (1%) asbestos as determined using the method specified in Appendix A, Subpart F, 40 CFR Part 763, Section 1, Polarized Light Microscopy (PLM). 40 CFR Part 763 identifies the lower limit of reliable quantification for asbestos using the PLM method as approximately one percent (1%) by volume. In addition to the percentages, the types of asbestos minerals are also reported. The PLM method is the standard method used to analyze asbestos bulk samples.

When "None Detected" (ND) appears in the laboratory results, it should be interpreted as meaning asbestos was not observed in the sample material.

Lead Inspection

The client-defined lead inspection was modeled upon the sampling protocol described in "Chapter 7: Lead Based Paint Inspection" of the HUD Guidelines for the Evaluation and Control of Lead-Based Paint Hazards in Housing (1997 Revision).

OSHA, in Title 29 Code of Federal Regulations (CFR) Part Number 1926, Standard Number 1926.62, regulates all construction work where an employee may be occupationally exposed to lead. Paints, coatings, or materials with any detectable level of lead is considered lead-containing by OSHA. Paints or coatings containing lead above 1.0 mg/cm², 0.5% by weight, or 5,000 parts per million are considered lead-based by the US EPA.

Bulk Sampling Methodology

During this inspection, FACS personnel collected seventy-eight (78) bulk paint chip samples from twenty-six (26) suspect paints and coatings for laboratory confirmation of lead-content. Each sample was scraped from the substrate it had been applied to using a knife or chisel to obtain sufficient material for analysis.

All bulk samples were delivered to WCSD Environmental Safety and Assessment (ES&A) Department for submission to Schneider Laboratories Global, Inc. (SLG) in Richmond, Virginia.

SLG is accredited by the American Industrial Hygiene Association's Environmental Lead Laboratory Accreditation Program for the analysis of lead in bulk paint chips by inductively coupled plasma.

Regulations

Background

Asbestos is the name of a class of magnesium-silicate minerals that occur in fibrous form. Minerals that are included in this group are chrysotile, crocidolite, amosite, anthophyllite asbestos, tremolite asbestos, and actinolite asbestos. Although the chrysotile minerals are the most common type of asbestos found in the construction industry, all types of asbestos are regulated in the same manner. Asbestos has been used in more than 3,000 different building materials. Asbestos was added to building materials to: increase fire-resistance, insulate against heat, cold and sound, resist corrosion, and increase tensile strength. Common building materials that may contain asbestos include but are not limited to the following: floor tile, resilient sheet flooring, ceiling tile, mastics, roofing materials, fireproofing, acoustical treatments, wallboard, pipe and boiler insulations. Adverse health effects have been associated with the inhalation of airborne asbestos. However, asbestos fibers that are tightly bound in the building material, may not represent an exposure hazard, unless disturbed in such a way that releases airborne fibers (i.e., cutting, drilling, sanding, and other abrasive methods).

Building Surveys

The following is a summary of some current Federal regulations which contain requirements related to the performance of building surveys for asbestos. These summaries are not intended to be all inclusive and do not contain every aspect of the regulations discussed.

U.S. EPA National Emission Standard for Hazardous Air Pollutants (NESHAPs), 40 CFR Part 61

Under the NESHAPs regulation, no visible emissions are allowed during building demolition or renovation activities which involve regulated asbestos-containing materials. For this reason, all buildings must be surveyed for asbestos-containing materials prior to demolition or renovation. The EPA, and/or the local Air Quality Management District which implements EPA actions, must be notified prior to any building demolition even if no asbestos-containing materials are present.

Regulated asbestos-containing material (RACM) is defined as a) any friable material with an asbestos content of greater than one percent, or b) any non-friable material with asbestos content of greater than one percent that will, or could, become friable.

Asbestos Hazard Emergency Response Act (AHERA), 40 CFR Part 763, Subpart E

AHERA requires performance of asbestos surveys and the development of Asbestos Management Plans for all primary and secondary schools in the United States. Although this regulation applies to primary and secondary schools only, the procedures mandated under AHERA are considered the industry standard and are applied to all surveys performed by FACS unless otherwise specified by the building owner.

Worker Protection

Occupational Safety and Health Administration (OSHA) 29 CFR 1926.1101 and 8 CCR 1529

The Federal and State Occupational Safety and Health Administrations (OSHA) require employers to implement specific work practices which protect workers from airborne asbestos exposure.

Building materials which contain even low levels of asbestos (<1%) can potentially generate significant concentrations of airborne asbestos fibers when disturbed. Therefore, control measures should be instituted which adequately address worker health and safety during planned renovation or demolition activities involving these materials.

Hazardous Waste

Building materials reported to contain less than one percent (<1%) of asbestos are not considered hazardous by the U.S. EPA, and hence, may not require removal and disposal prior to demolition or renovation. Regulations may vary, however, between regional air quality management districts and/or other state agencies responsible for implementing EPA's rules. Therefore, local agencies should be contacted for specific ACM definitions and handling requirements.

Composite sampling, which may potentially reduce the total asbestos content of the material, is only permitted when sampling joint compound, tape, and gypsum wallboard according to EPA's Asbestos NESHAP Clarification Regarding Analysis of Multi-Layered Systems (40 CFR Part 61 FRL-4821-7).

Lead

OSHA regulates the handling of paints and coatings containing lead down to any detectable concentration. Therefore, workers that will handle paints or coatings on this project must have lead training. For work with Washoe County School District, this training must be OSHA Action Level training at minimum. Any contractor with workers disturbing any quantity of detectable lead must perform an initial determination regarding worker exposures to lead, which may be based on personal air monitoring at the start of the project, prior employee monitoring from the past 12 months under workplace conditions closely resembling the current project, or objective data demonstrating that exposures will not exceed the OSHA action level (30 micrograms per cubic meter of air). It is the employer's responsibility to conduct the initial determination and comply with any relevant OSHA requirements.

Workers must use lead-safe work practices when disturbing paints or coatings that contain lead. Disturbance of lead-containing paints or coatings must be performed within a contained area to prevent the spread and build-up of lead dust. HEPA vacuums, dustless tools or shrouds, and/or intact removal of components should be employed to minimize lead dust generation and work areas must be properly cleaned following disturbance to lead-containing materials during this project. Waste generated during disturbance to lead-containing materials must be profiled in a hazardous waste determination to ascertain proper disposal requirements.

Findings and Recommendations

Forensic Analytical Consulting Services, Inc. (FACS) was retained by Washoe County School District to perform an asbestos and lead paint survey Gomm Elementary School, located at 4000 Mayberry Drive in Reno, Nevada. The survey was performed on March 4 and 10, 2025.

Asbestos

The following materials sampled during this survey were identified to **not contain** asbestos by laboratory analysis:

- Asphalt Patch
- Concrete Sidewalk
- Concrete Drains
- Concrete Playground Footings
- Concrete Fence Footings
- Concrete "Valley" Gutters
- Blue Vinyl Coating
- Black Vinyl Coating
- Red Vinyl Coating
- Dark Brown Vinyl Coating

Please see Appendix A for a complete listing of material samples at the project areas from this survey.

Any suspect materials not included must be assumed to be asbestos-containing materials until tested and proven not to contain asbestos.

Lead

The following paints sampled during this survey were found to be **lead-based** by laboratory analysis:

- Blue Paint on Metal Swing Set Pole
- Red Paint on Metal Hydrant

The following paints sampled during this survey and past surveys by the WCSD ES&A Department were found to be **lead-containing** by laboratory analysis:

- Light Blue Paint on Asphalt Lot
- Green Paint on Metal Handrail
- Yellow Paint on Metal Play Structure
- Red Paint on Concrete Curb

The following paints were found to **not contain** detectable amounts of lead by laboratory analysis:

- Blue Paint on Asphalt Lot
- Brown Paint on Asphalt Lot
- Green Paint on Asphalt Lot
- Seafoam Green Paint on Asphalt Lot
- Purple Paint on Asphalt Lot
- Red Paint on Asphalt Lot
- White Paint on Asphalt Lot
- Yellow Paint on Asphalt Lot
- Bright Yellow Paint on Asphalt Lot
- Black Paint on Metal Play Structure
- Black Paint on Metal Bench
- Blue Paint on Metal Bench
- Blue Paint on Metal Play Structure
- Green Paint on Metal Play Structure
- Kelly Green Paint on Metal Play Structure
- Orange Paint on Metal Table
- Burnt Orange Paint on Metal Play Structure
- Red Paint on Metal Tetherball Pole
- White Paint on Metal Play Structure
- Dusty Yellow Paint on Metal Play Structure

Please see Appendix B for a complete listing of results from the paints sampled at the project areas from this survey.

Any paints or coatings not included in the survey must be handled as lead-containing unless sampled and proven otherwise.

OSHA regulates the handling of paints and coatings containing lead down to any detectable concentration. Therefore, workers that will handle paints or coatings on this project must have lead training. For work with Washoe County School District, this training must be OSHA Action Level training at minimum. Any contractor with workers disturbing any quantity of detectable lead must perform an initial determination regarding worker exposures to lead, which may be based on personal air monitoring at the start of the project, prior employee monitoring from the past 12 months under workplace conditions closely resembling the current project, or objective data demonstrating that exposures will not exceed the OSHA action level (30 micrograms per cubic meter of air). It is the employer's responsibility to conduct the initial determination and comply with any relevant OSHA requirements.

Workers must use lead-safe work practices when disturbing paints or coatings that contain lead. Disturbance of lead-containing paints or coatings must be performed within a contained area to prevent the spread and build-up of lead dust. HEPA vacuums, dustless tools or shrouds, and/or intact removal of components should be employed to minimize lead dust generation and work areas must be properly cleaned following disturbance to lead-containing materials during this project. Waste generated during disturbance to lead-containing materials must be profiled in a hazardous waste determination to ascertain proper disposal requirements.

FACS recommends that the results of this report be incorporated into any plans provided for this project for informational purposes.

Limitations

This investigation is limited to the conditions and practices observed, and information made available to FACS. The methods, conclusions and recommendations provided are based on FACS' judgment, expertise, and the standard of practice for professional service. They are subject to the limitations and variability inherent in the methodology employed. As with all environmental investigations, this investigation is limited to the defined scope and does not purport to set forth all hazards, nor indicate that other hazards do not exist.

Please do not hesitate to contact our office at 775-993-7389 with any questions or concerns. Thank you for the opportunity to assist Washoe County School District with promoting worker safety and a healthy environment.

Respectfully,
FORENSIC ANALYTICAL



Daniel Prado
Assistant Director, Reno
IJPM-2057
US EPA LBP-R-1214705-2

Reviewed by:
FORENSIC ANALYTICAL



Chris Chipponeri
Director, Central Valley Offices
IJPM-1410
US EPA LBP-R-128230-3

Appendix A

Asbestos Survey Summary, Sample Chain-of-Custody and Laboratory Results Report

Asbestos Survey Summary (Lab Report #611382) WCSD – Gomm Elementary School – 4000 Mayberry Drive Reno, Nevada 89519 Survey Date: March 4 th and 10 th , 2025						
Sample Number	Material Description	Location(s) of Material	Material Number	Asbestos Content (%)	Asbestos NESHAP Category	Approximate Quantity (ft ²)
34635 34636 34637	Asphalt Patch	Exterior Paved Areas	1	None detect in black bituminous asphalt patch	NA	NA
34638 34639 34640	Concrete Drains	Exterior Paved Areas	2	None detect in gray hard concrete	NA	NA
34641 34642 34643	Concrete Fence Footings	Perimeter Fence Line of Campus	3	None detect in gray hard concrete	NA	NA
34644 34645 34646	Concrete Playground Footings	All Play Structure, Pole, and Swing Sets	4	None detect in gray hard concrete	NA	NA
34647 34648 34649	Concrete Sidewalks	Along Building A, D, & Parking Lot	5	None detect in gray hard concrete	NA	NA
34650 34651 34652	Concrete Valley Gutters	Exterior Paved Areas	6	None detect in gray hard concrete	NA	NA
34653 34654 34655	Vinyl Coating – Black	East Center Play Structure	7	None detect in black rubbery vinyl coating	NA	NA
34656 34657 34658	Vinyl Coating – Blue	Northeast Play Structure	8	None detect in blue soft vinyl coating	NA	NA

Asbestos Survey Summary (Lab Report #611382) WCSD – Gomm Elementary School – 4000 Mayberry Drive Reno, Nevada 89519 Survey Date: March 4 th and 10 th , 2025						
Sample Number	Material Description	Location(s) of Material	Material Number	Asbestos Content (%)	Asbestos NESHAP Category	Approximate Quantity (ft ²)
34659 34660 34661	Vinyl Coating – Dark Brown	Southeast Play Structure	9	None detect in dark brown rubbery vinyl coating	NA	NA
34662 34663 34664	Vinyl Coating – Red	South of Center Play Structure	10	None detect in red rubbery vinyl coating	NA	NA



Customer: Washoe County School District (4991)
Address: 7495 S. Virginia Street
Reno, NV 89511

Order #:	611382
-----------------	--------

Received 03/17/25
Analyzed 03/20/25
Reported 03/20/25

Attn:

Project:

Location: 130 - Roy Gomm ES
Number:

PO Number: PO223225

Method: EPA 600/R-93/116 & 40 CFR App. E Sub. E Pt. 763

PLM Analysis

Sample ID	Collected	Cust. ID	Location	Asbestos Fibers	Other Materials
611382-001	03/10/25	130-5069-34635	Bldg. D Play Area Ctr		
Layer 1:	Asphalt Patch Black, Bituminous			No Asbestos Detected	100% NON FIBROUS MATERIAL
611382-002	03/10/25	130-5069-34636	N Swing Set W Side Ctr		
Layer 1:	Asphalt Patch Black, Bituminous			No Asbestos Detected	100% NON FIBROUS MATERIAL
611382-003	03/10/25	130-5069-34637	Bldg. D Play Area E Side		
Layer 1:	Asphalt Patch Black, Bituminous			No Asbestos Detected	100% NON FIBROUS MATERIAL
611382-004	03/10/25	130-5069-34638	Bldg. D Play Area W Side		
Layer 1:	Concrete(Drains) Gray, Hard			No Asbestos Detected	100% NON FIBROUS MATERIAL
611382-005	03/10/25	130-5069-34639	N Swing Set NW Corner		
Layer 1:	Concrete(Drains) Gray, Hard			No Asbestos Detected	100% NON FIBROUS MATERIAL
611382-006	03/10/25	130-5069-34640	Bldg. D Play Area W Side		
Layer 1:	Concrete(Drains) Gray, Hard			No Asbestos Detected	100% NON FIBROUS MATERIAL
611382-007	03/10/25	130-5069-34641	Campus E Side Ctr		
Layer 1:	Concrete(Fence Footings) Gray, Hard			No Asbestos Detected	100% NON FIBROUS MATERIAL

Reporting Limit: 1% Gravimetrically Reduced Reporting Limit: 0.01% PLM analysis is based on Visual Estimation and NESHAP recommends that any friable sample with an asbestos content less than 10 percent be verified by Point Count or TEM Analysis. The EPA recommends that any attic loose fill vermiculite should be treated as asbestos containing material. This report must not be reproduced except in full with the approval of the laboratory. The test results apply to the sample as received.

Project:**Location:** 130 - Roy Gomm ES**Number:****PO Number:**

PO223225

Method: EPA 600/R-93/116 & 40 CFR App. E Sub. E Pt. 763**PLM Analysis**

Sample ID	Collected	Cust. ID	Location	Asbestos Fibers	Other Materials
611382-008	03/10/25	130-5069-34642	N Swing Set NW Corner		
Layer 1:	Concrete(Fence Footings) Gray, Hard			No Asbestos Detected	100% NON FIBROUS MATERIAL
611382-009	03/10/25	130-5069-34643	Campus E Side N End		
Layer 1:	Concrete(Fence Footings) Gray, Hard			No Asbestos Detected	100% NON FIBROUS MATERIAL
611382-010	03/10/25	130-5069-34644	N Swing Set E Side Ctr		
Layer 1:	Concrete(Playground Footings) Gray, Hard			No Asbestos Detected	100% NON FIBROUS MATERIAL
611382-011	03/10/25	130-5069-34645	SE Tetherball Poles N		
Layer 1:	Concrete(Playground Footings) Gray, Hard			No Asbestos Detected	100% NON FIBROUS MATERIAL
611382-012	03/10/25	130-5069-34646	S Swing Set Ctr of Area		
Layer 1:	Concrete(Playground Footings) Gray, Hard			No Asbestos Detected	100% NON FIBROUS MATERIAL
611382-013	03/10/25	130-5069-34647	Bldg D Play Area NW		
Layer 1:	Concrete(Sidewalks) Gray, Hard			No Asbestos Detected	100% NON FIBROUS MATERIAL
611382-014	03/10/25	130-5069-34648	Bldg A E Side Ctr		
Layer 1:	Concrete(Sidewalks) Gray, Hard			No Asbestos Detected	100% NON FIBROUS MATERIAL
611382-015	03/10/25	130-5069-34649	Bldg A SE Corner at HR		
Layer 1:	Concrete(Sidewalks) Gray, Hard			No Asbestos Detected	100% NON FIBROUS MATERIAL
611382-016	03/10/25	130-5069-34650	E Swing Set SW Corner		
Layer 1:	Concrete(Valley Gutters) Gray, Hard			No Asbestos Detected	100% NON FIBROUS MATERIAL
611382-017	03/10/25	130-5069-34651	Bldg A SE Corner		
Layer 1:	Concrete(Valley Gutters) Gray, Hard			No Asbestos Detected	100% NON FIBROUS MATERIAL

Reporting Limit: 1% Gravimetrically Reduced Reporting Limit: 0.01% PLM analysis is based on Visual Estimation and NESHAP recommends that any friable sample with an asbestos content less than 10 percent be verified by Point Count or TEM Analysis. The EPA recommends that any attic loose fill vermiculite should be treated as asbestos containing material. This report must not be reproduced except in full with the approval of the laboratory. The test results apply to the sample as received.

Project:**Location:** 130 - Roy Gomm ES**Number:****PO Number:**

PO223225

Method: EPA 600/R-93/116 & 40 CFR App. E Sub. E Pt. 763**PLM Analysis**

Sample ID	Collected	Cust. ID	Location	Asbestos Fibers	Other Materials
611382-018	03/10/25	130-5069-34652	Bldg A SE Corner at HR		
Layer 1:	Concrete(Valley Gutters) Gray, Hard			No Asbestos Detected	100% NON FIBROUS MATERIAL
611382-019	03/10/25	130-5069-34653	E Ctr Play Struct S Side		
Layer 1:	Vinyl Coating Black, Rubbery			No Asbestos Detected	100% NON FIBROUS MATERIAL
611382-020	03/10/25	130-5069-34654	E Ctr Play Struct NE		
Layer 1:	Vinyl Coating Black, Rubbery			No Asbestos Detected	100% NON FIBROUS MATERIAL
611382-021	03/10/25	130-5069-34655	E Ctr Play Struct NE		
Layer 1:	Vinyl Coating Black, Rubbery			No Asbestos Detected	100% NON FIBROUS MATERIAL
611382-022	03/10/25	130-5069-34656	NE Play Struc S Side Ctr		
Layer 1:	Vinyl Coating Blue, Soft			No Asbestos Detected	100% NON FIBROUS MATERIAL
611382-023	03/10/25	130-5069-34657	NE Play Struct S Side Ctr		
Layer 1:	Vinyl Coating Blue, Soft			No Asbestos Detected	100% NON FIBROUS MATERIAL
611382-024	03/10/25	130-5069-34658	NE Play Struct E Side Ctr		
Layer 1:	Vinyl Coating Blue, Soft			No Asbestos Detected	100% NON FIBROUS MATERIAL
611382-025	03/10/25	130-5069-34659	SE Play Struct Ctr		
Layer 1:	Vinyl Coating Dark Brown, Rubbery			No Asbestos Detected	100% NON FIBROUS MATERIAL
611382-026	03/10/25	130-5069-34660	SE Play Struct Ctr		
Layer 1:	Vinyl Coating Dark Brown, Rubbery			No Asbestos Detected	100% NON FIBROUS MATERIAL
611382-027	03/10/25	130-5069-34661	SE Play Struct Ctr		
Layer 1:	Vinyl Coating Dark Brown, Rubbery			No Asbestos Detected	100% NON FIBROUS MATERIAL

Reporting Limit: 1% Gravimetrically Reduced Reporting Limit: 0.01% PLM analysis is based on Visual Estimation and NESHAP recommends that any friable sample with an asbestos content less than 10 percent be verified by Point Count or TEM Analysis. The EPA recommends that any attic loose fill vermiculite should be treated as asbestos containing material. This report must not be reproduced except in full with the approval of the laboratory. The test results apply to the sample as received.

Project:

Location: 130 - Roy Gomm ES
Number:

PO Number: PO223225

Method: EPA 600/R-93/116 & 40 CFR App. E Sub. E Pt. 763

PLM Analysis

Sample ID	Collected	Cust. ID	Location	Asbestos Fibers	Other Materials
611382-028	03/10/25	130-5069-34662	S of Ctr Play Struct E		
Layer 1:	Vinyl Coating			No Asbestos Detected	100% NON FIBROUS MATERIAL
	Red, Rubbery				
611382-029	03/10/25	130-5069-34663	S of Ctr Play Struct Ctr		
Layer 1:	Vinyl Coating			No Asbestos Detected	100% NON FIBROUS MATERIAL
	Red, Rubbery				
611382-030	03/10/25	130-5069-34664	S of Ctr Play Struct Ctr		
Layer 1:	Vinyl Coating			No Asbestos Detected	100% NON FIBROUS MATERIAL
	Red, Rubbery				

EPA Regulatory Limit: 1%
Total layers analyzed on order: 30



Analyst **Thoria Nadiem**

611382-03/20/25 12:46 PM

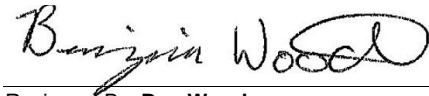

Reviewed By: **Ben Wood**
Laboratory Director

Reporting Limit: 1% Gravimetrically Reduced Reporting Limit: 0.01% PLM analysis is based on Visual Estimation and NESHAP recommends that any friable sample with an asbestos content less than 10 percent be verified by Point Count or TEM Analysis. The EPA recommends that any attic loose fill vermiculite should be treated as asbestos containing material. This report must not be reproduced except in full with the approval of the laboratory. The test results apply to the sample as received.

Charge to C.C.

WCSD BULK SAMPLE CHAIN OF CUSTODY FORM

Requested By: John Nolan

Phone Number: 775-325-8491

Fax Number: 775-851-5662

Analysis Type: PLM, PCM, TEM

Analysis Turn Around Time: 2hr, Same Day, 1 Day, 2 Day, 3 Day, 5 Day

Instructions: Email results to the ESA Department, and produce a separate report for each facility. New prefix numbers on a sample identifies a new site. ACCT. #4991

<u>SAMPLE #</u>	<u>DATE</u>	<u>MAT. DESCRIPTION</u>	<u>LOCATION</u>	<u>ROOM</u>	<u>SITE</u>
130 - 5069 - 34635	3/10/2025	Asphalt Patch	Building D Play Area - Center.	Exterior	130 - Roy Gomm ES
130 - 5069 - 34636	3/10/2025	Asphalt Patch	North Swing Set - W Side Center.	Exterior	130 - Roy Gomm ES
130 - 5069 - 34637	3/10/2025	Asphalt Patch	Building D Play Area - E Side Center.	Exterior	130 - Roy Gomm ES
130 - 5069 - 34638	3/10/2025	Concrete (Drains)	Building D Play Area - W Side Center.	Exterior	130 - Roy Gomm ES
130 - 5069 - 34639	3/10/2025	Concrete (Drains)	North Swing Set - NW Corner.	Exterior	130 - Roy Gomm ES
130 - 5069 - 34640	3/10/2025	Concrete (Drains)	Building D Play Area - W Side Center.	Exterior	130 - Roy Gomm ES
130 - 5069 - 34641	3/10/2025	Concrete (Fence Footings)	Campus - East Side Center.	Exterior	130 - Roy Gomm ES
130 - 5069 - 34642	3/10/2025	Concrete (Fence Footings)	North Swing Set - NW Corner.	Exterior	130 - Roy Gomm ES
130 - 5069 - 34643	3/10/2025	Concrete (Fence Footings)	Campus - E Side N End.	Exterior	130 - Roy Gomm ES
130 - 5069 - 34644	3/10/2025	Concrete (Playground Footings)	North Swing Set - E Side Center.	Exterior	130 - Roy Gomm ES
130 - 5069 - 34645	3/10/2025	Concrete (Playground Footings)	SE Tetherball Poles - N Pole.	Exterior	130 - Roy Gomm ES
130 - 5069 - 34646	3/10/2025	Concrete (Playground Footings)	South Swing Set - Center Of Area.	Exterior	130 - Roy Gomm ES

SENT BY: Brian Priest

DATE/TIME: 3-12-25 7:17 AM

RECEIVED BY: ALAN J.

DATE/TIME: 3/17/25 7:28 AM

RECEIVED BY:

DATE/TIME:

RECEIVED BY:

DATE/TIME:

S 30

611382

V:\611\611382

ajackson
U.S. Mail

3/17/2025 7:24:36 AM

N/A

Charge to C.C.

WCSD BULK SAMPLE CHAIN OF CUSTODY FORM

Requested By: John Nolan

Phone Number: 775-325-8491

Fax Number: 775-851-5662

Analysis Type: PLM, PCM, TEM Analysis Turn Around Time: 2hr, Same Day, 1 Day, 2 Day, 3 Day, 5 Day

Instructions: Email results to the ESA Department, and produce a separate report for each facility. New prefix numbers on a sample identifies a new site. ACCT. #4991

<u>SAMPLE #</u>	<u>DATE</u>	<u>MAT. DESCRIPTION</u>	<u>LOCATION</u>	<u>ROOM</u>	<u>SITE</u>
130 - 5069 - 34647	3/10/2025	Concrete (Sidewalks)	Building D Play Area - NW Corner.	Exterior	130 - Roy Gomm ES
130 - 5069 - 34648	3/10/2025	Concrete (Sidewalks)	Building A - E Side Center.	Exterior	130 - Roy Gomm ES
130 - 5069 - 34649	3/10/2025	Concrete (Sidewalks)	Building A - SE Corner At Handrails.	Exterior	130 - Roy Gomm ES
130 - 5069 - 34650	3/10/2025	Concrete (Valley Gutters)	East Swing Set - SW Corner.	Exterior	130 - Roy Gomm ES
130 - 5069 - 34651	3/10/2025	Concrete (Valley Gutters)	Building A - SE Corner.	Exterior	130 - Roy Gomm ES
130 - 5069 - 34652	3/10/2025	Concrete (Valley Gutters)	Building A - SE Corner At Handrails.	Exterior	130 - Roy Gomm ES
130 - 5069 - 34653	3/10/2025	Vinyl Coating - Black	East Center Play Structure - S Side Center.	Exterior	130 - Roy Gomm ES
130 - 5069 - 34654	3/10/2025	Vinyl Coating - Black	East Center Play Structure - NE Corner.	Exterior	130 - Roy Gomm ES
130 - 5069 - 34655	3/10/2025	Vinyl Coating - Black	East Center Play Structure - NE Corner.	Exterior	130 - Roy Gomm ES
130 - 5069 - 34656	3/10/2025	Vinyl Coating - Blue	NE Play Structure - S Side Center.	Exterior	130 - Roy Gomm ES
130 - 5069 - 34657	3/10/2025	Vinyl Coating - Blue	NE Play Structure - S Side Center.	Exterior	130 - Roy Gomm ES
130 - 5069 - 34658	3/10/2025	Vinyl Coating - Blue	NE Play Structure - E Side Center.	Exterior	130 - Roy Gomm ES

SENT BY: Brian Priest

DATE/TIME: 3-12-25 7:17AM

RECEIVED BY: ALANI J.

DATE/TIME: 3/17/25 7:25AM

RECEIVED BY: _____

DATE/TIME: _____

RECEIVED BY: _____

DATE/TIME: _____

Charge to C.C.

WCSD BULK SAMPLE CHAIN OF CUSTODY FORM

Requested By: John Nolan

Phone Number: 775-325-8491

Fax Number: 775-851-5662

Analysis Type: PLM, PCM, TEM Analysis Turn Around Time: 2hr, Same Day, 1 Day, 2 Day, 3 Day, 5 Day

Instructions: Email results to the ESA Department, and produce a separate report for each facility. New prefix numbers on a sample identifies a new site. ACCT. #4991

<u>SAMPLE #</u>	<u>DATE</u>	<u>MAT. DESCRIPTION</u>	<u>LOCATION</u>	<u>ROOM</u>	<u>SITE</u>
130 - 5069 - 34659	3/10/2025	Vinyl Coating - Dark Brown	SE Play Structure - Center.	Exterior	130 - Roy Gomm ES
130 - 5069 - 34660	3/10/2025	Vinyl Coating - Dark Brown	SE Play Structure - Center.	Exterior	130 - Roy Gomm ES
130 - 5069 - 34661	3/10/2025	Vinyl Coating - Dark Brown	SE Play Structure - Center.	Exterior	130 - Roy Gomm ES
130 - 5069 - 34662	3/10/2025	Vinly Coating - Red	South Of Center Play Structure - E Side Center.	Exterior	130 - Roy Gomm ES
130 - 5069 - 34663	3/10/2025	Vinly Coating - Red	South Of Center Play Structure - Center.	Exterior	130 - Roy Gomm ES
130 - 5069 - 34664	3/10/2025	Vinly Coating - Red	South Of Center Play Structure - Center.	Exterior	130 - Roy Gomm ES

SENT BY: Brian Priest

RECEIVED BY: ALANNE J.

RECEIVED BY:

RECEIVED BY:

DATE/TIME: 3-17-25 7:17AM

DATE/TIME: 3/17/25 7:25 AM

DATE/TIME:

DATE/TIME:

Appendix B

Lead Paint Chip Summary, Sample Chain-of-Custody and Laboratory Results Report

Lead Paint Chip Summary (Lab Report #611383) WCSD – Gomm Elementary School – 4000 Mayberry Drive Reno, Nevada 89519 Survey Date: March 4th and 10th, 2025					
Sample Number	Component Location	Component	Color	Substrate	Analytical Results (mg/kg)
15464	Nevada Map – NW Corner	Lot	Light Blue	Asphalt	534
15465	USA Map – S Side Center	Lot	Light Blue	Asphalt	12.7
15466	USA Map – SW Corner	Lot	Light Blue	Asphalt	< 10.3
15467	Nevada Map – NW Corner	Lot	Blue	Asphalt	< 9.94
15468	Nevada Map – NE Corner	Lot	Blue	Asphalt	< 10.1
15469	Nevada Map – NE Corner	Lot	Blue	Asphalt	< 9.69
15470	USA Map – NW Corner	Lot	Brown	Asphalt	< 9.23
15471	USA Map – NW Corner	Lot	Brown	Asphalt	< 9.18
15472	USA Map – S Side Center	Lot	Brown	Asphalt	< 10.1
15473	USA Map – N of Center	Lot	Green	Asphalt	< 10.3
15474	USA Map – W Side Center	Lot	Green	Asphalt	< 8.99
15475	Nevada Map – E Side Center	Lot	Green	Asphalt	< 9.29
15476	Building D Play Area – W Side Center	Lot	Seafoam Green	Asphalt	< 9.09
15477	Building D Play Area – SE Corner	Lot	Seafoam Green	Asphalt	< 9.97
15478	Building D Play Area – W Side Center	Lot	Seafoam Green	Asphalt	< 8.89
15479	USA Map – Center	Lot	Purple	Asphalt	< 10.2
15480	Nevada Map – E Side Center	Lot	Purple	Asphalt	< 10.3
15481	USA Map – E Side N End	Lot	Purple	Asphalt	< 8.94

Lead Paint Chip Summary (Lab Report #611383) WCSD – Gomm Elementary School – 4000 Mayberry Drive Reno, Nevada 89519 Survey Date: March 4 th and 10 th , 2025					
Sample Number	Component Location	Component	Color	Substrate	Analytical Results (mg/kg)
15482	Nevada Map – SE Corner	Lot	Red	Asphalt	< 10.1
15483	USA Map – S Side Center	Lot	Red	Asphalt	< 9.88
15484	USA Map – S Side Center	Lot	Red	Asphalt	< 9.78
15485	USA Map – N Side Center	Lot	White	Asphalt	< 9.29
15486	Nevada Map – Center at Hydrant	Lot	White	Asphalt	< 9.72
15487	Nevada Map – E Side Center	Lot	White	Asphalt	< 9.69
15488	USA Map – W Side Center	Lot	Yellow	Asphalt	< 9.75
15489	Nevada Map – Center	Lot	Yellow	Asphalt	< 9.57
15490	USA Map – E Side Center	Lot	Yellow	Asphalt	< 9.85
15491	Building D Play Area – N Side Center	Lot	Bright Yellow	Asphalt	< 9.43
15492	Building D Play Area – W of Center	Lot	Bright Yellow	Asphalt	< 9.91
15493	Building D Play Area – W Side Center	Lot	Bright Yellow	Asphalt	< 9.63
15494	SE Play Structure – N Side Center	Pole	Black	Metal	< 9.37
15495	SE Play Structure – S Side E End	Pole	Black	Metal	< 9.88
15496	SE Play Structure – S Side W End	Pole	Black	Metal	< 9.57
15497	NW Bench	Bench	Black	Metal	< 9.54
15498	NE Bench	Bench	Black	Metal	< 9.78
15499	NE Bench	Bench	Black	Metal	< 9.85

Lead Paint Chip Summary (Lab Report #611383) WCSD – Gomm Elementary School – 4000 Mayberry Drive Reno, Nevada 89519 Survey Date: March 4 th and 10 th , 2025					
Sample Number	Component Location	Component	Color	Substrate	Analytical Results (mg/kg)
15500	NE Bench	Bench	Blue	Metal	< 9.26
15501	NE Bench	Bench	Blue	Metal	< 9.60
15502	NW Bench	Bench	Blue	Metal	< 10.4
15503	SW Play Structure – E Side Center	Pole	Blue	Metal	< 10.2
15504	E Center Play Structure – SW Corner	Pole	Blue	Metal	< 9.88
15505	Jungle Gym – E Side Center	Pole	Blue	Metal	< 15.7
15506	NW Swing Set – N Side Center	Pole	Blue	Metal	12,600
15507	E Swing Set – SW Corner	Pole	Blue	Metal	371
15508	E Swing Set – SE Corner	Pole	Blue	Metal	71.2
15509	SE Play Structure – W Side Center	Pole	Green	Metal	< 10.4
15510	SE Play Structure – E Side Center	Pole	Green	Metal	< 10.2
15511	SE Play Structure – Center	Pole	Green	Metal	< 10.4
15512	N Play Structure – NW Corner	Post	Kelly Green	Metal	< 10.1
15513	N Play Structure – SE Corner	Post	Kelly Green	Metal	< 9.46
15514	N Play Structure – Center	Post	Kelly Green	Metal	< 15.3
15515	S Table – NE Corner	Table	Orange	Metal	< 8.89
15516	S Table – SW Corner	Table	Orange	Metal	< 9.69
15517	N Table – NW Corner	Table	Orange	Metal	< 9.48

Lead Paint Chip Summary (Lab Report #611383) WCSD – Gomm Elementary School – 4000 Mayberry Drive Reno, Nevada 89519 Survey Date: March 4 th and 10 th , 2025					
Sample Number	Component Location	Component	Color	Substrate	Analytical Results (mg/kg)
15518	SW Play Structure – Center	Pole	Burnt Orange	Metal	< 9.72
15519	SW Play Structure – S Side Center	Pole	Burnt Orange	Metal	< 9.94
15520	SW Play Structure – SW Corner	Pole	Burnt Orange	Metal	< 16.0
15521	SE Tetherball Poles – S Pole	Pole	Red	Metal	< 9.78
15522	SE Tetherball Poles – N Pole	Pole	Red	Metal	< 9.40
15523	SE Tetherball Poles – S Pole	Pole	Red	Metal	< 9.57
15524	Nevada Map – N Side Center	Hydrant	Red	Metal	2700
15525	Nevada Map – N Side Center	Hydrant	Red	Metal	3090
15526	Nevada Map – N Side Center	Hydrant	Red	Metal	10,400
15527	S of Center Play Structure – S Side W End	Pole	White	Metal	< 9.91
15528	S of Center Play Structure – N Side Center	Pole	White	Metal	< 9.85
15529	S of Center Play Structure – SE Corner	Pole	White	Metal	< 9.07
15530	E Center Play Structure – Center	Pole	Yellow	Metal	15.1
15531	E Center Play Structure – E Side Center	Pole	Yellow	Metal	< 9.72
15532	E Center Play Structure – NE Corner	Spiral Pole	Yellow	Metal	17.9
15533	SW Play Structure – N Side W End	Pole	Dusty Yellow	Metal	< 9.15
15534	SW Play Structure – N Side Center	Pole	Dusty Yellow	Metal	< 9.63
15535	SW Play Structure – N Side W End	Pole	Dusty Yellow	Metal	< 9.29



Analysis Report

Schneider Laboratories Global, Inc

2512 W. Cary Street • Richmond, Virginia • 23220-5117
804-353-6778 • 800-785-LABS (5227) • Fax 804-359-1475

Customer: Washoe County School District (4991)
Address: 7495 S. Virginia Street
Reno, NV 89511

Order #: 611383

Matrix: Paint
Received: 03/17/25
Reported: 03/20/25

Attn:
Project:
Location: 130 - Roy Gomm ES
Number:

PO Number: PO224939

Table with columns: Sample ID, Cust. Sample ID, Location, Parameter, Method, Result, RL*, Units, Analysis Date, Analyst. Contains 10 rows of metal analysis data for Lead.

All internal QC parameters were met. Unusual sample conditions, if any, are described. Surrogate Spike results designated with "D" indicate that the analyte was diluted out. "MI" indicates matrix interference. Concentration and *Reporting Limit (RL) based on areas provided by client. Values are reported to three significant figures. Solid PPM = mg/kg | PPB = µg/kg and Water PPM = mg/L | PPB = µg/L. The test results apply to the sample as received.



Analysis Report

Schneider Laboratories Global, Inc

2512 W. Cary Street • Richmond, Virginia • 23220-5117
804-353-6778 • 800-785-LABS (5227) • Fax 804-359-1475

Customer: Washoe County School District (4991)
Address: 7495 S. Virginia Street
Reno, NV 89511

Order #:	611383
-----------------	--------

Matrix Paint
Received 03/17/25
Reported 03/20/25

Attn:
Project:
Location: 130 - Roy Gomm ES
Number:

PO Number: PO224939

Sample ID	Cust. Sample ID	Location	Result	RL*	Units	Analysis Date	Analyst
Parameter		Method					
611383-011	130PB-5069-15474	USA Map-W Side Ctr					
Metals Analysis							
Lead		EPA 6010D / 3050B	<8.99	8.99	mg/kg	03/17/25	DB
611383-012	130PB-5069-15475	Nevada Map-E Side Ctr					
Metals Analysis							
Lead		EPA 6010D / 3050B	<9.29	9.28	mg/kg	03/17/25	DB
611383-013	130PB-5069-15476	Bldg D Play Area-W Ctr					
Metals Analysis							
Lead		EPA 6010D / 3050B	<9.09	9.09	mg/kg	03/17/25	DB
611383-014	130PB-5069-15477	Bldg D Play Area-SW Cnr					
Metals Analysis							
Lead		EPA 6010D / 3050B	<9.97	9.97	mg/kg	03/17/25	DB
611383-015	130PB-5069-15478	Bldg D Play Area-W Ctr					
Metals Analysis							
Lead		EPA 6010D / 3050B	<8.89	8.88	mg/kg	03/17/25	DB
611383-016	130PB-5069-15479	USA Map-Ctr					
Metals Analysis							
Lead		EPA 6010D / 3050B	<10.2	10.1	mg/kg	03/17/25	DB
611383-017	130PB-5069-15480	Nevada Map-E Side Ctr					
Metals Analysis							
Lead		EPA 6010D / 3050B	<10.3	10.3	mg/kg	03/17/25	DB
611383-018	130PB-5069-15481	USA Map-E Side N End					
Metals Analysis							
Lead		EPA 6010D / 3050B	<8.94	8.93	mg/kg	03/17/25	DB
611383-019	130PB-5069-15482	Nevada Map-SE Cnr					
Metals Analysis							
Lead		EPA 6010D / 3050B	<10.1	10.1	mg/kg	03/17/25	DB
611383-020	130PB-5069-15483	USA Map-S Side Ctr					
Metals Analysis							
Lead		EPA 6010D / 3050B	<9.88	9.87	mg/kg	03/17/25	DB

All internal QC parameters were met. Unusual sample conditions, if any, are described. Surrogate Spike results designated with "D" indicate that the analyte was diluted out. "MI" indicates matrix interference. Concentration and *Reporting Limit (RL) based on areas provided by client. Values are reported to three significant figures. Solid PPM = mg/kg | PPB = µg/kg and Water PPM = mg/L | PPB = µg/L. The test results apply to the sample as received.



Analysis Report

Schneider Laboratories Global, Inc

2512 W. Cary Street • Richmond, Virginia • 23220-5117
804-353-6778 • 800-785-LABS (5227) • Fax 804-359-1475

Customer: Washoe County School District (4991)
Address: 7495 S. Virginia Street
Reno, NV 89511

Order #:	611383
-----------------	--------

Matrix Paint
Received 03/17/25
Reported 03/20/25

Attn:
Project:
Location: 130 - Roy Gomm ES
Number:

PO Number: PO224939

Sample ID	Cust. Sample ID	Location	Result	RL*	Units	Analysis Date	Analyst
Parameter		Method					
611383-021	130PB-5069-15484	USA Map-S Side Ctr					
Metals Analysis							
Lead		EPA 6010D / 3050B	<9.78	9.78	mg/kg	03/17/25	DB
611383-022	130PB-5069-15485	USA Map-N Side Ctr					
Metals Analysis							
Lead		EPA 6010D / 3050B	<9.29	9.28	mg/kg	03/17/25	DB
611383-023	130PB-5069-15486	Nevada Map-Ctr At Hydrant					
Metals Analysis							
Lead		EPA 6010D / 3050B	<9.72	9.72	mg/kg	03/17/25	DB
611383-024	130PB-5069-15487	Nevada Map-E Side Ctr					
Metals Analysis							
Lead		EPA 6010D / 3050B	<9.69	9.69	mg/kg	03/17/25	DB
611383-025	130PB-5069-15488	USA Map-W Side Ctr					
Metals Analysis							
Lead		EPA 6010D / 3050B	<9.75	9.75	mg/kg	03/17/25	DB
611383-026	130PB-5069-15489	Nevada Map-Ctr					
Metals Analysis							
Lead		EPA 6010D / 3050B	<9.57	9.57	mg/kg	03/17/25	DB
611383-027	130PB-5069-15490	USA Map-E Side Ctr					
Metals Analysis							
Lead		EPA 6010D / 3050B	<9.85	9.84	mg/kg	03/17/25	DB
611383-028	130PB-5069-15491	Bldg D Play Area-N Ctr					
Metals Analysis							
Lead		EPA 6010D / 3050B	<9.43	9.42	mg/kg	03/17/25	DB
611383-029	130PB-5069-15492	Bldg D Play Area-W Ctr					
Metals Analysis							
Lead		EPA 6010D / 3050B	<9.91	9.90	mg/kg	03/17/25	DB
611383-030	130PB-5069-15493	Bldg D Play Area-W Ctr					
Metals Analysis							
Lead		EPA 6010D / 3050B	<9.63	9.63	mg/kg	03/17/25	DB

All internal QC parameters were met. Unusual sample conditions, if any, are described. Surrogate Spike results designated with "D" indicate that the analyte was diluted out. "MI" indicates matrix interference. Concentration and *Reporting Limit (RL) based on areas provided by client. Values are reported to three significant figures. Solid PPM = mg/kg | PPB = µg/kg and Water PPM = mg/L | PPB = µg/L. The test results apply to the sample as received.



Customer: Washoe County School District (4991)
Address: 7495 S. Virginia Street
Reno, NV 89511

Order #:	611383
-----------------	--------

Matrix Paint
Received 03/17/25
Reported 03/20/25

Attn:

Project:

Location: 130 - Roy Gomm ES
Number:

PO Number: PO224939

Sample ID	Cust. Sample ID	Location	Result	RL*	Units	Analysis Date	Analyst
Parameter		Method					
611383-031	130PB-5069-15494	SE Play Structure-N Ctr					
Metals Analysis							
Lead		EPA 6010D / 3050B	<9.37	9.37	mg/kg	03/17/25	DB
611383-032	130PB-5069-15495	SE Play Structure-S/E End					
Metals Analysis							
Lead		EPA 6010D / 3050B	<9.88	9.87	mg/kg	03/18/25	DB
611383-033	130PB-5069-15496	SE Play Structure-S/W End					
Metals Analysis							
Lead		EPA 6010D / 3050B	<9.57	9.57	mg/kg	03/18/25	DB
611383-034	130PB-5069-15497	NW Bench					
Metals Analysis							
Lead		EPA 6010D / 3050B	<9.54	9.54	mg/kg	03/18/25	DB
611383-035	130PB-5069-15498	NE Bench					
Metals Analysis							
Lead		EPA 6010D / 3050B	<9.78	9.78	mg/kg	03/18/25	DB
611383-036	130PB-5069-15499	NE Bench					
Metals Analysis							
Lead		EPA 6010D / 3050B	<9.85	9.84	mg/kg	03/18/25	DB
611383-037	130PB-5069-15500	NE Bench					
Metals Analysis							
Lead		EPA 6010D / 3050B	<9.26	9.25	mg/kg	03/18/25	DB
611383-038	130PB-5069-15501	NE Bench					
Metals Analysis							
Lead		EPA 6010D / 3050B	<9.60	9.60	mg/kg	03/18/25	DB
611383-039	130PB-5069-15502	NW Bench					
Metals Analysis							
Lead		EPA 6010D / 3050B	<10.4	10.3	mg/kg	03/18/25	DB
611383-040	130PB-5069-15503	SW Play Structure-E Ctr					
Metals Analysis							
Lead		EPA 6010D / 3050B	<10.2	10.1	mg/kg	03/18/25	DB

All internal QC parameters were met. Unusual sample conditions, if any, are described. Surrogate Spike results designated with "D" indicate that the analyte was diluted out. "MI" indicates matrix interference. Concentration and *Reporting Limit (RL) based on areas provided by client. Values are reported to three significant figures. Solid PPM = mg/kg | PPB = µg/kg and Water PPM = mg/L | PPB = µg/L. The test results apply to the sample as received.



Analysis Report

Schneider Laboratories Global, Inc

2512 W. Cary Street • Richmond, Virginia • 23220-5117
804-353-6778 • 800-785-LABS (5227) • Fax 804-359-1475

Customer: Washoe County School District (4991)
Address: 7495 S. Virginia Street
Reno, NV 89511

Order #: 611383

Matrix: Paint
Received: 03/17/25
Reported: 03/20/25

Attn:
Project:
Location: 130 - Roy Gomm ES
Number:

PO Number: PO224939

Table with columns: Sample ID, Cust. Sample ID, Location, Parameter, Method, Result, RL*, Units, Analysis Date, Analyst. Contains 15 rows of lead analysis data for various locations like 'E Ctr Play Structure-SW', 'Jungle Gym-E Side Ctr', etc.

All internal QC parameters were met. Unusual sample conditions, if any, are described. Surrogate Spike results designated with "D" indicate that the analyte was diluted out. "MI" indicates matrix interference. Concentration and *Reporting Limit (RL) based on areas provided by client. Values are reported to three significant figures. Solid PPM = mg/kg | PPB = µg/kg and Water PPM = mg/L | PPB = µg/L. The test results apply to the sample as received.



Analysis Report

Schneider Laboratories Global, Inc

2512 W. Cary Street • Richmond, Virginia • 23220-5117
804-353-6778 • 800-785-LABS (5227) • Fax 804-359-1475

Customer: Washoe County School District (4991)
Address: 7495 S. Virginia Street
Reno, NV 89511

Order #: 611383

Matrix: Paint
Received: 03/17/25
Reported: 03/20/25

Attn:
Project:
Location: 130 - Roy Gomm ES
Number:

PO Number: PO224939

Table with columns: Sample ID, Cust. Sample ID, Location, Parameter, Method, Result, RL*, Units, Analysis Date, Analyst. Contains 18 rows of lead analysis data for various locations like N Play Structure-Ctr, S Table-NE Cnr, etc.

All internal QC parameters were met. Unusual sample conditions, if any, are described. Surrogate Spike results designated with "D" indicate that the analyte was diluted out. "MI" indicates matrix interference. Concentration and *Reporting Limit (RL) based on areas provided by client. Values are reported to three significant figures. Solid PPM = mg/kg | PPB = µg/kg and Water PPM = mg/L | PPB = µg/L. The test results apply to the sample as received.



Analysis Report

Schneider Laboratories Global, Inc

2512 W. Cary Street • Richmond, Virginia • 23220-5117
804-353-6778 • 800-785-LABS (5227) • Fax 804-359-1475

Customer: Washoe County School District (4991)
Address: 7495 S. Virginia Street
Reno, NV 89511

Order #:	611383
-----------------	--------

Matrix Paint
Received 03/17/25
Reported 03/20/25

Attn:

Project:

Location: 130 - Roy Gomm ES
Number:

PO Number: PO224939

Sample ID	Cust. Sample ID	Location	Result	RL*	Units	Analysis Date	Analyst
Parameter		Method					
611383-061	130PB-5069-15524	Fire Hydrant NV Map-N Ctr					
Metals Analysis							
Lead		EPA 6010D / 3050B	2700	94.5	mg/kg	03/18/25	DB
611383-062	130PB-5069-15525	Fire Hydrant NV Map-N Ctr					
Metals Analysis							
Lead		EPA 6010D / 3050B	3090	93.7	mg/kg	03/18/25	DB
611383-063	130PB-5069-15526	Fire Hydrant NV Map-N Ctr					
Metals Analysis							
Lead		EPA 6010D / 3050B	10400	486	mg/kg	03/18/25	DB
611383-064	130PB-5069-15527	S Ctr Play Structure-S/W					
Metals Analysis							
Lead		EPA 6010D / 3050B	<9.91	9.90	mg/kg	03/18/25	DB
611383-065	130PB-5069-15528	S Ctr Play Structure-N					
Metals Analysis							
Lead		EPA 6010D / 3050B	<9.85	9.84	mg/kg	03/18/25	DB
611383-066	130PB-5069-15529	S Ctr Play Structure-SE					
Metals Analysis							
Lead		EPA 6010D / 3050B	<9.07	9.06	mg/kg	03/18/25	DB
611383-067	130PB-5069-15530	E Ctr Play Structure-Ctr					
Metals Analysis							
Lead		EPA 6010D / 3050B	15.1	9.54	mg/kg	03/18/25	DB
611383-068	130PB-5069-15531	E Ctr Play Structure-E					
Metals Analysis							
Lead		EPA 6010D / 3050B	<9.72	9.72	mg/kg	03/18/25	DB
611383-069	130PB-5069-15532	E Ctr Play Structure-NE					
Metals Analysis							
Lead		EPA 6010D / 3050B	17.9	9.66	mg/kg	03/18/25	DB
611383-070	130PB-5069-15533	SW Play Structure-N/W End					
Metals Analysis							
Lead		EPA 6010D / 3050B	<9.15	9.14	mg/kg	03/18/25	DB

All internal QC parameters were met. Unusual sample conditions, if any, are described. Surrogate Spike results designated with "D" indicate that the analyte was diluted out. "MI" indicates matrix interference. Concentration and *Reporting Limit (RL) based on areas provided by client. Values are reported to three significant figures. Solid PPM = mg/kg | PPB = µg/kg and Water PPM = mg/L | PPB = µg/L. The test results apply to the sample as received.



Analysis Report

Schneider Laboratories Global, Inc

2512 W. Cary Street • Richmond, Virginia • 23220-5117
804-353-6778 • 800-785-LABS (5227) • Fax 804-359-1475

Customer: Washoe County School District (4991)
Address: 7495 S. Virginia Street
Reno, NV 89511

Order #:	611383
-----------------	--------

Matrix Paint
Received 03/17/25
Reported 03/20/25

Attn:

Project:

Location: 130 - Roy Gomm ES

Number:

PO Number: PO224939

Sample ID	Cust. Sample ID	Location	Result	RL*	Units	Analysis Date	Analyst
Parameter		Method					
611383-071	130PB-5069-15534	SW Play Structure-N Ctr					
Metals Analysis							
Lead		EPA 6010D / 3050B	<9.63	9.63	mg/kg	03/18/25	DB
611383-072	130PB-5069-15535	SW Play Structure-N/W End					
Metals Analysis							
Lead		EPA 6010D / 3050B	<9.29	9.28	mg/kg	03/18/25	DB

611383-03/20/25 04:06 PM

Reviewed By: **Kelly Muncy**
Manager

State Certifications

Method	Parameter	Nevada	Virginia
EPA 6010D	Lead	Not Certified	VELAP Certified
State	Certificate Number		
Virginia	VELAP 12761		

All internal QC parameters were met. Unusual sample conditions, if any, are described. Surrogate Spike results designated with "D" indicate that the analyte was diluted out. "MI" indicates matrix interference. Concentration and *Reporting Limit (RL) based on areas provided by client. Values are reported to three significant figures. Solid PPM = mg/kg | PPB = µg/kg and Water PPM = mg/L | PPB = µg/L. The test results apply to the sample as received.

Charge to C.C.

WCSD LEAD BULK SAMPLE CHAIN OF CUSTODY FORM

Requested By: John Nolan

Phone Number: 775-325-8491

Fax Number: 775-851-5662

Analysis Turn Around Time: Rush-Same Day, 1 Day, 2 Day, 3 Day, 5 Day

Instructions: Email results to the ESA Department. In addition, produce a separate report for each facility. A new prefix number on a sample identifies a new site. ACCT. #4991

Analysis Type: ICP

Date Sampled: 3/10/2025

Facility: 130 - Roy Gomm ES

<u>SAMPLE #</u>	<u>ITEM DESCRIPTION</u>	<u>SUBSTRATE</u>	<u>COLOR</u>	<u>ROOM</u>
130PB - 5069 - 15464	Nevada Map - NW Corner.	Asphalt	Light Blue	Exterior
130PB - 5069 - 15465	USA Map - S Side Center.	Asphalt	Light Blue	Exterior
130PB - 5069 - 15466	USA Map - SW Corner.	Asphalt	Light Blue	Exterior
130PB - 5069 - 15467	Nevada Map - NW Corner.	Asphalt	Blue	Exterior
130PB - 5069 - 15468	Nevada Map - NE Corner.	Asphalt	Blue	Exterior
130PB - 5069 - 15469	Nevada Map - NE Corner.	Asphalt	Blue	Exterior
130PB - 5069 - 15470	USA Map - NW Corner.	Asphalt	Brown	Exterior
130PB - 5069 - 15471	USA Map - NW Corner.	Asphalt	Brown	Exterior

SENT BY: Brian Priest

DATE/TIME: 3-12-25 11:38 AM

RECEIVED BY: ALAN J.

DATE/TIME: 3/17/25 7:25 AM

RECEIVED BY: _____

DATE/TIME: _____

RECEIVED BY: _____

DATE/TIME: _____

S 72

611383

V:\611\611383

ajackson
U.S. Mail

3/17/2025 7:25:10 AM

N/A

Charge to c.c.

WCSD LEAD BULK SAMPLE CHAIN OF CUSTODY FORM

Requested By: John Nolan

Phone Number: 775-325-8491

Fax Number: 775-851-5662

Analysis Turn Around Time: Rush-Same Day, 1 Day, 2 Day, 3 Day, 5 Day

Instructions: Email results to the ESA Department. In addition, produce a separate report for each facility. A new prefix number on a sample identifies a new site. ACCT. #4991

Analysis Type: ICP

Date Sampled:

3/10/2025

Facility: 130 - Roy Gomm ES

<u>SAMPLE #</u>	<u>ITEM DESCRIPTION</u>	<u>SUBSTRATE</u>	<u>COLOR</u>	<u>ROOM</u>
130PB - 5069 - 15472	USA Map - S Side Center.	Asphalt	Brown	Exterior
130PB - 5069 - 15473	USA Map - N of Center.	Asphalt	Green	Exterior
130PB - 5069 - 15474	USA Map - W Side Center.	Asphalt	Green	Exterior
130PB - 5069 - 15475	Nevada Map - E Side Center.	Asphalt	Green	Exterior
130PB - 5069 - 15476	Building D Play Area - W Side Center.	Asphalt	Seafoam Green	Exterior
130PB - 5069 - 15477	Building D Play Area - SE Corner.	Asphalt	Seafoam Green	Exterior
130PB - 5069 - 15478	Building D Play Area - W Side Center.	Asphalt	Seafoam Green	Exterior
130PB - 5069 - 15479	USA Map - Center.	Asphalt	Purple	Exterior

SENT BY: Brian Priest

DATE/TIME: 3-12-25 11:38AM

RECEIVED BY: ALAN J.

DATE/TIME: 3/17/25 7:25AM

RECEIVED BY: _____

DATE/TIME: _____

RECEIVED BY: _____

DATE/TIME: _____

Charge to C.C.

WCSD LEAD BULK SAMPLE CHAIN OF CUSTODY FORM

Requested By: John Nolan

Phone Number: 775-325-8491

Fax Number: 775-851-5662

Analysis Turn Around Time: Rush-Same Day, 1 Day, 2 Day, 3 Day, 5 Day

Instructions: Email results to the ESA Department. In addition, produce a separate report for each facility. A new prefix number on a sample identifies a new site. ACCT. #4991

Analysis Type: ICP

Date Sampled: 3/10/2025

Facility: 130 - Roy Gomm ES

<u>SAMPLE #</u>	<u>ITEM DESCRIPTION</u>	<u>SUBSTRATE</u>	<u>COLOR</u>	<u>ROOM</u>
130PB - 5069 - 15480	Nevada Map - E Side Center.	Asphalt	Purple	Exterior
130PB - 5069 - 15481	USA Map - E Side N End.	Asphalt	Purple	Exterior
130PB - 5069 - 15482	Nevada Map - SE Corner.	Asphalt	Red	Exterior
130PB - 5069 - 15483	USA Map - S Side Center.	Asphalt	Red	Exterior
130PB - 5069 - 15484	USA Map - S Side Center.	Asphalt	Red	Exterior
130PB - 5069 - 15485	USA Map - N Side Center.	Asphalt	White	Exterior
130PB - 5069 - 15486	Nevada Map - Center at Hydrant.	Asphalt	White	Exterior
130PB - 5069 - 15487	Nevada Map - E Side Center.	Asphalt	White	Exterior

SENT BY: Brian Priest

DATE/TIME: 3-12-25 11:38 AM

RECEIVED BY: ALAN J.

DATE/TIME: 3/12/25 7:25 AM

RECEIVED BY:

DATE/TIME:

RECEIVED BY:

DATE/TIME:

Charge to c.c.

WCSD LEAD BULK SAMPLE CHAIN OF CUSTODY FORM

Requested By: John Nolan

Phone Number: 775-325-8491

Fax Number: 775-851-5662

Analysis Turn Around Time: Rush-Same Day, 1 Day, 2 Day, 3 Day, 5 Day

Instructions: Email results to the ESA Department. In addition, produce a separate report for each facility. A new prefix number on a sample identifies a new site. ACCT. #4991

Analysis Type: ICP

Date Sampled: 3/10/2025

Facility: 130 - Roy Gomm ES

<u>SAMPLE #</u>	<u>ITEM DESCRIPTION</u>	<u>SUBSTRATE</u>	<u>COLOR</u>	<u>ROOM</u>
130PB - 5069 - 15488	USA Map - W Side Center.	Asphalt	Yellow	Exterior
130PB - 5069 - 15489	Nevada Map - Center.	Asphalt	Yellow	Exterior
130PB - 5069 - 15490	USA Map - E Side Center.	Asphalt	Yellow	Exterior
130PB - 5069 - 15491	Building D Play Area - N Side Center.	Asphalt	Bright Yellow	Exterior
130PB - 5069 - 15492	Building D Play Area - W of Center.	Asphalt	Bright Yellow	Exterior
130PB - 5069 - 15493	Building D Play Area - W Side Center.	Asphalt	Bright Yellow	Exterior
130PB - 5069 - 15494	SE Play Structure - N Side Center.	Metal - Pole	Black	Exterior
130PB - 5069 - 15495	SE Play Structure - S Side E End.	Metal - Pole	Black	Exterior

SENT BY: Brian Priest

DATE/TIME: 3-12-25 11:38 AM

RECEIVED BY: ALAN J.

DATE/TIME: 3/17/25 7:25 AM

RECEIVED BY: _____

DATE/TIME: _____

RECEIVED BY: _____

DATE/TIME: _____

Charge to C.C.

WCSD LEAD BULK SAMPLE CHAIN OF CUSTODY FORM

Requested By: John Nolan

Phone Number: 775-325-8491

Fax Number: 775-851-5662

Analysis Turn Around Time: Rush-Same Day, 1 Day, 2 Day, 3 Day, 5 Day

Instructions: Email results to the ESA Department. In addition, produce a separate report for each facility. A new prefix number on a sample identifies a new site. ACCT. #4991

Analysis Type: ICP

Date Sampled: 3/10/2025

Facility: 130 - Roy Gomm ES

<u>SAMPLE #</u>	<u>ITEM DESCRIPTION</u>	<u>SUBSTRATE</u>	<u>COLOR</u>	<u>ROOM</u>
130PB - 5069 - 15496	SE Play Structure - S Side W End.	Metal - Pole	Black	Exterior
130PB - 5069 - 15497	NW Bench.	Metal	Black	Exterior
130PB - 5069 - 15498	NE Bench.	Metal	Black	Exterior
130PB - 5069 - 15499	NE Bench.	Metal	Black	Exterior
130PB - 5069 - 15500	NE Bench.	Metal	Blue	Exterior
130PB - 5069 - 15501	NE Bench.	Metal	Blue	Exterior
130PB - 5069 - 15502	NW Bench.	Metal	Blue	Exterior
130PB - 5069 - 15503	SW Play Structure - E Side Center.	Metal - Pole	Blue	Exterior

SENT BY: Brian Priest

DATE/TIME: 3-12-25 11:38 AM

RECEIVED BY: FRANK J

DATE/TIME: 3/17/25 7:25 AM

RECEIVED BY: _____

DATE/TIME: _____

RECEIVED BY: _____

DATE/TIME: _____

Charge to C.C.

WCSD LEAD BULK SAMPLE CHAIN OF CUSTODY FORM

Requested By: John Nolan

Phone Number: 775-325-8491

Fax Number: 775-851-5662

Analysis Turn Around Time: Rush-Same Day, 1 Day, 2 Day, 3 Day, 5 Day

Instructions: Email results to the ESA Department. In addition, produce a separate report for each facility. A new prefix number on a sample identifies a new site. ACCT. #4991

Analysis Type: ICP Date Sampled: 3/10/2025 Facility: 130 - Roy Gomm ES

<u>SAMPLE #</u>	<u>ITEM DESCRIPTION</u>	<u>SUBSTRATE</u>	<u>COLOR</u>	<u>ROOM</u>
130PB - 5069 - 15504	E Center Play Structure - SW Corner.	Metal - Pole	Blue	Exterior
130PB - 5069 - 15505	Jungle Gym - E Side Center.	Metal - Pole	Blue	Exterior
130PB - 5069 - 15506	NW Swing Set - N Side Center.	Metal - Pole	Blue	Exterior
130PB - 5069 - 15507	E Swing Set - SW Corner.	Metal - Pole	Blue	Exterior
130PB - 5069 - 15508	E Swing Set - SE Corner.	Metal - Pole	Blue	Exterior
130PB - 5069 - 15509	SE Play Structure - W Side Center.	Metal - Pole	Green	Exterior
130PB - 5069 - 15510	SE Play Structure - E Side Center.	Metal - Pole	Green	Exterior
130PB - 5069 - 15511	SE Play Structure - Center.	Metal - Pole	Green	Exterior

SENT BY: Brian Priest

DATE/TIME: 3-12-25 11:38 AM

RECEIVED BY: ALAN J.

DATE/TIME: 3/17/25 7:25 AM

RECEIVED BY: _____

DATE/TIME: _____

RECEIVED BY: _____

DATE/TIME: _____

Charge to C.C.

WCSD LEAD BULK SAMPLE CHAIN OF CUSTODY FORM

Requested By: John Nolan

Phone Number: 775-325-8491

Fax Number: 775-851-5662

Analysis Turn Around Time: Rush-Same Day, 1 Day, 2 Day, 3 Day, 5 Day

Instructions: Email results to the ESA Department. In addition, produce a separate report for each facility. A new prefix number on a sample identifies a new site. ACCT. #4991

Analysis Type: ICP

Date Sampled: 3/10/2025

Facility: 130 - Roy Gomm ES

<u>SAMPLE #</u>	<u>ITEM DESCRIPTION</u>	<u>SUBSTRATE</u>	<u>COLOR</u>	<u>ROOM</u>
130PB - 5069 - 15512	N Play Structure - NW Corner.	Metal - Post	Kelly Green	Exterior
130PB - 5069 - 15513	N Play Structure - SE Corner.	Metal - Post	Kelly Green	Exterior
130PB - 5069 - 15514	N Play Structure - Center.	Metal - Post	Kelly Green	Exterior
130PB - 5069 - 15515	S Table - NE Corner.	Metal	Orange	Exterior
130PB - 5069 - 15516	S Table - SW Corner.	Metal	Orange	Exterior
130PB - 5069 - 15517	N Table - NW Corner.	Metal	Orange	Exterior
130PB - 5069 - 15518	SW Play Structure - Center.	Metal - Pole	Burnt Orange	Exterior
130PB - 5069 - 15519	SW Play Structure - S Side Center.	Metal - Pole	Burnt Orange	Exterior

SENT BY: Brian Priest

DATE/TIME: 3-12-25 11:38:44

RECEIVED BY: ALAN E J.

DATE/TIME: 3/17/25 7:25 AM

RECEIVED BY: _____

DATE/TIME: _____

RECEIVED BY: _____

DATE/TIME: _____

Charge to C.C.

WCSD LEAD BULK SAMPLE CHAIN OF CUSTODY FORM

Requested By: John Nolan

Phone Number: 775-325-8491

Fax Number: 775-851-5662

Analysis Turn Around Time: Rush-Same Day, 1 Day, 2 Day, 3 Day, 5 Day

Instructions: Email results to the ESA Department. In addition, produce a separate report for each facility. A new prefix number on a sample identifies a new site. ACCT. #4991

Analysis Type: ICP

Date Sampled: 3/10/2025

Facility: 130 - Roy Gomm ES

<u>SAMPLE #</u>	<u>ITEM DESCRIPTION</u>	<u>SUBSTRATE</u>	<u>COLOR</u>	<u>ROOM</u>
130PB - 5069 - 15520	SW Play Structure - SW Corner.	Metal - Pole	Burnt Orange	Exterior
130PB - 5069 - 15521	SE Tetherball Poles - S Pole.	Metal - Pole	Red	Exterior
130PB - 5069 - 15522	SE Tetherball Poles - N Pole.	Metal - Pole	Red	Exterior
130PB - 5069 - 15523	SE Tetherball Poles - S Pole.	Metal - Pole	Red	Exterior
130PB - 5069 - 15524	Fire Hydrant in Nevada Map - N Side Center.	Metal - Fire Hydrant	Red	Exterior
130PB - 5069 - 15525	Fire Hydrant in Nevada Map - N Side Center.	Metal - Fire Hydrant	Red	Exterior
130PB - 5069 - 15526	Fire Hydrant in Nevada Map - N Side Center.	Metal - Fire Hydrant	Red	Exterior
130PB - 5069 - 15527	South Of Center Play Structure - S Side W End.	Metal - Pole	White	Exterior

SENT BY: Brian Priest

DATE/TIME: 3-12-25 11:38 AM

RECEIVED BY: ALAN J.

DATE/TIME: 3/17/25 7:25 AM

RECEIVED BY: _____

DATE/TIME: _____

RECEIVED BY: _____

DATE/TIME: _____

Charge to C.C.

WCSD LEAD BULK SAMPLE CHAIN OF CUSTODY FORM

Requested By: John Nolan

Phone Number: 775-325-8491

Fax Number: 775-851-5662

Analysis Turn Around Time: Rush-Same Day, 1 Day, 2 Day, 3 Day, 5 Day

Instructions: Email results to the ESA Department. In addition, produce a separate report for each facility. A new prefix number on a sample identifies a new site. ACCT. #4991

Analysis Type: ICP Date Sampled: 3/10/2025 Facility: 130 - Roy Gomm ES

<u>SAMPLE #</u>	<u>ITEM DESCRIPTION</u>	<u>SUBSTRATE</u>	<u>COLOR</u>	<u>ROOM</u>
130PB - 5069 - 15528	South Of Center Play Structure - N side center.	Metal - Pole	White	Exterior
130PB - 5069 - 15529	South Of Center Play Structure - SE Corner.	Metal - Pole	White	Exterior
130PB - 5069 - 15530	E Center Play Structure - Center.	Metal - Pole	Yellow	Exterior
130PB - 5069 - 15531	E Center Play Structure - E Side Center.	Metal - Pole	Yellow	Exterior
130PB - 5069 - 15532	E Center Play Structure - NE Corner On Spiral Pole	Metal - Pole	Yellow	Exterior
130PB - 5069 - 15533	SW Play Structure - N Side W End.	Metal - Pole	Dusty Yellow	Exterior
130PB - 5069 - 15534	SW Play Structure - N Side Center.	Metal - Pole	Dusty Yellow	Exterior
130PB - 5069 - 15535	SW Play Structure - N Side W End.	Metal - Pole	Dusty Yellow	Exterior

SENT BY: Brian Priest

RECEIVED BY: ALAN J.

RECEIVED BY: _____

RECEIVED BY: _____

DATE/TIME: 3-12-25 11:38 AM

DATE/TIME: 3/17/25 7:25 AM

DATE/TIME: _____

DATE/TIME: _____

Appendix C

Site Photos and Sample Location Drawings



Asphalt Patch



Concrete Sidewalks



Concrete Fence Footings



Concrete Playground Footings
Red Paint on Metal Tetherball Poles



Blue Paint on Metal Swing Set



Red Paint on Concrete Curb



Blue & Black Paints on Metal Benches



Yellow & Blue Paints on Metal Play Structure



Blue Vinyl Coating



Black Vinyl Coating



White & Blue Paints on Metal Play Structure



Red Vinyl Coating



Concrete Valley Gutters



Orange Paint on Metal Table



Dark Brown Vinyl Coating
Green & Black Paints on Metal Play Structure



Burnt Orange & Dusty Yellow Paints
on Metal Play Structure



Kelly Green Paint on Metal Play Structure



Light Blue Paint on Asphalt Lot



Bright Yellow Paint on Asphalt Lot



Seafoam Green Paint on Asphalt Lot



Purple, Brown, Red, White, Yellow, & Blue Paints on Asphalt Lot



Blue Paint on Metal Jungle Gym



Blue Paint on Metal Play Structure



Blue & Burnt Orange Paints on Metal Play Structure

Roof Section	Size (Sq. Ft.)	Roof System	Roof Membrane	Year Installed	Manufacturer	Mfgr Warranty Expires	Mfgr Warranty Phone	Contractor	Contractor Warranty Expires	Contractor Warranty Phone	Estimated Replacement
A & B (East & Center Buildings and Walkway)	24,874	Modified Bitumen	SBS Modified	2001	Johns Manville	08/20/2011	(800) 922-5922	Cedar Roofing	-	-	6-10 years
C (West Building)	16,128	Modified Bitumen	SBS modified bitumen	1991	GAF Materials Corporation	07/31/2025	(800) 766-3411	D&D Roofing and Sheet Metal, Inc.	07/31/2017	(775) 685-5555	11+ years
D1 (North Building - Lower Roof)	3,904	Modified Bitumen	Modified bitumen	2009	GAF Materials Corporation	08/17/2009	(800) 766-3411	Kodiak Roofing	08/14/2009	(915) 253-1900	11+ years
D2 (North Building - Upper Roof)	3,661	Modified Bitumen	Modified bitumen	2009	GAF Materials Corporation	08/17/2009	(800) 766-3411	Kodiak Roofing	08/14/2009	(915) 253-1900	11+ years
E (Single Point Entry Corrugated Metal Panel Roof)	336	Architectural Metal Panel	Prefinished aluminum	2013	Unknown	-	-	-	-	-	11+ years

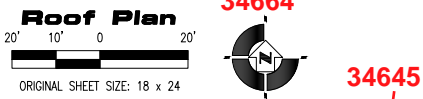
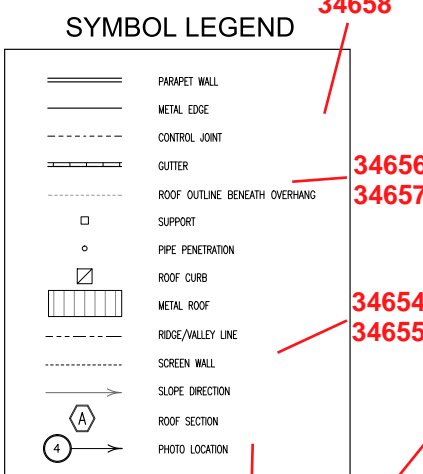
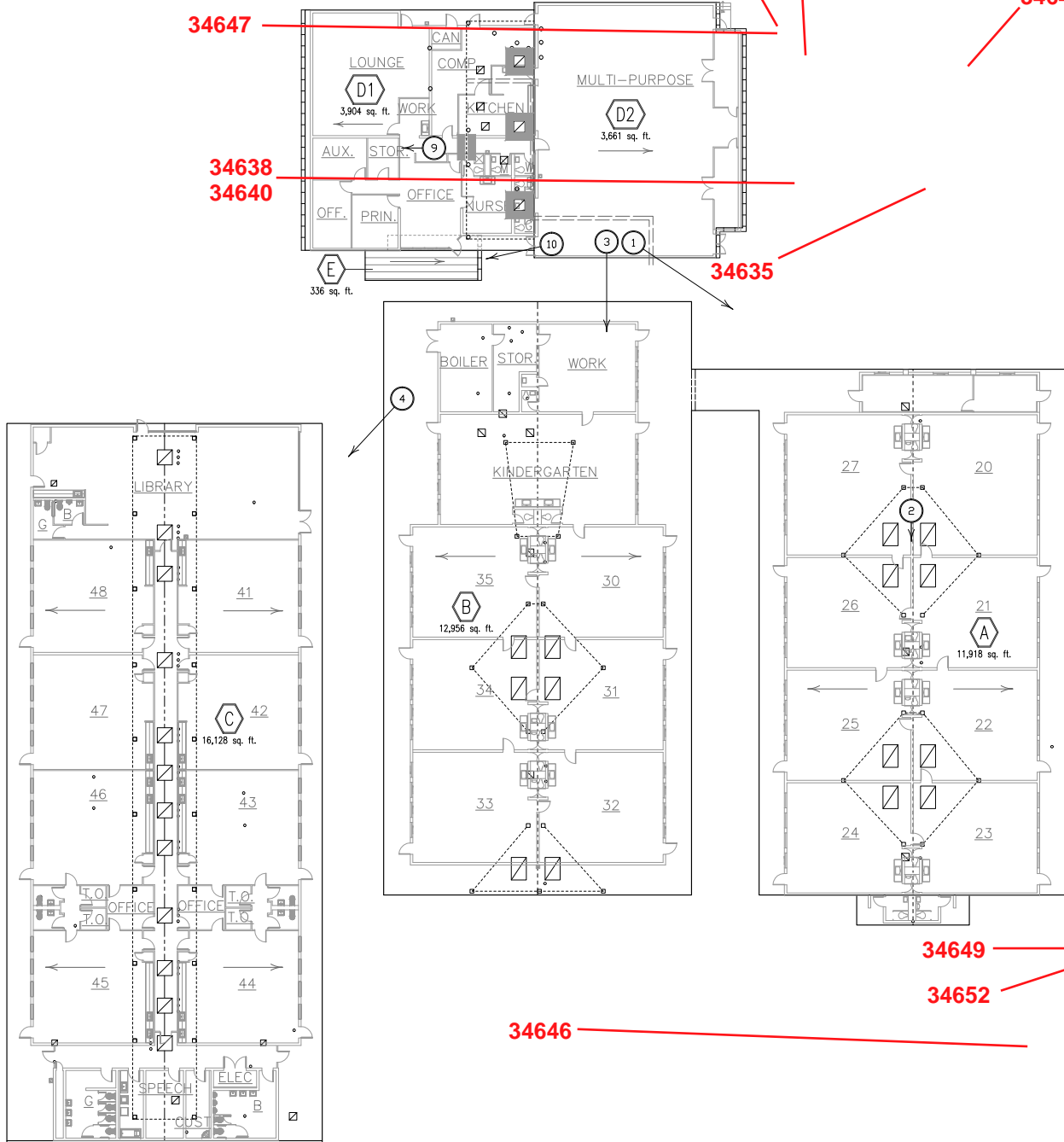

2015 Construction Update Plan

WASHOE COUNTY SCHOOL DISTRICT
 130-ROY GOMM ELEMENTARY SCHOOL
 4000 MAYBERRY DRIVE
 RENO, NEVADA

Benchmark CONSULTING INC.
 CEDAR RAPIDS, IA • WALKESHA, WI
 Phone: 319.393.9100
 www.benchmark-inc.com

MANAGER: T. WILLMAN
 DRAWN BY: M. WILSON
 DATE: 12/12/15
 JOB NO.: WASREN0219A
 DRAWING NO.: WASREN0219A003

REVISIONS:
 REV. NO. DATE BY: SENIOR
 REV. NO. DATE BY: DRAFTING

SHEET: R-1

File: C:\Temp\Ac-Publisher_5472\WASREN0219A003.dwg Time: Dec 15, 2015 8:27am

34659,34660,34661

Roof Section	Size (Sq. Ft.)	Roof System	Roof Membrane	Year Installed	Manufacturer	Mfgr Warranty Expires	Mfgr Warranty Phone	Contractor	Contractor Warranty Expires	Contractor Warranty Phone	Estimated Replacement
A & B (East & Center Buildings and Walkway)	24,874	Modified Bitumen	SBS Modified	2001	Johns Manville	08/20/2011	(800) 922-5922	Cedar Roofing	-	-	6-10 years
C (West Building)	16,128	Modified Bitumen	SBS modified bitumen	1991	GAF Materials Corporation	07/31/2025	(800) 766-3411	D&D Roofing and Sheet Metal, Inc.	07/31/2011	(775) 685-5555	11+ years
D1 (North Building - Lower Roof)	3,904	Modified Bitumen	Modified bitumen	2009	GAF Materials Corporation	08/17/2009	(800) 766-3411	Kodiak Roofing	08/14/2009	(915) 253-1900	11+ years
D2 (North Building - Upper Roof)	3,661	Modified Bitumen	Modified bitumen	2009	GAF Materials Corporation	08/17/2009	(800) 766-3411	Kodiak Roofing	08/14/2009	(915) 253-1900	11+ years
E (Single Point Entry Corrugated Metal Panel Roof)	336	Architectural Metal Panel	Prefinished aluminum	2013	Unknown	-	-	-	-	-	11+ years

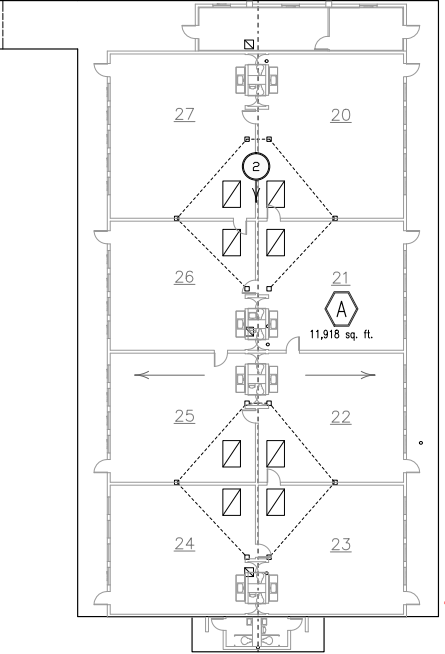
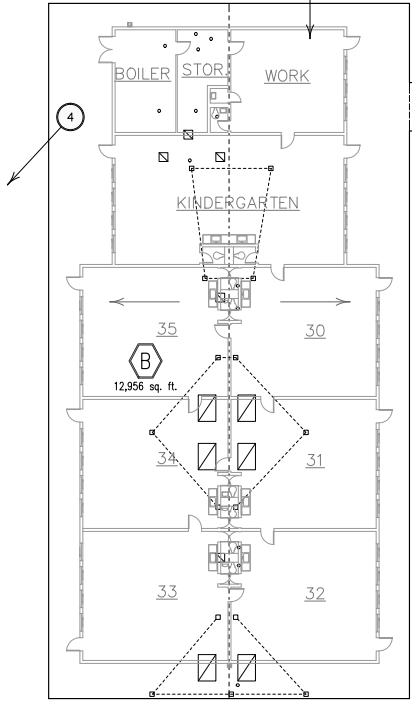
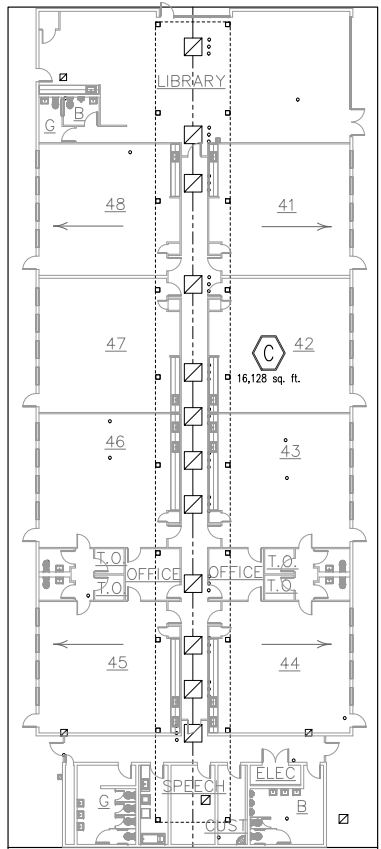
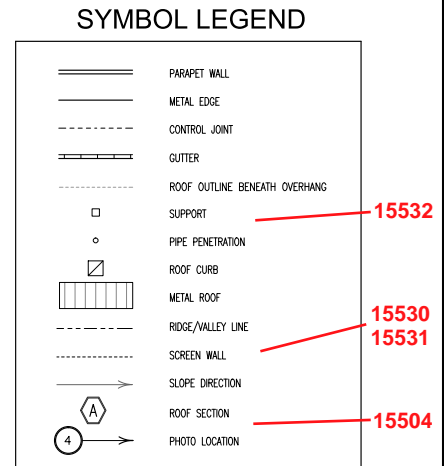
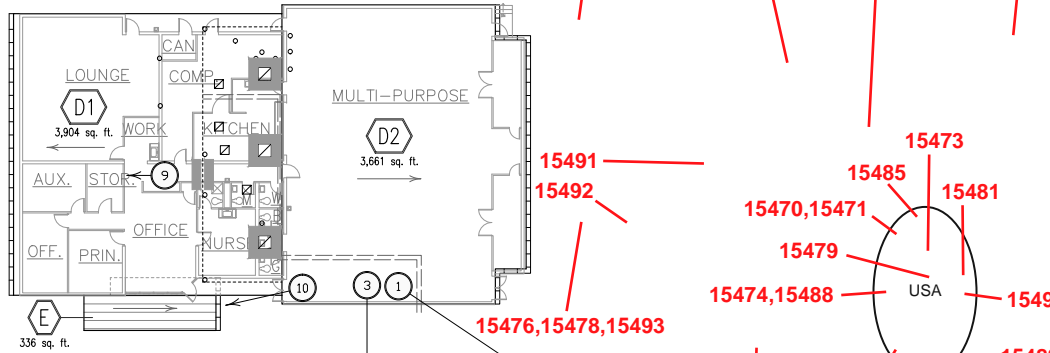

Roof Plan
 20' 10' 0' 20'
 ORIGINAL SHEET SIZE: 18 x 24

2015 Construction Update Plan
WASHOE COUNTY SCHOOL DISTRICT
 130-ROY GOMM ELEMENTARY SCHOOL
 4000 MAYBERRY DRIVE
 RENO, NEVADA

Benchmark
 CEDAR RAPIDS, IA • WAUKESHA, WI
 Phone: 319.393.9100
 www.benchmark-nc.com

MANAGER: T. WILLMAN
 DRAWN BY: M. WILSON
 DATE: 12/12/15
 JOB NO.: WASREN0219A
 DRAWING NO.: WASREN0219A003

REV. NO. DATE BY: SENIOR
 REV. NO. DATE BY: DRAFTING

SHEET: R-1

File: C:\Temp\Ac-Publisher_5472\WASREN0219A003.dwg Time: Dec 15, 2015 8:27am

Appendix D

Certifications of Personnel and Laboratories

STATE OF NEVADA
DEPARTMENT OF BUSINESS AND INDUSTRY
DIVISION OF INDUSTRIAL RELATIONS
Occupational Safety and Health Administration
Asbestos Control Program

Certifies That Daniel Prado
Forensic Analytical Consulting Services
is Licensed As Asbestos Abatement Consultant

License No. IJPM-2057 Expiration Date 09/05/2025

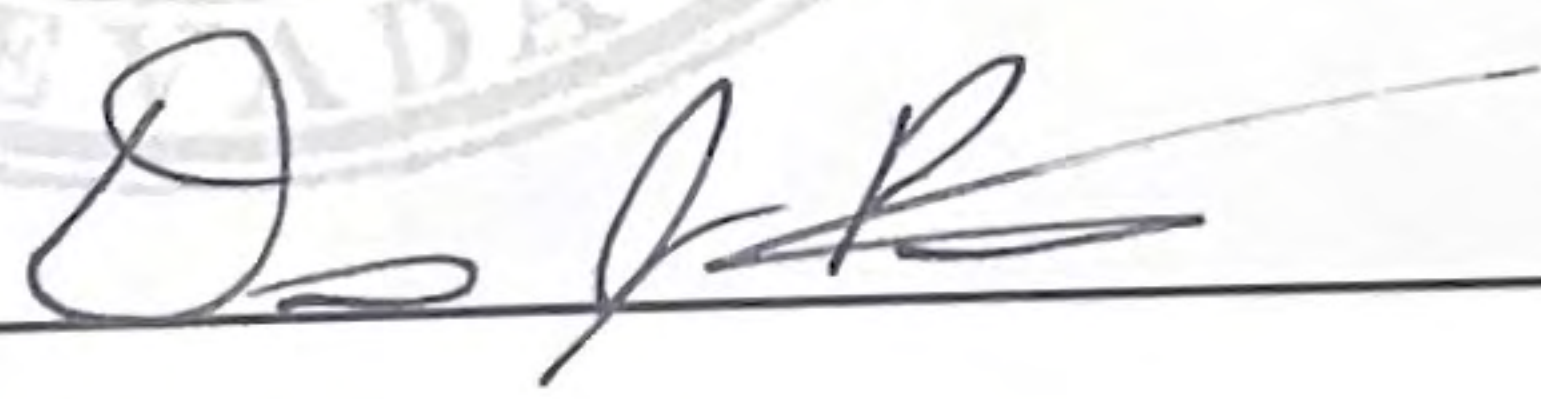
Signature Of Licensee 

Forensic Analytical Consulting Services, Inc.

This is to confirm that
Daniel Prado

Has attended the Four hour

AHERA Refresher Course for Asbestos Inspectors

And has completed the requisite training for asbestos accreditation under TSCA Title II

Course Date: 09-05-2024 to 09-05-2024

Certificate Number: PETBIR20240091

Valid Until: September 05, 2025

Cal/OSHA Approval Number: CA-025-06



Fred J. Vinciguerra, Chief Executive Officer
Forensic Analytical Consulting Services, Inc.
21228 Cabot Blvd, Hayward, CA 94545
(800) 677-1483

United States Environmental Protection Agency

This is to certify that



Daniel J Prado

has fulfilled the requirements of the Toxic Substances Control Act (TSCA) Section 402, and has received certification to conduct lead-based paint activities pursuant to 40 CFR Part 745.226 as:

Risk Assessor

In the Jurisdiction of:

All EPA Administered Lead-based Paint Activities Program States, Tribes and Territories

This certification is valid from the date of issuance and expires May 01, 2026

LBP-R-I214705-2

Certification #

February 28, 2023

Issued On

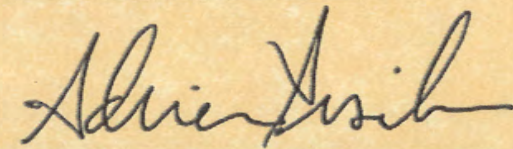

Adrienne Priselac, Manager, Toxics Office

Land Division

mm

STATE OF NEVADA
DEPARTMENT OF BUSINESS AND INDUSTRY
DIVISION OF INDUSTRIAL RELATIONS
Occupational Safety and Health Administration
Asbestos Control Program

Certifies That Zachary Ramos
Forensic Analytical Consulting Services
is Licensed As Asbestos Abatement Consultant

License No. IJM-2341 Expiration Date 04/19/2025

Signature Of Licensee _____

Zachary Ramos

Forensic Analytical Consulting Services, Inc.

This is to confirm that
Zachary Ramos

Has attended the Four hour

AHERA Refresher Course for Asbestos Inspectors

And has completed the requisite training for asbestos accreditation under TSCA Title II

Course Date: 09-05-2024 to 09-05-2024

Certificate Number: PETBIR20240100

Valid Until: September 05, 2025

Cal/OSHA Approval Number: CA-025-06



Fred J. Vinciguerra, Chief Executive Officer
Forensic Analytical Consulting Services, Inc.
21228 Cabot Blvd, Hayward, CA 94545
(800) 677-1483

United States Environmental Protection Agency

This is to certify that



Zachary E Ramos

has fulfilled the requirements of the Toxic Substances Control Act (TSCA) Section 402, and has received certification to conduct lead-based paint activities pursuant to 40 CFR Part 745.226 as:

Inspector

In the Jurisdiction of:

All EPA Administered Lead-based Paint Activities Program States, Tribes and Territories

This certification is valid from the date of issuance and expires November 01, 2026

LBP-I-I255969-1

Certification #

October 18, 2023

Issued On



A handwritten signature in black ink, appearing to read "Adrienne Priselac".

Adrienne Priselac, Manager, Toxics Office

Land Division

mm

STATE OF NEVADA
DEPARTMENT OF BUSINESS AND INDUSTRY
DIVISION OF INDUSTRIAL RELATIONS
Occupational Safety and Health Administration
Asbestos Control Program

Certifies That Danny Erickson
Forensic Analytical Consulting Services
is Licensed As Asbestos Abatement Consultant

License No. IJM-1135

Expiration Date 09/05/2025

Signature Of Licensee _____

Danny Erickson

Forensic Analytical Consulting Services, Inc.

This is to confirm that

Danny Erickson

Has attended the Four hour

AHERA Refresher Course for Asbestos Inspectors

And has completed the requisite training for asbestos accreditation under TSCA Title II

Course Date: 09-05-2024 to 09-05-2024

Certificate Number: PETBIR20240092

Valid Until: September 05, 2025

Cal/OSHA Approval Number: CA-025-06



A handwritten signature in black ink, appearing to read "Fred J. Vinciguerra", is written over a horizontal line.

Fred J. Vinciguerra, Chief Executive Officer
Forensic Analytical Consulting Services, Inc.
21228 Cabot Blvd, Hayward, CA 94545
(800) 677-1483

United States Environmental Protection Agency

This is to certify that



Danny R Erickson

has fulfilled the requirements of the Toxic Substances Control Act (TSCA) Section 402, and has received certification to conduct lead-based paint activities pursuant to 40 CFR Part 745.226 as:

Risk Assessor

In the Jurisdiction of:

All EPA Administered Lead-based Paint Activities Program States, Tribes and Territories

This certification is valid from the date of issuance and expires May 30, 2027

LBP-R-I184775-3

Certification #

March 01, 2024

Issued On



A handwritten signature in black ink, appearing to read "Adrienne Priselac". The signature is written in a cursive, flowing style.

Adrienne Priselac, Manager, Toxics Office

Land Division

United States Department of Commerce
National Institute of Standards and Technology



Certificate of Accreditation to ISO/IEC 17025:2017

NVLAP LAB CODE: 101150-0

Schneider Laboratories Global, Inc.
Richmond, VA

*is accredited by the National Voluntary Laboratory Accreditation Program for specific services,
listed on the Scope of Accreditation, for:*

Asbestos Fiber Analysis

*This laboratory is accredited in accordance with the recognized International Standard ISO/IEC 17025:2017.
This accreditation demonstrates technical competence for a defined scope and the operation of a laboratory quality
management system (refer to joint ISO-ILAC-IAF Communique dated January 2009).*

2024-04-01 through 2025-03-31

Effective Dates



A handwritten signature in blue ink, appearing to read 'Dana S. Gorman'.

For the National Voluntary Laboratory Accreditation Program



AIHA Laboratory Accreditation Programs, LLC

acknowledges that

Schneider Laboratories Global

2512 West Cary Street, Richmond, VA 23220-5117

Laboratory ID: LAP-100527

along with all premises from which key activities are performed, as listed above, has fulfilled the requirements of the AIHA Laboratory Accreditation Programs, LLC (AIHA LAP) accreditation to the ISO/IEC 17025:2017 international standard, General Requirements for the Competence of Testing and Calibration Laboratories in the following:

LABORATORY ACCREDITATION PROGRAMS

<input checked="" type="checkbox"/>	INDUSTRIAL HYGIENE	Accreditation Expires: August 01, 2025
<input checked="" type="checkbox"/>	ENVIRONMENTAL LEAD	Accreditation Expires: August 01, 2025
<input checked="" type="checkbox"/>	ENVIRONMENTAL MICROBIOLOGY	Accreditation Expires: August 01, 2025
<input type="checkbox"/>	FOOD	Accreditation Expires:
<input type="checkbox"/>	UNIQUE SCOPES	Accreditation Expires:
<input type="checkbox"/>	BERYLLIUM FIELD/MOBILE	Accreditation Expires:

Specific Field(s) of Testing/Method(s) within each Accreditation Program for which the above named laboratory maintains accreditation is outlined on the attached Scope of Accreditation. Continued accreditation is contingent upon successful on-going compliance with ISO/IEC 17025:2017 and AIHA LAP requirements. This certificate is not valid without the attached Scope of Accreditation. Please review the AIHA LAP website (www.aihaaccreditedlabs.org) for the most current Scope.

A handwritten signature in cursive script that reads 'Cheryl O. Morton'.

Cheryl O Morton
Managing Director, AIHA Laboratory Accreditation Programs, LLC

**Right People
Right Perspective
Right Now**

www.forensicanalytical.com



Hazardous Materials Specifications

Gomm Elementary School Site Drainage Project

4000 Mayberry Drive
Reno, NV 89519

Prepared for:

Washoe County School District Capital Projects

Created By:

Daniel Prado, FACS
IJPM-2057, US EPA LBP-R-I214705-2

Reviewed By:

Chris Chipponeri, FACS
IJPM-1410, US EP LBP-R-128230-3

Table of Contents

Site Address	1
Scope of Work.....	1
Project Requirements	2
Water, HVAC, and Electricity	3
Notifications.....	3
Equipment.....	3
Training	3
Personal Protection Equipment.....	4
Personal Air Monitoring.....	4
Security and Safety	4
Occupancy.....	5
Challenge Testing.....	5
Decontamination Requirements	5
Regulated Area Signage	5
Containment and Disturbance Procedure Requirements – Lead Component Removal.....	6
Disposal Requirements	7
Clearance	7

Site Address

Gomm Elementary School
4000 Mayberry Drive
Reno, NV 89519

Background

Washoe County School District (WCSD) will be performing a site drainage project on the eastern portion of their Gomm Elementary School campus. This project will involve the removal and replacement of various play structures, tables, concrete pads, and other fixtures as indicated on project drawings and other contract documents. Removal of a portion of the painted components will require the handling of lead-containing paints and for work to be performed in a lead-safe fashion by appropriately trained workers. Work does not have to be completed by a remediation contractor specifically, but all aspects of these specifications will be required to be met for the project by the contractor performing the lead paint aspect of work.

Scope of Work

In general, the contractor will be responsible for the removal of all components coated with lead-containing paints on the materials to be removed as part of the project.

The following paints were found to be **lead-containing** in the project area during a recent site survey conducted by Forensic Analytical Consulting Services (FACS):

- Yellow Paint on Metal Play Structure

The following paints were found to **not** contain lead during the recent FACS site survey:

- Orange Paint on Metal Tables
- Red Paint on Metal Tetherball Poles
- Blue Paint on Metal Play Structure

It should be noted that there are lead-containing and lead-based painted components directly adjacent to the planned project area. In the event the project scope expands beyond the known project area, the impacts to these paints will be re-evaluated.

Work involving the lead-containing paints triggers Federal OSHA requirements. Since none of the paints to be impacted were found to be lead-based, the US EPA Renovation, Repair, and Painting rule will not apply to this project.

None of the materials to be disturbed were found to contain asbestos.

The general contractor, and any sub-contractors working onsite, will need to consult the WCSD ES&A Department's Material Disturbance Permit to verify if material contains asbestos or lead prior to impacting any materials. Testing of materials not previously sampled or testing to verify asbestos or lead content of materials, will only be performed by WCSD ES&A Staff or District's independent third-party consultant. Testing by another third-party consultant will not be accepted as proof of the lead-content of paints or coatings.

Project Requirements

Contractors disturbing lead-containing paints shall be approved by the WCSD ES&A Department to perform lead activities within the District. **Approval of firms that have not previously performed activities impacting lead paints or coatings for the District will require submission for approval of all necessary documentation outlined by WCSD for the project at least fifteen (15) business days prior to work commencing.** This firm approval requirement extends to contractors that will be performing any work impacting lead-containing paints, even if that firm is not primarily a lead remediation contractor.

All worker certifications (lead training) shall be submitted for approval to the WCSD ES&A Department and all worker medical exams and fit tests shall be submitted to the District's onsite independent third-party consultant at least fifteen (15) working days prior to project commencement. Online training of employees is insufficient to meet the requirements of District policy and all training must be provided in-person, with each individual receiving a lead training certificate from the training provider. Contractor is responsible for reviewing WCSD ES&A worker roster for the company to ensure all workers to be used on the project have been approved prior to arrival onsite. Workers not identified on the approved WCSD ES&A worker list for the Contractor will not be allowed to perform any activities onsite, even if documentation is provided onsite at the time of the project commencement or worker arrival onsite.

The contractor performing remediation work will be responsible for following all plan requirements for materials/components to be removed. Neither WCSD personnel, nor any independent consultant providing project oversight, will be responsible for identifying materials or components to be removed as part of this contract. The Contractor's onsite supervisor shall have a copy of these Specifications onsite at all times and shall be familiar with the project requirements prior to arrival onsite at the project. Failure to follow requirements of these Specifications, or lack of knowledge of requirements to be followed during the project, are grounds for replacement of the remediation contractor's onsite supervisor.

No work impacting hazardous materials shall be performed during school hours or when staff and students are present at the school or in adjacent exterior areas of the school. Potential conflicts could include after-school programs that utilize the playground areas adjacent to the planned project area. Contractor will need to provide a detailed schedule, including work shift hours and days, for the work to be completed if work is to take place during the school year.

Only the remediation contractor will be allowed to occupy the project area once lead remediation activities are scheduled to start. This applies to all WCSD non-ES&A staff/personnel, general contractor, and other sub-contractors. The area shall only be occupied by the remediation contractor, WCSD ES&A staff, and District's independent third-party hazardous materials consultant.

Contractor shall adhere to the requirements of these Specifications, WCSD ES&A Lead Appendix (found in Material Disturbance Permit), and Federal, State and local regulations.

Water, HVAC, and Electricity

Water and electricity are available onsite; however, long hoses and cords may be necessary. Contractor shall provide a GFCI at the primary plug-in of all electrical trains used for electrical equipment. Hose washers shall be provided at all connections to prevent leakage of water and potential damage to District facilities. Contractor is responsible for any damage caused by their usage to any District water or electrical systems.

It is not anticipated that any HVAC systems will be within the project area. However, if HVAC systems are present the contractor shall coordinate with the WCSD Project Manager for the shut-down of any HVAC systems within the project area prior to commencing lead activities. Contractor is responsible for the lock-out / tag-out of all electrical circuits and HVAC systems that may be impacted by the project. Contractor shall follow requirements of WCSD for the lock-out / tag-out of equipment.

Notifications

No notifications are required to be filed with regulatory agencies for expected lead work activities; however, any contractor performing removal of lead-containing materials shall provide at least 48-hour notice to the District's independent third-party consultant, including setup / mobilization to the site.

Equipment

Contractor is responsible for providing all necessary equipment in sufficient quantities to complete the work in the schedule provided for the project. All equipment must arrive onsite clean and in proper functioning order. This includes HEPA-vacuums having new vacuum bags, negative air machines with new pre-filters, etc.

Any equipment that arrives onsite dirty or not in proper functioning order shall be removed from the project site for cleaning and/or repairs. If the equipment is provided by a rental agency, the contractor is required to provide a signed statement from the rental agency that states they acknowledge the equipment will be used within a lead work area.

Training

Workers performing work impacting lead paints or coatings, regardless of level of lead present and amount of disturbance, must have OSHA Lead Action Level training.

As noted previously, all worker certifications must be approved by WCSD ES&A prior to arrival onsite to start work. Copies of the worker certifications may be requested to be provided to the District's onsite third-party consultant as well. The lead training certificates must state training as "OSHA Action Level" and have the employee's complete name(s).

Failure to meet this requirement may cause a delay in approval of certifications up to full rejection of the training certificates. Web-based or virtual lead action level training is prohibited unless modified by other contractual documents or District-policy.

Personal Protection Equipment

All personnel entering a regulated area, regardless of level of work to be performed, shall wear disposable coveralls, tight-fitting half-face negative-pressure air purifying respirators fitted with HEPA (P-100) filters, safety glasses and gloves. The contractor may require additional personal protection equipment based on their job hazard assessment, but the listed requirements must be met at minimum.

Street clothes may be worn beneath disposable coveralls for lead activities, but street clothes will be HEPA-vacuumed clean if coveralls are torn or ripped. Requirements of PPE extend to any contractors disturbing hazardous materials, even if they are not primarily a remediation contractor.

All employees shall have a valid medical clearance and fit test for the respirators to be worn. Copies of the medical clearance and fit test shall be provided to the District's onsite independent third-party consultant.

Personal Air Monitoring

The contractor is responsible for the collection of personal air samples on 50% of workers entering a regulated work area during lead disturbance activities as applicable. If an odd number of workers are entering the regulated work area, the contractor shall round up for the number of workers to be monitored (i.e., five workers entering a work area would require collection of three samples). These samples shall be collected in accordance with OSHA sampling protocols and analyzed by a laboratory with the proper accreditation and approval from the WCSD ES&A Department.

The contractor shall have their laboratory submit or fax, within **48 hours** of the date the sample was collected, the final laboratory result documents (including legible chain-of-custody) for air monitoring to the WCSD ES&A Department. No handwritten results reports will be allowed. The laboratory reports will reference the air monitoring cassette's factory assigned number and the personal air monitoring results must be properly applied to an 8-hour time weighted average. Failure to submit results within the required 72-hour period (48-hour turnaround with 24-hour grace period) may result in the District temporarily stopping the applicable remediation project until results are received. Continued failure may also result in the termination of the contract.

Copies of the personal air sampling results, along with laboratory accreditation, shall be submitted to the WCSD ES&A and District's independent third-party consultant as noted above.

The District's independent third-party consultant reserves the right to halt work or increase respiratory protection if personal air samples are not submitted in a timely manner, or if area air sampling shows current respiratory protection does not sufficiently protect employees.

Security and Safety

The Contractor is responsible for security of all equipment and safety of all employees. Contractor shall provide any storage containers or security needed for tools and equipment if they are to be left onsite. Contractor shall coordinate with WCSD Site Facilities Coordinator or WCSD Project Manager for placement of any storage container brought onsite.

Contractor is responsible for all worker safety and following all applicable regulations, namely Nevada and Federal OSHA. Contractor or their designated supervised shall hold a safety meeting on the first day of the project that addresses all safety hazards workers may encounter. Safety meetings shall be held at least weekly thereafter, or in the event that job hazards change, or an accident occurs. The safety meeting topics shall be documented and all attendees sign the document for recordkeeping. A copy of the safety meeting shall be provided to the District's independent third-party consultant.

Occupancy

As noted previously, occupancy of the project area will be limited to the lead remediation contractor, WCSD ES&A staff, and District's independent third-party consultant once lead activities are ready to commence. Once the area has been cleared, other parties may occupy. Emergency services may also occupy areas in the event of an emergency during the project.

Challenge Testing

All HEPA-filtered equipment to be used on this project shall be challenge tested (DOP or equivalent) within the previous 30 days of project start date. Copies of the challenge testing results shall be provided to the WCSD ES&A and/or District's independent third-party consultant.

Decontamination Requirements

A decontamination area shall be sited adjacent to the regulated work area. This area shall be large enough to accommodate a washing area for personal hygiene, a clean area for donning personal protection (PPE) equipment and storage of street clothes/personal items. The decontamination area shall have a 6-mil polyethylene drop sheet and privacy screens shall be installed as needed.

Wash facilities shall include antibacterial wipes (hand-wipes), soap, and clean towels. If street clothes are worn under PPE, a HEPA vacuum shall be made available to decontaminate clothing. If water is used for decontamination, lead-contaminated water shall be captured for waste characterization and proper disposal. A labeled waste bag/container shall be available for collection, characterization, and proper disposal of contaminated PPE.

The contractor is responsible for prohibiting any eating or drinking by their employees in the regulated work area and the decontamination area. Workers shall completely decontaminate and exit the area prior to consumption of any food or drink.

Regulated Area Signage

Lead Hazard signs and/or tape shall be posted at all entrances to a regulated area. Signage will be posted after a pre-start visual is passed and work may begin in the regulated area, but no work will start until all signs are posted.

Lead signage shall meet the revised requirements for lead set forth in 29 CFR 1926.62(m).

Containment and Disturbance Procedure Requirements – Lead Component Removal

All poly used on this project shall be 6-mil in thickness and fire-retardant. **No exterior containment area may remain in place past the work shift that the lead work is performed in.**

The following procedures outline the requirements for removal of painted components:

1. The contractor shall limit and control access to the work area using lead hazard signs and caution tape. Required regulated area lead hazard signage shall be placed 20 feet away from the work area. Personal Protection Equipment must be worn within this regulated area. Caution tape shall be used to demarcate a buffer area 10 feet past the regulated area signage to ensure authorized access control is maintained. Contractor shall provide pylons or similar as needed for mounting of barrier tape(s) to establish areas.
2. Critical barriers shall be applied to all openings (windows, doors, or otherwise) within 20 feet of the work area, if applicable.
3. One layer of 6-mil poly shall be placed on the ground and extend out 10 feet in each direction from the location of lead disturbance.
4. Poly shall be weighed down or secured to prevent movement or billowing and the creation of a trip hazard.
5. A decontamination area shall be sited adjacent to the regulated work area. Requirements for the Decontamination Area are listed above.
6. Metal components / framing of the play structure shall be removed by either removing concrete footing and removing structure completely intact or by cutting structure into manageable sections for removal. Workers shall attempt to make cuts where paints are not located and/or thinner to limit potential lead dust release.
7. Cutting of surfaces shall be performed using equipment that has a shroud with HEPA-vacuum attachment to provide sufficient local exhaust at the point of the cut to prevent the release of visible emissions or paint chip debris into worker breathing zones. Torch cutting of components is not allowed on this project.
8. A build-up of waste or debris within the work area is prohibited. Contractor workers shall assure the area is kept free of waste bags, paint chips, dust, or other debris as work progresses to prevent the crushing of lead debris into finer lead dust.
9. At the conclusion of lead disturbance, the poly drop sheet shall be wet-wiped and HEPA-vacuumed clean of all debris and dust.
10. After final cleaning, the Contractor's supervisor shall perform a visual inspection to determine if the work area is ready for a visual clearance inspection, and the supervisor shall notify District ES&A personnel or District's independent third-party consultant when the work area is ready.
11. A final visual clearance inspection will be performed by the District's ES&A personnel or District's independent third-party consultant. The criteria for passing the final visual clearance shall be the completion of removal of components and absence of any dust or debris within the regulated work area. All waste and debris shall be properly packaged and removed from the regulated area prior to this final inspection.
12. All waste shall be double-bagged in clear, 6-mil poly waste bags, or double-wrapped in 6-mil poly sheeting (see disposal section below).
13. Once the final visual inspection is passed, poly drop sheets shall be folded-in on themselves carefully and disposed of with waste. No poly drop sheets may be used beyond their initial work area and day.

Disposal Requirements

Contractor is responsible for the waste characterization profiling of all lead waste to be disposed of. Copies of the laboratory results, including chain-of-custody, must be provided to WCSD ES&A or independent third-party consultant prior to disposal. Lead-containing materials may be recycled, but a letter signed by the recycling facility acknowledging the lead content of materials being received must be provided by Contractor prior to removal of such materials from the site.

Contractor will need to provide a lockable waste bin or enclosed trailer for all waste created on this project. The waste bin or enclosed trailer will need to be labeled with lead signage once the waste is loaded into the bin. Waste bins shall be lined with one layer of 6-mil poly prior to waste being loaded.

Lead waste will not be allowed to remain onsite overnight unsecured. Waste must be taken offsite daily or secured in a lockable waste bin or enclosed trailer as described above.

Waste bins and trailers will need to arrive onsite clean of debris or any other waste and must be in proper functioning order. Waste and contractor equipment or supplies may not be stored within the same container, The waste container shall be locked at all times, unless active waste loading is taking place.

Waste bins may be rejected by WCSD ES&A staff or District's independent third-party consultant if these conditions are not met, with no extra charge to the District.

Clearance

At the conclusion of remediation within a regulated area, a final visual clearance inspection will be performed by the District's independent third-party consultant. The criteria for a successful final clearance visual inspection are that all indicated components have been removed and the work area will need to be free of all dust and debris.

In the event that a potential lead hazard has been created by a contractor, such as improper disturbance of painted surfaces outside of a contained area, the District's ES&A staff or independent third-party consultant will collect dust wipe samples to verify conditions. If a lead hazard has been created, the contractor performing the improper disturbance will be responsible for all cleaning costs required for the lead abatement contractor to remediate the hazard, including costs for collection of clearance dust wipe samples to document that the lead hazard has been remediated.

Created by: Daniel Prado, FACS, IJPM-2057, US EPA LBP-R-1214705-2
Reviewed by: Chris Chipponeri, FACS, IJPM-1410, US EP LBP-R-128230-3
Date: March 24, 2025